

RoHS Comp.
Halogen Free

<h1>承認書</h1>
<h2>APPROVAL SHEET</h2>

Specifications description : **CAP PL 100uF 16V  $\phi$  6.3\*4.5mm**  
**SMD  $\pm$ 20%, 105°C 2000hrs**

---

APAQ P/N : **160AVEA101M0645L20**

---

Customer P/N :

---

Date	Approved by	Checked by
	陳明宗	梁名琮

Approved by Customer  
(Signing or stamping here) :

---

Approved Date :

---



鈺邦科技股份有限公司  
**APAQ TECHNOLOGY CO., LTD**

竹南科學園區  
苗栗縣竹南鎮科東三路 2&6 號 4 樓  
4F., No.2 & 6, Kedong 3rd Rd., Chunan  
Science Park, Miaoli County 350,  
Taiwan ,(R.O.C.)

# AP-CON AVEA SERIES SPECIFICATION

## 1. Application

This specification shall be specified to conductive polymer aluminum solid electrolytic capacitors of AVEA series.

## 2. Composition of part number

2R5            AVEA            331            M            0606            LXX  
 Rated voltage   Series code   Capacitance   Cap tolerance   Size code   Special code

### 2.1 Rated voltage code

Table 1 Rated voltage and surge voltage

Rated voltage code	Rated voltage (V)	Surge voltage (V)
2R5	2.5	2.9
6R3	6.3	7.2
100	10	11.5
160	16	18.4
250	25	28.8

### 2.2 Capacitance code

Table 2 Rated capacitance

Capacitance code	Capacitance (uF)
3R3	3.3
100	10
821	820
122	1200

### 2.3 Capacitance tolerance code

Table 3 Capacitance tolerance

Cap tolerance code	Cap tolerance
M	±20%

THIS DRAWINGS AND SPECIFICATIONS ARE THE PROPERTY OF APAQ TECHNOLOGY CO. LTD AND SHALL NOT BE REPRODUCT OR USED AS THE BASIC FOR THE MANUFACTURE OR SALE OF APPARATUS OR DEVICES WITHOUT PERMISSION.



鈺邦科技股份有限公司

APAQ TECHNOLOGY CO., LTD

DESIGNED BY : 陳明宗

DRAWN BY : 呂姿儀

CHECKED BY : 梁名琮

APPROVED BY : 陳明宗

TITLE : AP-CON AVEA SERIES SPECIFICATION

DOCUMENT NO.

MES010900

REV

A0

## 2.4 Size code

Table 4 Dimension of radial type capacitors

Size code	Diameter (mm)	Case length (mm)
0506	5	5.8
0645	6.3	4.5
0606	6.3	5.8
0608	6.3	7.5
0610	6.3	9.7
0807	8	6.8
0810	8	9.7
0812	8	12
1010	10	10.2
1012	10	12.3

## 2.5 Special code

Special code	Remark
LXX	L10 : Leakage Current 0.1 CV

## 3. Rating

### 3.1 Category temperature range

-55 to +105 °C

### 3.2 Surge voltage

Rated voltage x 1.15

### 3.3 Rated ripple current

Rated ripple current shall be in accordance with standard ratings list. These current are rms values for sine wave of 100kHz at 105 °C.

### 3.4 Standard ratings

Table 5 Standard ratings

WV/Vdc (SV)	Cap (μF)	Size Code	Leakage Current (μA)	tanδ	ESR (mΩmax/20°C, 100k to 300kHz)	Rated Ripple Current (mArms/ 105°C/100kHz)	Part No.
16 (18.4)	100	0645	320	0.12	40	2,450	160AVEA101M0645L10

THIS DRAWINGS AND SPECIFICATIONS ARE THE PROPERTY OF APAQ TECHNOLOGY CO. LTD AND SHALL NOT BE REPRODUCT OR USED AS THE BASIC FOR THE MANUFACTURE OR SALE OF APPARATUS OR DEVICES WITHOUT PERMISSION.



鈺邦科技股份有限公司

APAQ TECHNOLOGY CO., LTD

DESIGNED BY : 陳明宗

DRAWN BY : 呂姿儀

CHECKED BY : 梁名琮

APPROVED BY : 陳明宗

TITLE : AP-CON AVEA SERIES SPECIFICATION

DOCUMENT  
NO.

MES010900

REV

A0

#### 4. Construction and dimensions.

##### 4.1 Construction

Vertical type capacitors shall be enclosed wound element, where anode and cathode foils with lead wire termination shall be wound together with separator, with conductive polymer electrolyte in a plastic coated aluminum case and sealed up tightly with rubber.

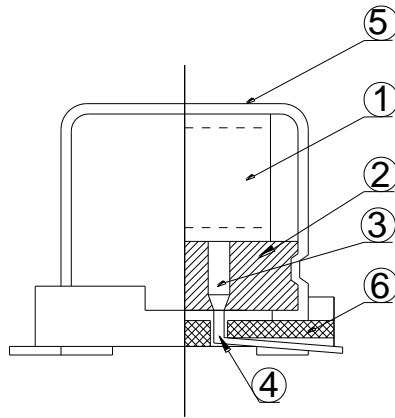

Fig. 1 Cross-section view

Table 6 Construction

Compositions		Materials
1	Element	Anode foil Cathode foil Separator Fixing tape
	2	Seal
	3	Aluminum tab
	4	Lead wire
5	Case	
6	Base plate	

THIS DRAWINGS AND SPECIFICATIONS ARE THE PROPERTY OF APAQ TECHNOLOGY CO. LTD AND SHALL NOT BE REPRODUCT OR USED AS THE BASIC FOR THE MANUFACTURE OR SALE OF APPARATUS OR DEVICES WITHOUT PERMISSION.



鈺邦科技股份有限公司

APAQ TECHNOLOGY CO., LTD

DESIGNED BY : 陳明宗

DRAWN BY : 呂姿儀

CHECKED BY : 梁名琮

APPROVED BY : 陳明宗

TITLE : AP-CON AVEA SERIES SPECIFICATION

DOCUMENT NO.

MES010900

REV

A0

#### 4.2 Outer dimensions

Outer dimensions shall be in accordance with Fig. 2, and the dimensions in each size shall be specified on Table 7.

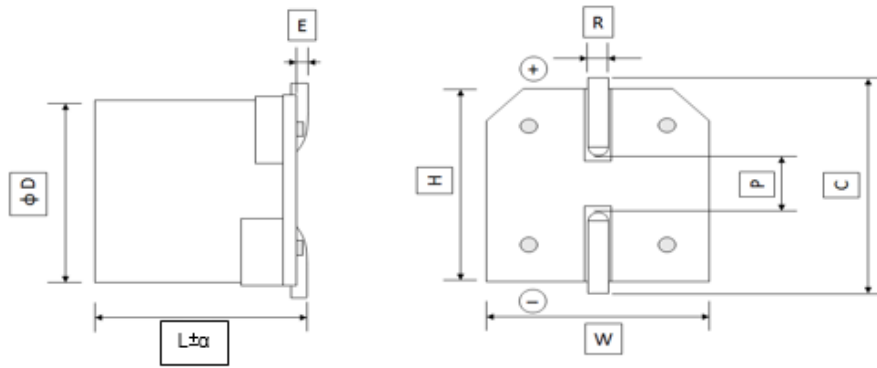

Fig. 2 Dimension

Table 7 Dimension

Size code	$\phi D \pm 0.5$ (mm)	L (mm)	$\alpha$ (mm)	E (mm)	$W \pm 0.2$ (mm)	$H \pm 0.2$ (mm)	$C \pm 0.2$ (mm)	R (mm)	$P \pm 0.3$ (mm)
0506	5	5.8	$\pm 0.2$	0.00~0.20	5.3	5.3	6	0.5~0.8	1.4
0645	6.3	4.5	-0.2~+0.1	0.00~0.20	6.6	6.6	7.3	0.5~0.8	2.1
0606	6.3	5.8	$\pm 0.2$	0.00~0.20	6.6	6.6	7.3	0.5~0.8	2.1
0608	6.3	7.5	$\pm 0.5$	0.00~0.20	6.6	6.6	7.3	0.5~0.8	2.1
0610	6.3	9.7	$\pm 0.3$	0.00~0.20	6.6	6.6	7.3	0.6~0.9	2.1
0807	8	6.8	$\pm 0.2$	0.00~0.20	8.3	8.3	9	0.8~1.1	2.9
0810	8	9.7	$\pm 0.3$	0.00~0.20	8.3	8.3	9	0.8~1.1	2.9
0812	8	12	$\pm 0.5$	0.00~0.20	8.3	8.3	9	0.8~1.1	3.2
1010	10	10.2	$\pm 0.3$	0.00~0.20	10.3	10.3	11	0.8~1.1	4.6
1012	10	12.3	$\pm 0.2$	0.00~0.20	10.3	10.3	11	0.8~1.1	4.6

#### 5. Marking

The following items shall be marked on each capacitor, as showed in Fig. 3.

- (1) Polarity
- (2) Series
- (3) Year code: A-2020(WX),B-2021(WX),C-2022(WX)  
N-2020(HB),O-2021(HB),P-2022(HB)
- (4) Production period code
- (5) Manufacturer's identification mark
- (6) Rated capacitance
- (7) Rated voltage
- (8) The color of marking ink is Red

THIS DRAWINGS AND SPECIFICATIONS ARE THE PROPERTY OF APAQ TECHNOLOGY CO. LTD AND SHALL NOT BE REPRODUCT OR USED AS THE BASIC FOR THE MANUFACTURE OR SALE OF APPARATUS OR DEVICES WITHOUT PERMISSION.



鈺邦科技股份有限公司

APAQ TECHNOLOGY CO., LTD

DESIGNED BY : 陳明宗

DRAWN BY : 呂姿儀

CHECKED BY : 梁名琮

APPROVED BY : 陳明宗

TITLE : AP-CON AVEA SERIES SPECIFICATION

DOCUMENT NO.

MES010900

REV

A0

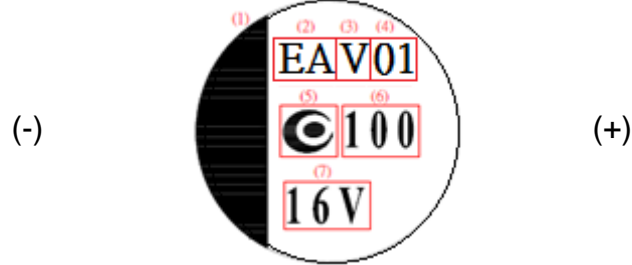

Figure 3 Marking

## 6. Reflow soldering

Soldering condition (temperature and time) should be within the following ranges.

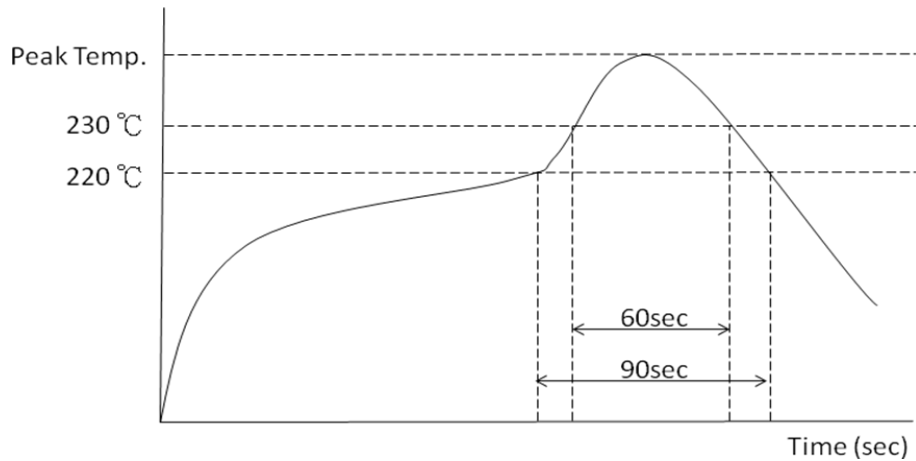

Figure 4 Reflow profile

Table 8 Recommended condition

Peak temperature (max)	260°C
220°C over time (max)	90sec
230°C over time (max)	60sec
Reflow number	Only 2 time

## 7. Soldering pad dimensions

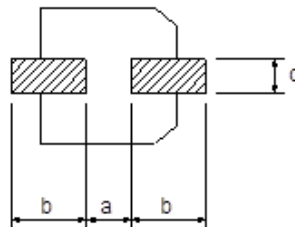

Figure 5 Soldering pad

THIS DRAWINGS AND SPECIFICATIONS ARE THE PROPERTY OF APAQ TECHNOLOGY CO. LTD AND SHALL NOT BE REPRODUCT OR USED AS THE BASIC FOR THE MANUFACTURE OR SALE OF APPARATUS OR DEVICES WITHOUT PERMISSION.



鈺邦科技股份有限公司

APAQ TECHNOLOGY CO., LTD

DESIGNED BY : 陳明宗

DRAWN BY : 呂姿儀

CHECKED BY : 梁名琮

APPROVED BY : 陳明宗

TITLE : AP-CON AVEA SERIES SPECIFICATION

DOCUMENT NO.

MES010900

REV

A0

Table 9 Recommended pad dimensions

Size code	a	b	c
φ5	1.4	3	1.6
φ6	2.1	3.5	1.6
φ8	2.8	4.2	1.9
φ10	4.3	4.4	1.9

8. Taping packing and label marking

8.1 Carrier tape dimensions

(a) Normal

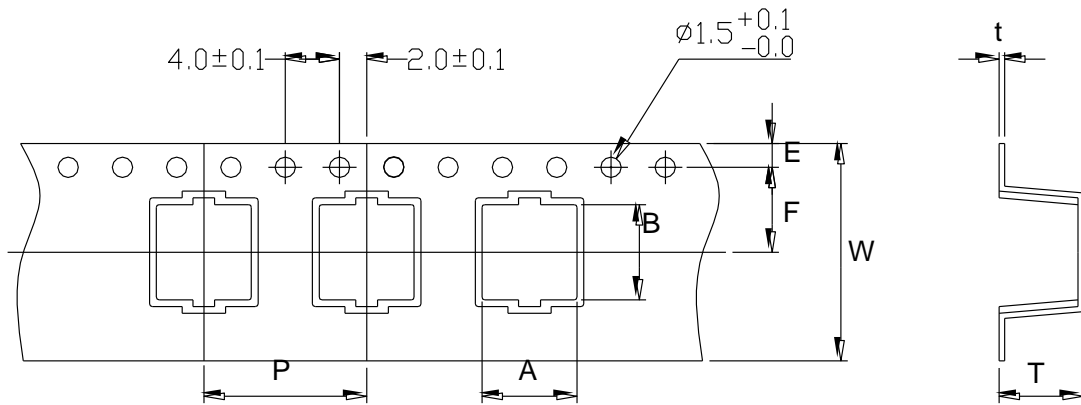

(b) 0645 · 0606

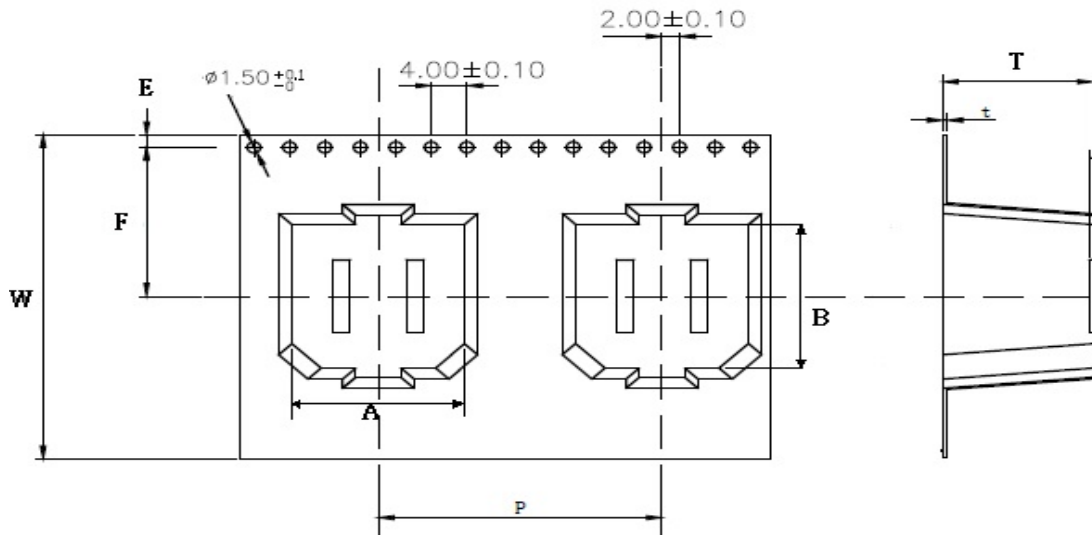

Fig. 6 Carrier tape

THIS DRAWINGS AND SPECIFICATIONS ARE THE PROPERTY OF APAQ TECHNOLOGY CO. LTD AND SHALL NOT BE REPRODUCE OR USED AS THE BASIC FOR THE MANUFACTURE OR SALE OF APPARATUS OR DEVICES WITHOUT PERMISSION.



鈺邦科技股份有限公司

APAQ TECHNOLOGY CO., LTD

DESIGNED BY : 陳明宗

DRAWN BY : 呂姿儀

CHECKED BY : 梁名琮

APPROVED BY : 陳明宗

TITLE : AP-CON AVEA SERIES SPECIFICATION

DOCUMENT NO.

MES010900

REV

A0

Table 10 Carrier tape dimensions

Size code	W±0.3 (mm)	A±0.2 (mm)	B±0.2 (mm)	F±0.1 (mm)	E±0.1 (mm)	P±0.1 (mm)	T±0.2 (mm)	t ±0.05 (mm)
0506	12	5.7	5.7	5.5	1.75	12	6.2	0.4
0645	16	6.8	6.8	7.5	1.75	12	4.8	0.4
0606	16	6.8	6.8	7.5	1.75	12	6.3	0.4
0608	16	7	7	7.5	1.75	12	8.2	0.5
0610	16	7	7	7.5	1.75	12	10	0.5
0807	24	8.7	8.7	11.5	1.75	12	7.2	0.5
0810	24	8.7	8.7	11.5	1.75	16	10	0.5
0812	24	8.7	8.7	11.5	1.75	16	12	0.5
1010	24	10.7	10.7	11.5	1.75	16	11	0.5
1012	24	10.7	10.7	11.5	1.75	16	13	0.5

8.2 Reel dimensions

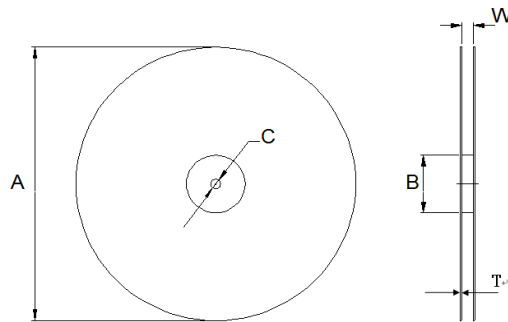

Fig. 7 Reel

Table 11 Reel dimensions

Size code	A ± 2 (mm)	B ± 0.5 (mm)	C±0.5 (mm)	W±0.8 (mm)	T±0.3 (mm)
φ5	381	100	13	13.5	2.5
φ6	381	100	13	16.5	2.5
φ8	381	100	13	25.9	2.5
φ10	381	100	13	25.9	2.5

THIS DRAWINGS AND SPECIFICATIONS ARE THE PROPERTY OF APAQ TECHNOLOGY CO. LTD AND SHALL NOT BE REPRODUCT OR USED AS THE BASIC FOR THE MANUFACTURE OR SALE OF APPARATUS OR DEVICES WITHOUT PERMISSION.



鈺邦科技股份有限公司

APAQ TECHNOLOGY CO., LTD

DESIGNED BY : 陳明宗

DRAWN BY : 呂姿儀

CHECKED BY : 梁名琮

APPROVED BY : 陳明宗

TITLE : AP-CON AVEA SERIES SPECIFICATION

DOCUMENT NO.

MES010900

REV

A0



### 8.3 Taping method and polarity

(a) 5、6、8 phi

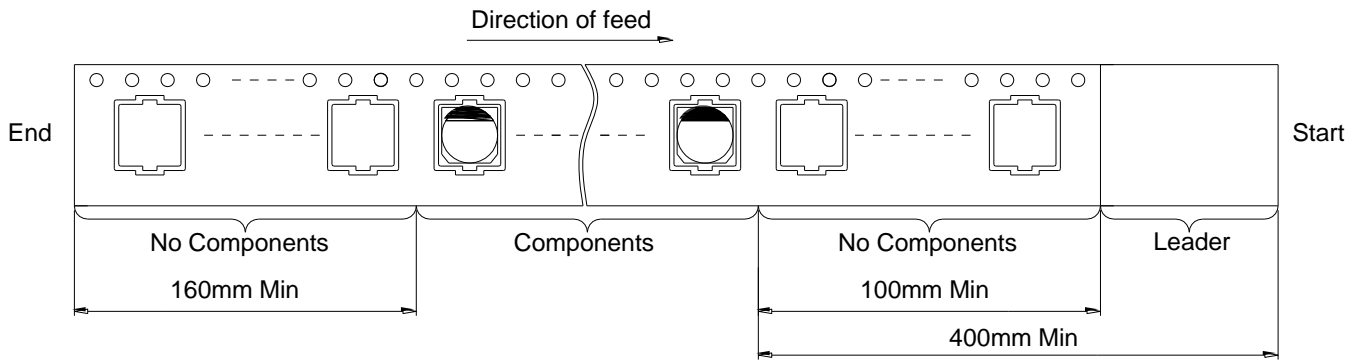

(b) 10 phi

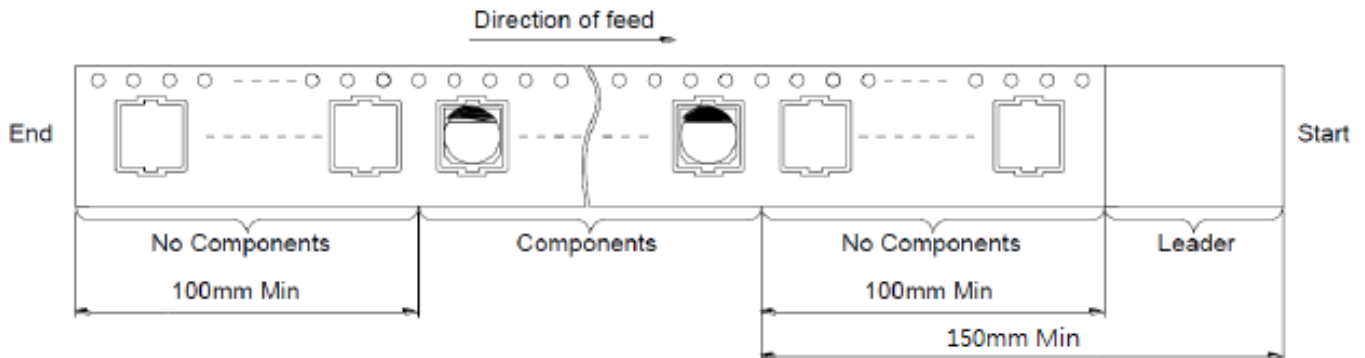

Fig. 8 Taping method and polarity

### 8.4 Label Marking

The label specified as follows shall be put on the side of reel.

- (1) Part No.
- (2) Quantity.
- (3) Lot No.

THIS DRAWINGS AND SPECIFICATIONS ARE THE PROPERTY OF APAQ TECHNOLOGY CO. LTD AND SHALL NOT BE REPRODUCT OR USED AS THE BASIC FOR THE MANUFACTURE OR SALE OF APPARATUS OR DEVICES WITHOUT PERMISSION.



鈺邦科技股份有限公司

APAQ TECHNOLOGY CO., LTD

DESIGNED BY : 陳明宗

DRAWN BY : 呂姿儀

CHECKED BY : 梁名琮

APPROVED BY : 陳明宗

TITLE : AP-CON AVEA SERIES SPECIFICATION

DOCUMENT NO.

MES010900

REV

A0

## 8.5 Package

The capacitors should be packed in the following quantities listed in Table 12

Table 12 Quantity of package

Case size	1 Reel	1 Box
0506	1.2K pcs	7.2K pcs(6 reels)
0645	1.5K pcs	9K pcs(6 reels)
0606	1.2k pcs	7.2K pcs(6 reels)
0608	900 pcs	5.4k pcs(6 reels)
0610	750 pcs	4.5K pcs(6 reels)
0807	1K pcs	5K pcs(5 reels)
0810	500 pcs	2.5K pcs(5 reels)
0812	400 pcs	2K pcs(5 reels)
1010	500 pcs	2.5k pcs(5 reels)
1012	450 pcs	2.25K pcs(5 reels)

## 9. The electrical and mechanical performance and testing method

### 9.1 Measurement condition

Each measurement shall be conducted at a temperature of 15 to 35°C, and relative humidity of 45 to 85%. Furthermore, these measurements shall be preferably conducted at a temperature of 20±2°C, and relative humidity of 60 to 70%, while the capacitors shall be kept enough time in the measuring temperature.

### 9.2 Voltage treatment

If leakage current is doubtful, measure it after performing voltage treatment, which shall contain the following steps:

- (1) Applied DC rated voltage to the capacitors for 60 minutes at 105±2°C.
- (2) Cooled down to room temperature with applying voltage.
- (3) Discharged through a resistor of approximately 1Ω/V.

### 9.3 Electrical performance

#### 9.3.1 Tolerance on rated capacitance

Rated capacitance shall meet within -20% to +20% (M) tolerance against the rated capacitance measured at 120Hz±10% at 20±2°C.

THIS DRAWINGS AND SPECIFICATIONS ARE THE PROPERTY OF APAQ TECHNOLOGY CO. LTD AND SHALL NOT BE REPRODUCT OR USED AS THE BASIC FOR THE MANUFACTURE OR SALE OF APPARATUS OR DEVICES WITHOUT PERMISSION.



鈺邦科技股份有限公司

APAQ TECHNOLOGY CO., LTD

DESIGNED BY : 陳明宗

DRAWN BY : 呂姿儀

CHECKED BY : 梁名琮

APPROVED BY : 陳明宗

TITLE : AP-CON AVEA SERIES SPECIFICATION

DOCUMENT NO.

MES010900

REV

A0

9.3.2 Leakage current

DC rated voltage shall be applied between anode and cathode lead wire terminations of a capacitor through 1kΩ protective resistance, and the leakage current shall be less than or equal to the value listed in table 5 after 2 minutes with the voltage reaching the rated value at 20±2°C.

If the value is doubtful, measure the leakage current after performing voltage treatment as described in section 9.2.

9.3.3 Tangent of loss angle (tanδ)

Tanδ values shall be less than or equal to 0.12 measured at 120Hz±10% at 20±2°C.

9.3.4 Equivalent Series Resistance (ESR)

ESR at 100kHz measured under the following conditions listed in Table 13 shall be less than or equal to the value in Table 5.

Table 13 Measurement requirement of ESR

Equipment	Agilent Technology 4263B or equivalent
Test Fixture	Agilent Technology 16047E or equivalent
Compensation	Short and Open compensation would be required. Short correction is performed using the shorting plate made of 0.5 thickness copper plate with gold coating.
Signal Level	500mV
Frequency	100kHz
Measurement Point	Point of lead wire within 1mm form the body

9.3.5 Impedance at high and low temperature

Impedance at 100kHz at -55±3°C or 105±2°C shall meet the values listed in Table 14.

Table 14 Impedance at low or high temperature

Impedance ratio	Performance
Z(-55°C)/Z(+20°C)	≤ 1.25
Z(105°C)/Z(+20°C)	≤ 1.25

THIS DRAWINGS AND SPECIFICATIONS ARE THE PROPERTY OF APAQ TECHNOLOGY CO. LTD AND SHALL NOT BE REPRODUCT OR USED AS THE BASIC FOR THE MANUFACTURE OR SALE OF APPARATUS OR DEVICES WITHOUT PERMISSION.



鈺邦科技股份有限公司

APAQ TECHNOLOGY CO., LTD

DESIGNED BY : 陳明宗

DRAWN BY : 呂姿儀

CHECKED BY : 梁名琮

APPROVED BY : 陳明宗

TITLE : AP-CON AVEA SERIES SPECIFICATION

DOCUMENT NO.

MES010900

REV

A0

## 9.4 Mechanical performance

### 9.4.1 Adhesion by soldering

A force of 5N shall be applied for 10 seconds to the capacitor, which was mounted on a print circuit board, in the perpendicular direction to the seal side of the capacitor. After this test, the soldered terminals shall not be damaged.

### 9.4.2 Vibration

Vibration cycle should vary from 10 to 55Hz with total amplitude of 1.5mm and return to 10Hz in about 1 minute. Vibration applied to a capacitor should be three directions, which each perpendicular to the other two as longitudinal axis of capacitor set as z axis, and last for 2 hours in each direction. During this test, measured electrical value shall be stabilized when that capacitor is measured 5 times within 30 minutes before completion of test, and the appearance shall not appear any remarkable abnormality. Capacitance change shall be within  $\pm 10\%$  of the initial measured value.

### 9.4.3 Solder ability

The lead surface shall be immersed for  $2\pm 0.5$  seconds in the flux of ethanol or isopropyl alcohol solution ( $25\pm 2\%$ ) of colophonium. Then that lead surface shall be immersed to a solder (H60A, H60S or H63A) of  $235\pm 5^\circ\text{C}$  and up to the point 1.5 to 2.0mm from the body and kept for  $2\pm 0.5$  seconds, and pulling it out. After this test, solder shall cover at least  $3/4$  of the lead surface immersed.

### 9.4.4 Soldering heat

After the capacitors are soldered by the recommended soldering conditions below, the tests of the item Humidity resistance and Load life shall be conducted. After this test, the capacitors shall satisfy their test criteria.

## 9.5 Environmental performance

### 9.5.1 Damp heat, steady state

A capacitor shall be subjected to a temperature of  $60\pm 2^\circ\text{C}$  and relative humidity of 90 to 95% with voltage applied for a period of  $1000+48/-0$  hours. Then that capacitor shall be taken out from the above condition to a temperature of  $20^\circ\text{C}$  and it shall meet the characteristics in Table 15.

THIS DRAWINGS AND SPECIFICATIONS ARE THE PROPERTY OF APAQ TECHNOLOGY CO. LTD AND SHALL NOT BE REPRODUCE OR USED AS THE BASIC FOR THE MANUFACTURE OR SALE OF APPARATUS OR DEVICES WITHOUT PERMISSION.		 鈺邦科技股份有限公司 APAQ TECHNOLOGY CO., LTD	
DESIGNED BY : 陳明宗	DRAWN BY : 呂姿儀	CHECKED BY : 梁名琮	APPROVED BY : 陳明宗
TITLE : AP-CON AVEA SERIES SPECIFICATION		DOCUMENT NO. MES010900	REV A0

Table 15 Damp heat performance

Characteristics	Performance
Appearance	No significant damage
Capacitance change	≤ ±20% of the initial value
tanδ	≤ 150% of the initial specified value
ESR	≤ 150% of the initial specified value
Leakage current	≤ the initial specified value

9.5.2 Endurance

A capacitor shall be subjected to a temperature of 105±2°C with test voltage applied for a period of 2,000+72/-0 hours and take out from the above condition to a temperature of 20°C. After this test, that capacitor shall meet the characteristics in Table 16.

Besides, the applied voltage shall increase up from 0V to test voltage step by step (maximum 5 minutes), and the impedance of the source shall be equal to about 3Ω/V.

Table 16 Endurance performance

Characteristics	Performance
Appearance	No significant damage
Capacitance change	≤ ±20% of the initial value
tanδ	≤ 150% of the initial specified value
ESR	≤ 150% of the initial specified value
Leakage current	≤ the initial specified value

9.5.3 Surge voltage

The following specifications in Table 17 shall be satisfied when the capacitors are restored to +20°C after the surge voltage is applied at a cycle of 360 seconds which consists charge for 30±5 seconds through a protective resistor of 1kΩ and discharge for 330 seconds, for 1000 cycles at 105±2°C.

Table 17 Surge voltage performance

Characteristics	Performance
Appearance	No significant damage
Capacitance change	≤ ±20% of the initial value
tanδ	≤ 150% of the initial specified value
ESR	≤ 150% of the initial specified value
Leakage current	≤ the initial specified value

THIS DRAWINGS AND SPECIFICATIONS ARE THE PROPERTY OF APAQ TECHNOLOGY CO. LTD AND SHALL NOT BE REPRODUCT OR USED AS THE BASIC FOR THE MANUFACTURE OR SALE OF APPARATUS OR DEVICES WITHOUT PERMISSION.



鈺邦科技股份有限公司

APAQ TECHNOLOGY CO., LTD

DESIGNED BY : 陳明宗

DRAWN BY : 呂姿儀

CHECKED BY : 梁名琮

APPROVED BY : 陳明宗

TITLE : AP-CON AVEA SERIES SPECIFICATION

DOCUMENT NO.

MES010900

REV

A0

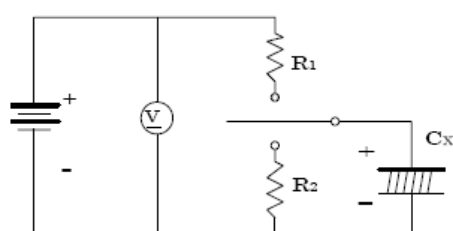

Ⓟ :DC voltmeter

R1 :Protective resistor 1kΩ

R2 :Discharging resistor 1kΩ

C<sub>x</sub> :Capacitor under test

Fig. 9 Surge voltage circuit

## 10. Instructions of Capacitors

### 10.1 Cautions on use of Capacitor

#### 10.1.1 Polarity

Solid electrolytic capacitors are polarized capacitors. Use capacitors after verifying their positive and negative polarities. If these capacitors are installed in the reverse polarity, its life may shorten because of increasing leakage current or short circuit.

10.1.2 Types of circuits in which capacitors are prohibited from being used AVEA series may be heated by soldering to increase in its leakage current slightly. This may have some influence on the characteristics capacitors in the following circuits.

- (1) Time constant circuit
- (2) Coupling circuit
- (3) High impedance voltage holding circuit
- (4) Connection of two or more capacitors in series for higher withstand voltage.

#### 10.1.3 Over voltage

If AVEA series is applied a voltage higher than the rated voltage for an instantaneous period, it may be defected due to short circuit. Note that the voltage over the rated voltage must not be applied to capacitors.

#### 10.1.4 Repeat of rapid charging and discharging

If AVEA series is used in a rapid charging and discharging circuit or receive the flow of excess rush current, its life may shorten by large leakage current or short circuit. The charging and discharging current through AVEA series should be less than 10A.

THIS DRAWINGS AND SPECIFICATIONS ARE THE PROPERTY OF APAQ TECHNOLOGY CO. LTD AND SHALL NOT BE REPRODUCT OR USED AS THE BASIC FOR THE MANUFACTURE OR SALE OF APPARATUS OR DEVICES WITHOUT PERMISSION.



鈺邦科技股份有限公司

APAQ TECHNOLOGY CO., LTD

DESIGNED BY : 陳明宗

DRAWN BY : 呂姿儀

CHECKED BY : 梁名琮

APPROVED BY : 陳明宗

TITLE : AP-CON AVEA SERIES SPECIFICATION

DOCUMENT NO.

MES010900

REV

A0

### 10.1.5 Reflow soldering

High soldering temperature and long soldering time will affect the characteristics of the capacitors. Use reflow soldering condition within the recommended range. Also, the temperature varies with the location and population of the components, the material and the thickness of printed circuit board. Verify temperature profiles prior to actual production run.

### 10.1.6 Use of capacitors for industrial equipment

When capacitors are used for industrial equipment, the circuits should be designed to have sufficient margins in the ratings of capacitors including capacitance and impedance. Without sufficient margins in the characteristics, the reliability of the capacitors may be reduced by their shorter life. Always contact us if you want to use capacitors for equipment affecting human lives such as space, aviation, atomic power, and medical devices. Never use capacitors for the used without our prior approval.

## 10.2 Notes on circuit designs for capacitors

### 10.2.1 Rating and performance

Use capacitors within the rating and performance ranges defined in the brochures and delivery specification of capacitors after checking the operating and installation environments.

### 10.2.2 Operating temperature

If AVEA series is used at a temperature higher than the upper specified temperature (105°C), its life may be remarkably shortened or the leakage current may increase to cause defective.

### 10.2.3 Ripple current

Never make current larger than the rated ripple current through AVEA series. If excess ripple current flows through AVEA series, internal heat may be generated largely to make its life shortened or cause it to be defected due to short circuit.

### 10.2.4 Leakage current

Depending on the reflow soldering conditions, the leakage current of AVEA series may increase slightly. The application of DC voltage enables the capacitors to be repaired by itself. This leads the leakage current to be smaller gradually. The leakage current can be reduced fast if the DC voltage, which is less than the rating voltage, is applied at the temperature close to the upper specified temperature.

THIS DRAWINGS AND SPECIFICATIONS ARE THE PROPERTY OF APAQ TECHNOLOGY CO. LTD AND SHALL NOT BE REPRODUCE OR USED AS THE BASIC FOR THE MANUFACTURE OR SALE OF APPARATUS OR DEVICES WITHOUT PERMISSION.		 鈺邦科技股份有限公司 APAQ TECHNOLOGY CO., LTD	
DESIGNED BY : 陳明宗	DRAWN BY : 呂姿儀	CHECKED BY : 梁名琮	APPROVED BY : 陳明宗
TITLE : AP-CON AVEA SERIES SPECIFICATION		DOCUMENT NO. MES010900	REV A0

### 10.2.5 Applied voltage

Do not apply voltages exceeding the full rated voltage. If such voltage is applied, it may cause short circuit even though it is just a moment.

- (1) Sum of DC voltage and the peak of ripple voltage AC voltage shall not exceed the rated voltage or category voltage.
- (2) The sum of the DC voltage plus the negative peak AC voltage shall not allow reverse voltage.
- (3) Do not apply reverse voltage.
- (4) For 25V products, the applied voltage shall follow the following figure as the temperature is higher than 85°C.

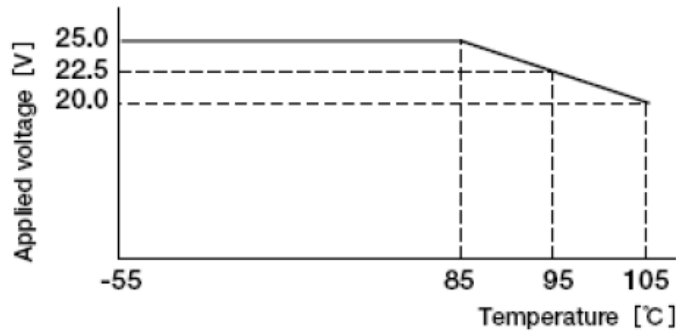

### 10.2.6 Failure mode

AVEA series contains a conductive polymer as material of cathode electrode. Therefore, like other solid electrolyte capacitors, the life ends mostly due to random failure mode, mainly short circuit. If a current continuously flow through the capacitor due to short circuit, the capacitor would be overheated higher than 300 °C and then aluminum case of the capacitor would be removed by increasing internal pressure due to the vaporization of materials.

### 10.2.7 Insulation

- (1) Plastic coated case of capacitors is not secured to insulate. Do not use capacitors in areas requiring insulation.
- (2) Isolate the case of AVEA series from the positive and negative terminals and adjacent circuit patterns.

THIS DRAWINGS AND SPECIFICATIONS ARE THE PROPERTY OF APAQ TECHNOLOGY CO. LTD AND SHALL NOT BE REPRODUCT OR USED AS THE BASIC FOR THE MANUFACTURE OR SALE OF APPARATUS OR DEVICES WITHOUT PERMISSION.



鈺邦科技股份有限公司

APAQ TECHNOLOGY CO., LTD

DESIGNED BY : 陳明宗

DRAWN BY : 呂姿儀

CHECKED BY : 梁名琮

APPROVED BY : 陳明宗

TITLE : AP-CON AVEA SERIES SPECIFICATION

DOCUMENT NO.

MES010900

REV

A0



### 10.2.8 Design of printed circuit board

Take note on the subjects when capacitors are installed on printed circuit boards:

- (1) For surface mount capacitors, design the copper pads/lands of a printed circuit board according to the catalog or product specifications.
- (2) Do not place heating components on boards to be close to capacitors or in the backside of them.

### 10.2.9 Parallel connection

If AVEA series is connected with another type of a capacitor in parallel, larger ripple current may flow through one of capacitors. Take the current balance among them into account in circuit designs.

### 10.2.10 Using temperature and frequency

The electric characteristics of capacitors depend on the variations of the ambient temperature and frequency. Check the variations in designing circuits.

## 10.3 Notes on installation of capacitors

### 10.3.1 Notes on pre-installation of capacitors

- (1) Do not reuse capacitors installed in a unit with the power supply turned on for another unit. No used capacitors shall be reused excluding those removed to measure their electric characteristics in periodical inspection.
- (2) If AVEA series stored for a long period may often increase in its leakage current, connect a resistor of approximately 1kΩ to the capacitors for voltage treatment.

### 10.3.2 Notes at installation of capacitors

- (1) Install capacitors in a unit after confirming that their ratings (rated capacitance and rated voltages) meet the conditions of the unit.
- (2) Install capacitors in the correct polarities.
- (3) Take care not to drop capacitors on floors. Do not use capacitors dropped on floors.
- (4) Do not deform capacitors to install them in units.
- (5) Note capacitors may be damaged by mechanical shocks caused by the vacuum head, component checker or centering operation of an automatic mounting machine.
- (6) Do not dip the body of a capacitor into the solder bath.
- (7) Do not solder capacitors more than once by reflow. Consult us for reflow-soldering them twice over.
- (8) Do not apply mechanical stress to the capacitor after soldering to the printed circuit board.
- (9) Do not use adhesives and coating materials containing halogenated solvents.

THIS DRAWINGS AND SPECIFICATIONS ARE THE PROPERTY OF APAQ TECHNOLOGY CO. LTD AND SHALL NOT BE REPRODUCE OR USED AS THE BASIC FOR THE MANUFACTURE OR SALE OF APPARATUS OR DEVICES WITHOUT PERMISSION.



鈺邦科技股份有限公司

APAQ TECHNOLOGY CO., LTD

DESIGNED BY : 陳明宗

DRAWN BY : 呂姿儀

CHECKED BY : 梁名琮

APPROVED BY : 陳明宗

TITLE : AP-CON AVEA SERIES SPECIFICATION

DOCUMENT NO.

MES010900

REV

A0

#### 10.4 Notes on use of capacitors in unit

- (1) Never make your fingers contact with the capacitor terminals.
- (2) Do not make capacitor terminals to be in contact with each other through a conductor.  
Do not put conductive liquid such as acid and alkali solutions on capacitors.
- (3) Confirm that the unit including capacitors is placed in proper conditions. Do not place the unit in the following areas:
  - (a) Area in which they are directly exposed to water, brine, or oil or in condensation status.
  - (b) Area filled with poisonous gases including hydrogen sulfide, sulfurous acid, nitrous acid, chlorine and ammonia.
  - (c) Area to which ultraviolet and/or radial rays are radiated.
- (4) Provide aging for a unit containing capacitors within the period defined for them.
- (5) It is recommended to use a unit containing capacitors in the normal temperature range of 15°C to 35°C and the normal humidity range of 75% or less.

#### 10.5 Action at emergency

- (1) At the occurrence of short circuit in AVEA series, some heat is generated from it if the short-current rather small. If the short current exceeds the above value, the capacitors are heated excessively. If so, turn off the power of the unit without your face and hands being close to the capacitors.
- (2) If you should expose your eyes to smoke from the capacitor or inhale it, immediately flush the open eyes and gargle with water.

#### 10.6 Storage

- (1) Store capacitors in an area in the temperature range between 15 °C to 35 °C and the relative humidity of 75% or less without direct sunshine. In addition, store them in the package states if possible.
- (2) SMD products are sealed in a special laminated aluminum bag. Use all capacitors once the bag is opened. Return unused capacitors to the bag, and seal it with a zipper.  
After the bag is opened, please use all capacitors within 6 month.
- (3) Store capacitors in an airtight bag to keep the terminals in good condition.
- (4) Store in a location where the capacitor is not exposed to ozone, ultraviolet radiation, or other radiation.
- (5) Never store capacitors in any area in which they are directly exposed to water, brine, or oil or in condensation status.

THIS DRAWINGS AND SPECIFICATIONS ARE THE PROPERTY OF APAQ TECHNOLOGY CO. LTD AND SHALL NOT BE REPRODUCT OR USED AS THE BASIC FOR THE MANUFACTURE OR SALE OF APPARATUS OR DEVICES WITHOUT PERMISSION.		 鈺邦科技股份有限公司 APAQ TECHNOLOGY CO., LTD	
DESIGNED BY : 陳明宗	DRAWN BY : 呂姿儀	CHECKED BY : 梁名琮	APPROVED BY : 陳明宗
TITLE : AP-CON AVEA SERIES SPECIFICATION		DOCUMENT NO. MES010900	REV
			A0

10.7 Exhaustion of capacitors

Capacitors are composed of organic compounds, resins and metals. Request an industrial dispose company to dispose of used Capacitors.

11. Export trade control ordinance

Item 41-4 in Section 2 of Appendix Table 1 (Section 49 in Chapter 1 of MITI' s Ordinance) and Item 7 in Section 7 of Appendix Table 1 (Section 6 in Chapter 6 of MITI' s Ordinance) state export regulations on pulse use capacitors (750V or higher) and high voltage use capacitors (5,000V or higher).

However, aluminum electrolytic capacitors are less than 750V in their voltage range, so that the regulations do not apply to the aluminum electrolytic capacitors.

THIS DRAWINGS AND SPECIFICATIONS ARE THE PROPERTY OF APAQ TECHNOLOGY CO. LTD AND SHALL NOT BE REPRODUCT OR USED AS THE BASIC FOR THE MANUFACTURE OR SALE OF APPARATUS OR DEVICES WITHOUT PERMISSION.		 鈺邦科技股份有限公司 APAQ TECHNOLOGY CO., LTD	
DESIGNED BY : 陳明宗	DRAWN BY : 呂姿儀	CHECKED BY : 梁名琮	APPROVED BY : 陳明宗
TITLE : AP-CON AVEA SERIES SPECIFICATION		DOCUMENT NO. MES010900	REV A0

## X-ON Electronics

Largest Supplier of Electrical and Electronic Components

*Click to view similar products for [Aluminium Organic Polymer Capacitors](#) category:*

*Click to view products by [APAQ](#) manufacturer:*

Other Similar products are found below :

[750-1809](#) [SEAU0A0102G](#) [MAL218297003E3](#) [APA0609471M006R](#) [APA0807561M004R](#) [APA0809331M016R](#) [APA0809561M010R](#)  
[APA0809821M004R](#) [APA0812102M006R](#) [APA0812122M004R](#) [APA0812471M016R](#) [APA0812561M016R](#) [HHXD630ARA330MJA0G](#)  
[HHXD350ARA270MF61G](#) [HHXD350ARA220ME61G](#) [HHXD350ARA101MHA0G](#) [HHXD500ARA101MJA0G](#) [HHXD250ARA101MF80G](#)  
[APXJ200ARA151MF61G](#) [HHXE250ARA331MJA0G](#) [RS81C271MDN1CG](#) [PM101M016E058PTR](#) [PM101M025E077PTR](#)  
[SPZ1EM221E10P25RAXXX](#) [APSE2R5ETD821MF08S](#) [SPZ1EM681F14O00RAXXX](#) [SPZ1AM102F11000RAXXX](#)  
[SPV1VM471G13O00RAXXX](#) [SPV1VM101E08O00RAXXX](#) [SPZ1VM821G18O00RAXXX](#) [SPV1HM331G15O00RAXXX](#)  
[SPZ1HM221G12O00RAXXX](#) [SPZ1CM471E11O00RAXXX](#) [SVZ1EM221E09E00RAXXX](#) [PM101M035E077PTR](#) [HV1A227M0605PZ](#)  
[HV1C107M0605PZ](#) [HV1C227M0607PZ](#) [HV1H107M0810PZ](#) [149EC920](#) [149EC921](#) [118EC222](#) [118EC229](#) [118EC247](#) [118EC333](#)  
[118EC220](#) [118EC221](#) [118EC225](#) [118EC235](#) [118EC227](#)