

AR257 CO₂, humidity and temperature transducer



- high-quality digital sensor for carbon dioxide (CO₂), relative humidity (RH) and temperature (T) in close rooms to improve the comfort and well-being of people staying there
- application in many fields and applications (for industrial, office and residential environments, inside buildings, e.g. HVAC installations, storage, production, transport, food sector, pharmacy, medicine, gardening, laboratories and others a probe integrated with the enclosure, external or on a stainless steel pipe
- probe integrated with the housing or external
- current output 0/4 ÷ 20 mA, voltage 0/2 ÷ 10 V or RS485 interface
- programmable processing ranges for measured values
- an LCD display with a keypad (option) that enables configuration of parameters
- configuration of parameters with the keypad, through the RS485 or PRG port (programmer AR956 or AR955) and free ARsoft-CFG software that enables quick setting and copying of all configuration parameters
- high stability of measurements
- protection rating IP65 provided by the enclosure which improves reliability of operation thanks to high resistance to penetration of water and dust and surface condensation of steam inside of the device, an IP20 probe
- atmospheric pressure 1013hPa) with the possibility of combining the calculated calculating the dew / frost point [°C], absolute humidity [g/m³] (calculations for values with the analogue output

Contents of set:

- a transducer
- a user instruction
- a warranty card

Available accessories:

- an AR956 (or AR955) programmer
- a RS485/USB converter

How to order

AR257 / □ / □ / □

Display	Code	Measurement probe type	Code
LCD*	LCD	integrated with the enclosure (standard)	-
without a display	-	external with a 1,5m wire*	2

Output	Code
output 0/4÷20 mA	I
output 0/2÷10V	U
interface RS485	RS485

* option for an extra fee

For examples:

Note: for the standard design, only the output type must be stated e.g.:

AR257 / I

AR257 without display, output 0/4÷20 mA, probe integrated with the enclosure

AR257 / LCD / U / 2

AR257 with a display, output 0/2÷10V, external probe with a 1,5m wire

TECHNICAL DATA (the detailed data can be found in the user's instruction)

Sensor	SCD30 made by Sensirion, an ABS cover (slot width 3mm)	
Measurement range	0÷10000 ppm, 0÷95 %RH, 0÷50 °C	
Measurement accuracy	CO ₂	typically ±(30ppm + 3%) in the entire measurement range (1)
	humidity	typically ±3 %RH in the entire measurement range (1)
	temperature	typically ±(0.4°C + 0.023 × (T [°C] - 25°C)) (1)
Additional errors	repeatability	±10 ppm, ±0,1 %RH, ±0,1 °C
	long-term stability	< 0,25 %RH / year, < 0.03 °C / year
	temperature stability	± 2.5 ppm / °C in temperature 0 ÷ 50 °C
Measurement period	2÷60s	
Response time (63%)	10s for measure humidity nad temperature, 20s for measure CO ₂ (for air flow > 3,6 km/h, 1m/s)	
Display (optional)	LCD, 4 digits 10 mm	
Outputs	current (active)	2 x 0/4÷20 mA, load R _L [Ω] < (U _{sup} - 5)V / 22 mA
	voltage	2 x 0/2÷10 V, load I _o < 4,5 mA (R _o > 2,5 kΩ)
	digital (not separated)	RS485, MODBUS-RTU (slave)
Power supply	for the 0/4÷20 mA	12÷36 Vdc, current consumption: max. ~45 mA + (I01+I02)
	for the 0/2÷10 V	18÷30 Vdc, current consumption without load outputs: max. ~35 mA
	version with RS485	9÷28 Vac lub 9÷36 Vdc, current consumption: max. ~60 mA
Operating conditions	air and neutral gases, do not pour water on the measurement probe	
	temperature and humidity	0÷50 °C, <95 %RH (no condensation)

NOTE: (1) - The sensor manufacturer performs a factory calibration and guarantees typical measuring accuracy for 90% of its products.

INSTALLATION DATA

Dimensions	58x94x35 mm (probe: 36x50x20 mm)
Material	polycarbonate (probe sheath: ABS)

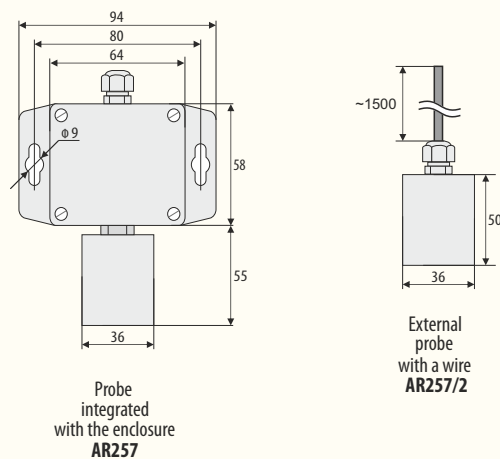

TERMINAL

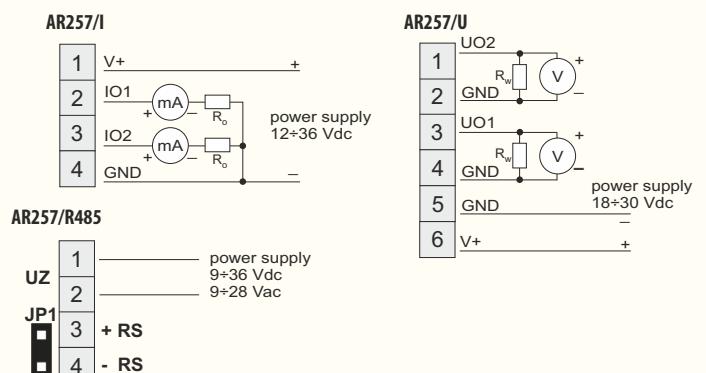

Version 1.0.0 2019-02-12

X-ON Electronics

Largest Supplier of Electrical and Electronic Components

Click to view similar products for [Environmental Test Equipment](#) category:

Click to view products by [Apar](#) manufacturer:

Other Similar products are found below :

[CW40](#) [F150C10E3DRT](#) [F150LTC20](#) [F150CD10E2](#) [F150L75](#) [F150LRS](#) [2837806](#) [4328074](#) [4366444](#) [S-11](#) [382153](#) [700PTP-1](#) [GEO-](#)
[CABLE-REEL-50M](#) [H115](#) [H300](#) [F150-SLC50](#) [TM-192](#) [TM-192D](#) [TM-414](#) [HS115](#) [SHG-02](#) [SHS-05](#) [SHG-01](#) [RH520-220](#) [TESTO 175-H1](#)
[0572 1754](#) [TESTO 830-T1](#) [0560 8311](#) [AX-5002](#) [AX-5003](#) [AX-B150](#) [AX-B180](#) [AX-B350](#) [AX-L230](#) [AX-PH02](#) [12227021](#) [12228657](#)
[12229067](#) [12230090](#) [7358958](#) [12230111](#) [12230146](#) [12230171](#) [12229190](#) [12228801](#) [12228665](#) [12228819](#) [12229360](#) [12230502](#) [12229378](#)
[12229394](#) [12229415](#)