

USER MANUAL



AR602.B



Bargraph
8-segment



AR652.B



AR642.B



Input
RTD, TC, mA
V, mV, Ω, BIN



Output
3(2) x P/SSR
1 x mA/V



Control
ON/OFF, PID
Program, Servo



Alarms
STB function
LATCH



Access protection
Password



Protection rating



RS485
MODBUS-RTU



USB
port COM
MODBUS-RTU



Ethernet
MODBUS-TCP
MQTT



Software
ARSOFT-CFG



AR682.B



AR632.B



AR662.B

UNIVERSAL PROGRAMMABLE CONTROLLERS



*Thank you for choosing our product.
This manual will enable proper handling, secure
and full use of the controller's capabilities.
Before assembling and starting the device please read
and understand this manual.*

If you have additional questions, please contact our technical consultant.

TABLE OF CONTENTS

1. SAFETY PRINCIPLES.....	3
2. ASSEMBLY RECOMMENDATIONS.....	3
3. GENERAL CHARACTERISTIC OF CONTROLLERS. ACCESSORIES AND KIT CONTENTS.....	3
4. TECHNICAL DATA.....	5
5. HOUSING DIMENSIONS AND ASSEMBLY DATA	6
6. DESCRIPTION OF CLAMPING RAILS AND ELECTRICAL CONNECTIONS	7
7. DESCRIPTION OF BUTTON FUNCTIONS AND LED DISPLAY.....	9
7.1. FUNCTION BUTTONS AND BINARY INPUTS	10
8. SETTING OF CONFIGURATION PARAMETERS	10
9. OUTPUT OPERATION CONFIGURATION.....	17
9.1. CHANGE OF SETPOINTS FOR OUTPUTS. QUICK ACCESS MENU.....	17
9.2. ANALOG OUTPUT (mA/V).....	17
9.3. PID TUNING	18
9.4. AUTOMATIC SELECTION OF PID PARAMETERS.....	19
9.5. PID PARAMETERS CORRECTION.....	20
9.6. PROGRAMMED WORK CHARACTERISTICS. SAMPLE CONFIGURATION.....	20
9.7. MIXING VALVE CONTROL. EXAMPLE CONFIGURATION	21
10. SIGNALING MESSAGES AND ERRORS	21
11. SERIAL COMMUNICATION. AVAILABLE SOFTWARE AND USB DRIVERS.....	22
11.1. MQTT PROTOCOL.....	23
11.2. MODBUS-TCP SERIAL TRANSMISSION PROTOCOL	24
11.3. RS485 COMMUNICATION INTERFACE (according to EIA RS-485)	25
11.4. MODBUS–RTU SERIAL TRANSMISSION PROTOCOL (SLAVE)	25
11.5. MAP OF DEVICE REGISTERS FOR MODBUS-RTU / TCP.....	26
12. OWN NOTES	27



Special attention should be paid to texts marked with this sign

The manufacturer reserves the right to make changes to the design and software of the device without deteriorating its technical parameters.

1. SAFETY RULES



Before using the device, please read this manual carefully, and:

- a) in order to avoid electric shock or damage to the device mechanical and electrical assembly should be commissioned to qualified personnel
- b) before turning on the power, make sure that all cables have been connected correctly
- c) before modifying cable connections, disconnect the voltage connected to the device
- d) ensure proper working conditions, compliant with the technical data of the device (*chapter 4*, supply voltage, humidity, temperature, etc.), do not expose the device to direct and strong influence of heat radiation

2. ASSEMBLY RECOMMENDATIONS



The device has been designed to provide an adequate level of resistance to most of the disturbances that can occur in industrial and home environments. In environments with an unknown level of interference, it is recommended to use the following measures to prevent any possible disruption of the device's operation:

- a) do not supply power to the device from the same lines as large capacity devices without proper mains filters
 - b) use shielding of power, sensor and signal wires, and screen-grounding should be single-point, made as close as possible to the device
 - c) avoid laying measuring (signal) wires in the immediate vicinity and parallel to power and supply cables
 - d) it is recommended to twist signal wires in pairs or use a ready UTP wire
 - e) Use the same cables for resistance sensors in a 3-wire connection
 - f) avoid the proximity of remotely controlled devices, electromagnetic meters, high power loads, loads with phase or group power control and other devices generating large impulse noise
 - g) ground or neutralize the metal rails on which the rail devices are mounted
- Before starting working with the device, remove the protective foil of the LED display.

3. GENERAL CHARACTERISTIC OF CONTROLLERS. ACCESSORIES AND KIT CONTENTS

- control and supervision of temperature and other physical values (humidity, pressure, flow, level, velocity, etc.) converted into a standard electrical signal
- configurable architecture enabling using in many fields and applications (industrial, heating, food, energy, etc.)
- **1 universal measurement input** (RTD, thermocouple TC, analog 0/4÷20mA, 0÷10V, 0÷60mV, 0÷2.5k Ω)
- **2** (1 for AR602.B) **function keys (F and SET)** and **digital input (BIN)** for quick change of the controller operating mode, separately programmable: control start/stop, manual/automatic mode for outputs, step change of the SP setpoint (day/night, i.e. **55-1** / **55-2**), with separate control parameters), keypad lock, reset of errors and alarms STB (LATCH), etc.
- **3** (2 + 1 LED alarm for AR602.B) **control/alarm outputs** of the on/off type (bi-state P/SSR) with independent functionalities and control algorithms:
 - **ON-OFF with hysteresis** (threshold characteristics for heating and cooling, bands within and out of range and with an offset for three-state control)
 - **PID (3 separate sets of parameters** to choose from), advanced functions of automatic selection of PID **smart logic** parameters
 - programmable operation characteristics (**process controller with timer**, up to **6 segments**, including 3 segments of **ramping** type-slope for heating/cooling or cooling/defrosting, 3 SP setpoints with ON-OFF or PID control, selection of the auxiliary output and its condition, displaying the remaining time for the entire segment or after exceeding the SP, etc.)
 - thermostat/controller/safety switch **STB** (alarm condition open or closed, erased F/SET/BIN, can also be used as an **alarm memory** of **LATCH** type, e.g. after exceeding the minimum, maximum or band)
 - the ability to control a three-way mixing valve with an actuator (step **control, servo**) with two pin inputs (open - close), implemented on outputs 1 and 2
 - **manual mode** (open control loop) with the initial value of the control signal (MV) taken from the current automatic mode or programmed by the user in the range of 0÷100%, also for sensor failure

- direct or reversed **copy of the output 1 state** (applies to outputs 2 and 3, it can be used, for example, to implement a **DPDT** change-over relay or to take over the function of a damaged P1)
- **limitation** of the maximum level of the output signal (**power**), also includes the connected mA/V analog output
- **analogue output 0/4÷20mA or 0/2÷10V** for adjustment or retransmission of measurements and setpoints:
 - download of the control parameters from any connected output/alarm (1, 2, 3), both in automatic and manual mode
 - shock-free (soft) switching of the output signal, e.g. after changing the manual/automatic mode or control start/stop
 - correction (calibration) of the range of changes of the output signal (shift for the extreme values allowing to obtain non-standard ranges, e.g. 2÷16mA or 1÷9V)
- wide range of supply voltages (**18÷265 Vac / 22÷350 Vdc**) and built-in power supply for object transducers **24Vdc/30mA**
- **clear LED** display with adjustable brightness and signaling of the operating status (messages, errors, etc.):
 - white color - measured value PV (upper line), typical measurement **units** (°C, %, %RH, mA, A, mV, V, m and kPa, Pa, k for AR632.B/652.B/682.B or missing), symbols of outputs status and serial transmissions (1, 2, 3, .)
 - red, bottom line - selectable SP setpoints or 8-segment bargraph for **MV** (control signal in the range of 0÷100%), PV (measurement), mA/V output signal or missing
- optional **RS485** serial interface, **MODBUS-RTU protocol** for reading measurements and parameters configuration
- optional **Ethernet** interface, **MODBUS-TCP** and **MQTT** protocols (for the Internet of Things **IoT/M2M**, cloud and mobile applications), the possibility to exchange measurement and configuration data via the **Internet**
- **USB** interface (micro USB connector, standard equipment, for parameter programming, measurement preview and firmware update)
- automatic/constant compensation of RTD and R line resistance and temperature of thermocouple cold junctions
- programmable input type, range of indications (for analogue inputs), options of control, alarms, display, communication, access, and other configuration parameters
- access to configuration parameters protected by a user's password or without protection
- ways to configure parameters:
 - from the membrane keyboard placed on the front panel of the device
 - via the USB port, RS485 or Ethernet and the ARSOFT-CFG program (for Windows 7/10) or the user's application (using the MODBUS-RTU and TCP communication protocols)
- **free ARSOFT-CFG software** enabling the preview of the measured value and quick configuration of single or ready sets of parameters previously saved on the computer for re-use, e.g. in other controllers of the same type (duplication of configuration)
- panel housing, protection **class IP65** from the front (after using an additional accessory gasket or other seal), IP54 without a gasket, AR662.B - housing for mounting on the TS35 rail (DIN EN 60715), IP40 (IP20 from the connectors side), AR632.B - industrial housing IP65 adapted to work in difficult environmental conditions, wall mounting
- modern technical solutions, intuitive and simple handling, **high accuracy** and long-term stability as well as resistance to interferences
- optional (in the ordering method): control outputs for SSR, analog output 0/2÷10V (instead of 0/4÷20mA) and RS485 interface (for AR602.B excludes mA/V output and BIN input) and Ethernet (RJ45 connector)
- **available accessories** (you can also buy it through the online store apar.sklep.pl):
 - seal for IP65 tightness from the front (applies to panel housings)
 - USB cable (A - micro B) for connection to a computer, length 1.5 m
 - USB to RS485 converter (with galvanic separation)
- **kit contents:**
 - controller (with mounting brackets for panel enclosures) as well as the user manual and warranty card

NOTE:



- before starting work with the controller, read this manual and correctly perform mechanical and electrical installation and configuration of parameters in accordance with chapters 5, 6 and 8 (nomenclature of the parameters was adopted according to the principle: index from [Table 8](#): name in the 7-segment code, e.g. 0: **(mA)**),

- **by default**, the controller is configured to present the temperature from the Pt100 sensor, heating type control (ON-OFF algorithm with hysteresis) for P1/SSR1, P2/SSR2 and P3/SSR3 outputs (alarm 3), description in *chapter 9*.

4. TECHNICAL DATA

Universal input (1 programmable - parameter 0: dnp , 17 types, 18 bit A/C conversion), measuring ranges			
- Pt100 (RTD, 3- or 2-wire)	-200 ÷ 850 °C	- R (TC, PtRh13-Pt) thermocouple	-40 ÷ 1600 °C
- Ni100 (RTD, 3- or 2-wire)	-50 ÷ 170 °C	- T (TC, Cu-CuNi) thermocouple	-25 ÷ 350 °C
- Pt500 (RTD, 3- or 2-wire)	-200 ÷ 620 °C	- E (TC, NiCr-CuNi) thermocouple	-25 ÷ 820 °C
- Pt1000 (RTD, 3- or 2-wire)	-200 ÷ 520 °C	- N (TC, NiCrSi-NiSi) thermocouple	-35 ÷ 1300 °C
- J (TC, Fe-CuNi) thermocouple	-40 ÷ 800 °C	- current (mA, R _{in} = 50 Ω)	0/4 ÷ 20 mA
- K (TC, NiCr-NiAl) thermocouple	-40 ÷ 1200 °C	- voltage (V, R _{in} = 110 kΩ)	0 ÷ 10 V
- thermocouple S (TC, PtRh10-Pt)	-40 ÷ 1600 °C	- voltage (mV, R _{in} > 2 M Ω)	0 ÷ 60 mV
- B (TC, PtRh30PtRh6) thermocouple	300 ÷ 1800 °C	- resistive (R, 3-p or 2-p)	0 ÷ 2500 Ω
Response time for measurements (10÷90%)		0.2 ÷ 3.5 s (programmable), default ~ 0.5 s	
Leads resistance (RTD, Ω)		R _d < 25 Ω (for each line), auto or fixed compensation	
Resistance input current (RTD, Ω)		400 μA (Pt100, Ni100), 200 μA (Pt500, Pt1000, 2500 Ω)	
Processing errors (at an ambient temperature of 25°C):			
- basic	- for RTD, mA, V, mV, Ω	0.1% of the measuring range ± 1 digit	
	- for thermocouples	0.2% of the measuring range ± 1 digit	
- additional for thermocouples		<2 °C (temperature of cold ends)	
- additional caused by ambient temperature changes		<0.004 % of input range /°C	
Resolution of measured temperature		0.1 °C or 1 °C, programmable (with parameter 3: dpt)	
Indications range (resolution for analog inputs)		maximum -1999 ÷ 9999, programmable	
Decimal point position for analog inputs		programmable (3: dop) in the range of 0 ÷ 3, i.e. 0 ÷ 9999	
BIN digital input (contact or voltage <24V)		bi-state, active level: short-circuit or <0.8V	
P/SSR bi-state outputs (3 independent, P3/SSR3 not available for AR602.B)	- relay P (P1, P2, P3), standard for outputs 1 and 2, option for output 3, (current for resistive loads)	AR642.B/652.B/682.B: 8A /250Vac, 1xSPDT, 2xSPST-NO AR602.B/662.B: 5A /250Vac, 2(3 for AR662.B)xSPST-NO AR632.B: 8A /250Vac (1xSPDT), 5A /250Vac (2xSPST-NO)	
	- SSR (SSR1, SSR2, SSR3), option	transistor type NPN OC, 11V, current < 35mA	
Analog output mA/V (1 current or voltage, not galvanically separated from the input)	- current 0/4 ÷ 20 mA, active (standard)	maximum resolution 1.4 μA (14 bit) output load R _o < 1 kΩ	
	- voltage 0/2 ÷ 10 V (option, instead of 0/4 ÷ 20 mA output)	maximum resolution 0.7 mV (14 bit) output load I _o < 3.7 mA (R _o > 2.7kΩ)	
	- errors (% of the initial range)	primary <0.1%, additional 0.004%/°C, at 25°C	
Power supply (Usup, universal, compliant with the standards 24Vac/dc, 48Vac/dc, 110Vac, 230Vac, etc.)		18 ÷ 265 Vac, <3VA (alternating voltage, 50/60Hz) 22 ÷ 350 Vdc, <4W (direct voltage)	
Power supply for object transducers		24Vdc / 30mA	
Communication interfaces (independent, can be used simultaneously)	- USB (micro connector type B, communication with a computer), standard	drivers for Windows 7/8/10 (virtual COM serial port, MODBUS-RTU protocol, Slave)	
	- RS485 (separated), option (in AR602.B excludes mA/V output and BIN input)	MODBUS-RTU protocol, Slave, speed 2.4÷115.2 kb/s, programmable character format (8N1 , 8E1, 8o1, 8N2)	

	- Ethernet (separated), option (in AR602.B as an external module)	RJ45 connector, 10base-T, TCP/IP protocols: MODBUS-TCP (Server), MQTT (client, v. 3.1.1), DHCP (client), ICMP (ping)
Display (LED, 7-segment, 2 lines, 4 digits each, brightness adjustment, symbols for signaling the status of outputs, typical measuring units)	- top, white	digit height: 13 mm (AR632.B/652.B/682.B), 9 mm (AR602.B/642.B/662.B)
	- bottom, red	digit height: 10.5 mm (AR632.B/652.B/682.B), 7 mm (AR602.B/642.B/662.B)
Rated operating conditions		0 ÷ 50 °C, <90 %RH, for AR632.B <100%RH, no condensation inside the device, working environment: air and neutral gases
Protection level	IP65 for AR632.B and for AR602.B/642.B/652.B/682.B from the front with a seal (IP54 without a seal), IP40 for AR662.B, IP20 on the side of connectors (not applicable to AR632.B)	
Weight	~ 200g (AR652.B/642.B), ~280g (AR682.B), ~135g(AR602.B), ~160g (AR662.B), ~320g (AR632.B)	
Electromagnetic Compatibility (EMC)		resistance: according to PN-EN 61000-6-2 standard, emissivity: PN-EN 61000-6-4
Safety requirements according to PN-EN 61010-1 norm	installation category: II	pollution degree: 2
	voltage to ground: 300 V for the supply circuit and relay outputs, 50 V for the remaining input and output circuits and communication interfaces	
	insulation resistance > 20 MΩ	altitude above the sea level <2000 m

5. HOUSING DIMENSIONS AND ASSEMBLY DATA

a) AR602.B, AR642.B, AR652.B

Mounting	panel, handles on the side of the housing
Material	self-extinguishing NORYL 94V-0, polycarbonate
Housing dimensions (W x H x D, without connectors)	AR602.B: 48 x 48 x 79 mm, AR642.B: 48 x 96 x 79 mm, AR652.B: 96 x 48 x 79 mm
Panel window (W x H)	AR602.B: 46 x 46 mm, AR642.B: 46 x 92 mm, AR652.B: 92 x 46 mm
Cable cross-sections (for separable connectors)	2.5 mm ² (power supply and P/SSR outputs), 1.5 mm ² (other)
Optional external Ethernet module for AR602.B (factory-built in for others)	dimensions (W x H x D) 31 x 25 x 56 mm, GOLD-PIN connector, top-mounted after mounting the controller in the panel window (use of a tape or a clamp is recommended)

AR602.B

View from the side of the mounting handle.

Dimensions in mm

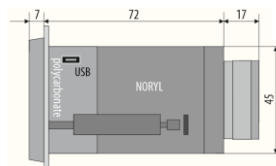

AR642.B
AR652.B

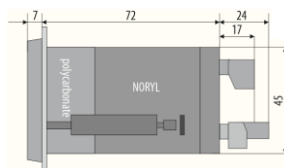

b) AR682.B

Mounting	panel, handles on the side of the housing
Material	self-extinguishing NORYL 94V-0, polycarbonate
Housing dimensions (W x H x D, without connectors)	96 x 96 x 79 mm (W x H x D, without connectors)
Panel window (W x H)	92 x 89 mm (W x H)
Cable cross-sections (for separable connectors)	2.5mm ² (power supply and P/SSR outputs), 1.5mm ² (other)

AR682.B

Side view

Dimensions in mm

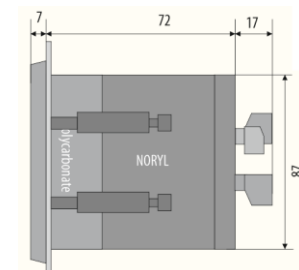

c) AR662.B

Housing type	on the rail, Modulbox 3MH53
Material	PC/ABS self-extinguishing
Housing dimensions	53 x 90 x 62 mm (W x H x D, without connectors)
Mounting	on the TS35 rail (DIN EN 60715)
Cable cross-sections (for separable connectors)	2.5 mm ² (power supply and P/SSR outputs), 1.5mm ² (other)

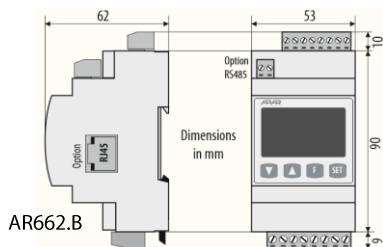

d) AR632.B

Housing type	industrial IP65, Gainta G2104
Material	polycarbonate
Housing dimensions	120 x 80 x 55 mm (W x H x D, without glands)
Mounting	4 holes Φ 4.3 mm, spacing 108x50 mm, accessible after removing the front cover
Cable cross-sections (for separable connectors)	2.5 mm ² (power supply and P/SSR outputs), 1.5mm ² (other)

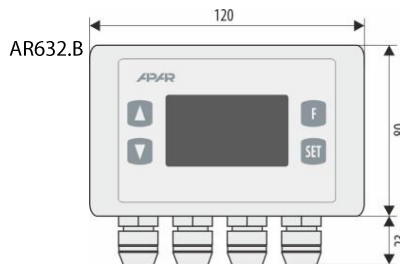

6. DESCRIPTION OF CLAMPING RAILS AND ELECTRICAL CONNECTIONS

Table 7. Numbering and description of clamping rails

Clamps / Connectors	Description
1-2-3	Pt100, Ni100, Pt500, Pt1000 input, resistive, (2- and 3-wire)
2-3	thermocouple input TC (J, K, S, B, R, T, E, N) and voltage input 0÷60mV
3-5	current input 0/4÷20mA
4-5	voltage input 0÷10V
6	+24V output (in relation to 5-GND) of the built-in power supply of object transducers
5-7	BIN binary input (contact or voltage <24 V)
5-8	analog output: current (0/4 ÷ 20mA) or voltage (0/2 ÷ 10V)
9-10 (7-8 for AR602.B), option	RS485 serial interface (MODBUS-RTU protocol), in AR602.B RS485 module excludes analogue mA/V output and binary input BIN (according to the order code), <i>chap.11</i>
12-13	power supply input (universal)
14-15-16	P1 or SSR1 relay output (14-15), for AR602.B P2 or SSR2 output: 14-15
17-18	P2 or SSR2 relay output, for AR602.B P1 or SSR1 output
19-20	P3 or SSR3 relay output (except AR602. B)
USB (micro type B)	USB serial interface for cooperation with a computer, <i>chapter 11</i>
RJ45 (option)	Ethernet serial interface (MODBUS-TCP, MQTT protocols, etc.), <i>chapter 11</i>

a.1) Connectors for AR642.B, AR652.B, AR682.B

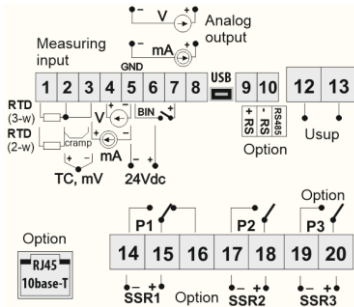

a.2) Connectors for AR602.B

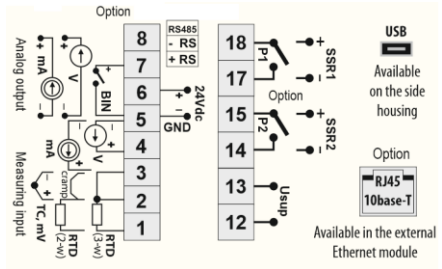

a.3) Connectors for AR632.B (connectors are accessible after removing the front cover and display board, except for USB)

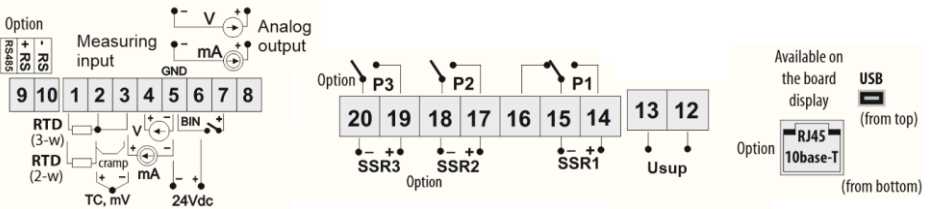

NOTE:

To perform the wiring assembly for **AR632.B** follow the instructions below:

- unscrew 4 screws in the front plate and remove it from the device
- the device can be screwed to the base with 4 screws in the mounting holes
- unscrew 1 screw on the display board and carefully slide the board out of the mounting sockets
- connectors for signal cables, power supply and relay outputs are available
- lead the electric wires into the housing through cable glands (and tighten the optional RJ45 pin)
- after assembly, assemble the device in the reverse order to that described above
- IP65 tightness requires precise tightening of the gland nuts and the housing cover
- to avoid possible mechanical and electrostatic damage, be especially careful caution when handling the display board.

a.4) Connectors for AR662.B (description of clamps in Table 7)

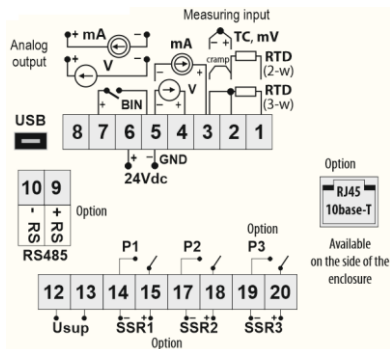

b) Galvanic separation of circuits

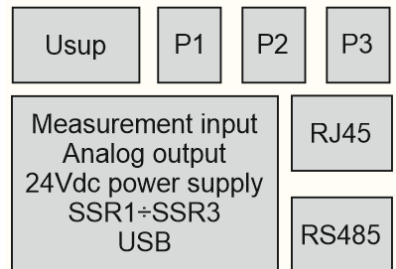

c) Connection of 2- and 3-wire converter

(I_o - current, U_o - output voltage)

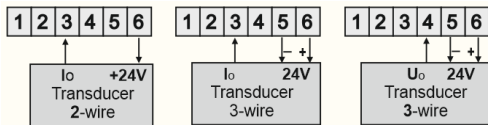

d) Connection of SSR type relay

(to the controller control output)

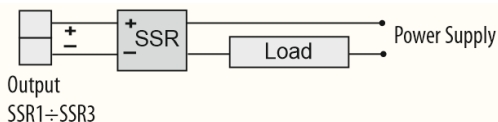

NOTE:

For inductive loads, consider the use of blowout that will reduce the burnout of the relay pins



7. DESCRIPTION OF KEYS AND LED DISPLAY FUNCTIONS

a) keys functions in the measurement display mode

Key	Description [and the method of marking in the content of the manual]
+	[DOWN] and [UP] (simultaneously): 1. entering the parameter configuration menu (after holding time longer than 1.5 seconds), proceed as described in <i>chapter 8</i> , point 1, 2. resetting errors (confirmed by the message Err), <i>chapter 10</i>
or	quick change of the displayed setpoint of the output (SEE , SEE or WSEE , the selection of the value for the lower line is set with the parameter 73: U₁ , <i>chapter 8</i>), step x1 (or x10 , description <i>in point c</i>)
SET	[SET]: 1. entering the quick access menu (after a short press, <i>chapter 9.1</i>), 2. activation of the additional function selected with parameter 66: F_{unF} (pressing > 1.5s, <i>chap. 7.1 and 8</i>)
F	[F] (not available in AR602.B): activation of the function selected with parameter 64: F_{unF} (pressing longer than 1.5 seconds, description in <i>chapters 7.1 and 8</i>)
[UP]+[DOWN]+[SET] (simultaneously) or [F], [SET] and BIN input, when no function (64: F_{unF}/S/B = nonE)	Device status: upper line of the display - firmware version , lower - Ethernet interface status (EE - no, EE - available, but disabled with parameter 77: E_{En} or not connected to the LAN network, EE - connected to the LAN network, EE or EE - MODBUS-TCP protocol port open, EE or EE - connection with the MQTT broker established) and RS485 (EE - no, EE - available), analog output type (mA unit - current, V -voltage)

b) keys functions in the parameter configuration menu and in the quick access menu (*chapters 8 and 9.1*)

Key	Description [and the method of marking in the content of the manual]
SET	[SET]: 1. selection of the displayed item in the configuration menu (entering a lower level), 2. editing the current parameter (value blinking on the lower display), 3. approval and saving of the edited parameter value
or	[UP] or [DOWN]: 1. going to the next or previous parameter, 2. change of the value of the edited parameter with a step of changes x1 (or x10 , description <i>in point c</i>)

 +  or 	<p>[UP] and [DOWN] (simultaneously) or [F]:</p> <ol style="list-style-type: none"> 1. returning to the previous menu (one level higher), 2. cancelling changes of the edited value (flashing stops), 3. returning to the measurement display mode (holding time > 0.5s, except for [F])
---	---

c) additional functions of keys during the change (edition) of setpoints and other configuration parameters

Keys	Description
[SET] + [UP] or [SET] + [DOWN]	changing the value of the edited parameter (with a step of changes x10 , keys pressed simultaneously)
[SET] + [UP] + [DOWN]	restoring the factory value of the edited parameter (according to <i>Table 8, chapter 8</i>)

In addition, the speed of changing the edited value depends on the time the keys are held (the longer the faster).

d) functions of the LED display elements

AR602.B
AR642.B
AR662.B

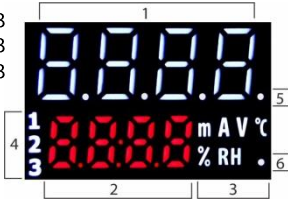

AR632.B
AR652.B
AR682.B

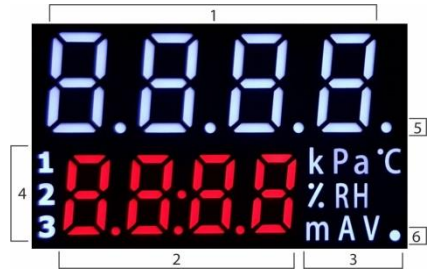

Fig.7. View of all segments of the display

Element	Description [and the method of marking in the content of the manual]
1, 2	upper and lower line for presenting (in 7-segment code) PV measured values and SP setpoints or bargraph values (8-segment, <i>chapter 8</i> , parameter 73: dBm) and other messages and errors (<i>chapter 10</i>)
3	units for displayed values (for measurements set with parameter 72: Un , description in <i>chapter 8</i>)
4	[1] [2] [3] - P1/SSR1, P2/SSR2, P3/SSR3 outputs activation signaling (LED alarm for AR602.B)
5	[T]: 1. analysis of the object for PID tuning signaling (auto-tuning) in the Auto mode (smart logic, <i>chapter 9.4</i>), 2. time measurement signaling in the software algorithm (process controller with timer, <i>chapter 9.6</i>)
6	[Tx/Rx] - icon of the presence of USB, RS485 or Ethernet transmission and saving parameters in the controller's memory

7.1. FUNCTION KEYS AND BINARY INPUT

Independent function keys **[F]** (not available in the AR602.B) and **[SET]** as well as the **BIN** binary input are used to quickly run the programmed functions (with parameters 64: **FunF**, 66: **FunS** and 65: **Funb**, described in *chapter 8*). The **BIN** digital input cooperates with a bistable signal, i.e. the supplied signal (voltage or switch) must be permanent (on/off type, active level: short-circuit or < 0.8V). Moreover, **BIN** has priority higher than the **[F]** and **[SET]** keys. Activating or stopping the function is signaled by appropriate messages on the lower display (described in *Table 8* and *chapter 10*). The action for **[F]** and **[SET]** is performed only in the mode with measurement display (after holding time > 1.5 sec), for **BIN** - always (in every operating state).

8. SETTING CONFIGURATION PARAMETERS

All controller configuration parameters are contained in non-volatile (permanent) internal memory. When switching on the appliance for the first time, the display may show an error signal related to the lack of

sensor or attached one other than factory programmed one. In such case, connect the appropriate sensor or analog signal, or perform the programming of the configuration.

There are two ways to configure the parameters (manual and remote, do not use simultaneously):

1. Manually, from the membrane keyboard placed on the front panel of the device:

- from the display mode of input measurements in the configuration menu (simultaneously press the [UP] and [DOWN] keys for longer than 1.5 sec.) If parameter 69:PPPrd=on (password protection is enabled) the message Conf will appear on display, followed by 0000 with the first digit flashing, with the [UP] or [DOWN] key enter the access password (default parameter 70:PASS=1111), to move to the next positions and confirm the code use the [SET] key, to cancel the changes use the [UP]+[DOWN] or [F] keys,
- after entering the main configuration menu (with the message Conf) the upper line shows the mnemonic name of the submenu (parameter groups: inf <-> out <-> out <-> etc.), the bottom line is dimmed or displays none (no module, depending on the hardware version of the controller),
- use the [UP] or [DOWN] keys to select the appropriate submenu, and then press [SET] to confirm the selection (the name of the parameter is now visible on the upper line and the value on the lower line of the display),
- the [UP] key takes you to the next parameter, [DOWN] to the previous one (eg: inf <-> err <-> out <-> etc., only parameters compatible with the hardware version are available, a summary list in *Table 8*),
- to change the value of the current parameter, briefly press the [SET] key (flashing in edit mode),
- use the combination of [UP], [DOWN] and [SET] keys to change the value of the edited parameter (with a step of changes x1 or x10 or load the default value of a parameter, description of the function in *chapter 7*, points b and c),
- confirm the changed value of the parameter with the [SET] key or cancel it with the [F] or [UP]+[DOWN] keys,
- pressing [UP]+[DOWN] or [F] again causes the return to the main configuration menu (one level up),
- exit from configuration: long press of [UP]+[DOWN] keys or automatically after approx. 2 minutes of inactivity

2. Remotely through the USB port, RS485 or Ethernet and the ARSOFT-CFG computer program (*chapter 11*):

- connect the controller to the computer port, run and configure the ARSOFT-CFG application,
- after establishing the connection, the program displays the current measurement, the icon [Tx/Rx] signals transmission (*chapter 7, point d*)
- setting and viewing device parameters are available in the parameter configuration window
- new parameter values must be confirmed with the **Approve changes** key
- the current configuration can be saved to a file or set with values read from the file

NOTICE: 







- before disconnecting the device from the computer, use **the Disconnect the device** (ARSOFT-CFG) key
- in the absence of a response:
 - check the settings in **Edit of configuration** (*Connection type, COM Port, MODBUS address of the device, etc.*)
 - for USB, check whether the drivers for the serial port in the computer have been correctly installed (*see section 11*)
 - disconnect for a few seconds and reconnect the regulator or the RS485 converter to the USB port of the computer
- restart the ARSOFT-CFG and/or the computer

If there is a discrepancy between the indications and the actual value of the input signal, it is possible to tune the zero and sensitivity to a given sensor: parameters 7:CAL0 (zero) and 8:CAL1 (sensitivity).

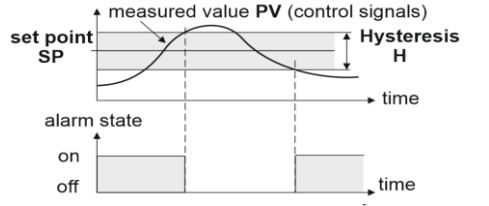





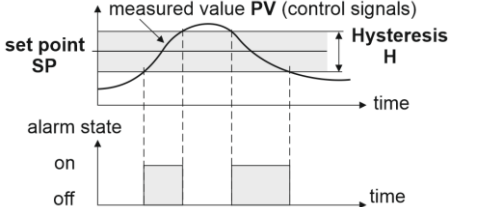



In order to restore the factory settings, press the [UP] and [DOWN] keys during start until the password entry menu appears (Conf), and then enter the code 8112. Alternatively, you can use the file with the default configuration in the ARSOFT-CFG program.

Table 8. List of configuration parameters

Parameter (index: name)	Value and range of variability of the parameter (value: name) and description		Default
I. MEASURING INPUT CONFIGURATION, <i>INCD</i> submenu			
0: <i>INP</i> type of measurement input	0: <i>PT100</i> Pt100 sensor (RTD, -200÷850°C)	1: <i>NI100</i> Ni100 sensor (RTD, -50÷170°C)	<i>PT</i>
	2: <i>PT500</i> Pt500 sensor (RTD, -200÷620°C)	3: <i>PT1000</i> Pt1000 sensor (RTD, -200÷520°C)	
	4: <i>TCJ</i> thermocouple type J (-40 ÷ 800 °C)	5: <i>TCK</i> thermocouple type K (-40÷1200°C)	
	6: <i>TC5</i> thermocouple type S (-40 ÷ 1600 °C)	7: <i>TCB</i> thermocouple type B (300÷1800°C)	
	8: <i>TCR</i> thermocouple type R (-40÷1600°C)	9: <i>TCB</i> thermocouple type T (-25÷350°C)	
	10: <i>TC5</i> thermocouple type E (-25÷820°C)	11: <i>TCN</i> thermocouple type N (-35÷1300°C)	
	12/13: <i>4-20mA</i> 4÷20 mA / 0÷20 mA current signals		
	14/15: <i>0-10V</i> / <i>0-60mV</i> 0÷10 V / 0÷60 mV voltage signals		
	16: <i>RES</i> resistance signal 0÷2500 Ω		
1: <i>LR</i> line resistance (1)	<i>000</i> ÷ <i>5000</i> Ω	total line resistance for 2-wire RTDs and 2500 Ω sensors	<i>000</i> Ω
2: <i>CTC</i> temperature of thermocouple cold ends	0: <i>Auto</i> <i>0.1</i> ÷ <i>500</i> °C	automatic or constant temperature compensation of the reference junction of thermocouples, <i>Auto</i> = 0.0 °C	<i>Auto</i>
3: <i>dot</i> dot position/resolution	<i>0</i> / <i>1</i> <i>0</i> / <i>0.1</i>	no dot / <i>0.1</i> (2) or resolution 1/0.1°C for temperature	<i>1</i> (0.1°C)
4: <i>SP</i> lower limit for SP or the bottom of the indication range	<i>4999</i> ÷ <i>1800</i> <i>4999</i> ÷ <i>9999</i> (2)	lower setting limit for setpoints SP (11: <i>555.1</i> ÷ <i>555.3</i>) beginning of the scale for the 0/4mA, 0V, 0Ω input and the PV bargraph	<i>4999</i> °C
5: <i>SP</i> upper limit for SP or the top of the indication range	<i>4999</i> ÷ <i>1800</i> <i>4999</i> ÷ <i>9999</i> (2)	upper setting limit for setpoints SP (11: <i>555.1</i> ÷ <i>555.3</i>) end of scale for 20mA, 10V, 60mV, 2.5kΩ inputs and PV bargraph	<i>8500</i> °C
6: <i>FIL</i> filtration (3)	<i>1</i> ÷ <i>20</i>	digital filtering degree (response time)	<i>0</i> (~0.5s)
7: <i>zero</i> zero calibration	zero offset for measurements: <i>-1000</i> ÷ <i>1000</i> °C or <i>-1000</i> ÷ <i>1000</i> units (2)		<i>00</i> °C
8: <i>gain</i> gain	<i>850</i> ÷ <i>1150</i> %	slope calibration (sensitivity) for measurements	<i>1000</i> %
II. CONFIGURATION OF OUTPUTS 1÷3 (P/SSR), submenu <i>OUT1</i> ÷ <i>OUT3</i>, in 3 groups <i>OUT1/2/3</i> there are the same sets of parameters with different indices and numbering in the names (and possibly the range of variability), description <i>chapter 9</i>			
9: <i>ALG</i> control algorithm	0: <i>OFF</i> output permanently switched off	1: <i>ON</i> / OFF with hysteresis	<i>ON</i>
16: <i>PID</i> for output 2 (<i>OUT2</i>)	2/3/4: <i>PID</i> / <i>0</i> / <i>1</i>	PID with parameter set 1/2/3 (<i>chapter 9.3</i>)	<i>PID</i>
23: <i>OUT</i> for output 3 (<i>OUT3</i>)	5/6: <i>Pr</i> / <i>Gr</i> / <i>A</i> 	software - main/auxiliary output (<i>chapter 9.6</i>)	
Note (for 8/9 values): if [F] / [SET] or BIN with the	7: <i>hRnd</i> M (manual)	manual (with the setpoint set with parameter 67: <i>HSE</i> and pulse period of the P/SSR output, 14: <i>PER</i> / <i>2</i> / <i>0</i>)	
	8/9: <i>STB</i> / <i>n</i>	safety thermostat STB (alarm with memory, LATCH), emergency state open/closed (reset [F] , [SET] , BIN , chap. 7.1)	

<p>start/stop function of the outputs operation was used to reset the STB (LATCH) alarm, a start is always needed to restart the STB and regulation</p>	<p>10/11: on/off</p>	<p>direct/inversed copy of the state of output 1 (only for parameters 16/23: setpoint, outputs 2/3, e.g. for the implementation of a switching output of DPDT type)</p>	
<p>10: fund type of regulation/alarm</p> <p>17: fund for output 2 (out2)</p> <p>24: fund for output 3 (out3)</p> <p>1. concerns the control algorithms: ON-OFF with hysteresis, PID, software (main output), STB (LATCH) and step adjustment (servo)</p> <p>2. for PID, software (main output) and servo algorithms, only heating/inversed and cooling/direct characteristics apply</p>	<p>0: indH heating / inversed</p> <p> (activated below SP)</p>	 <p>Fig.8.1. Characteristics of the heating type (for ON-OFF)</p>	<p>indH</p>
<p>2: indB in band alarm</p>	<p> (activated in band)</p>	 <p>Fig.8.3. Characteristics of the in band alarm (ON-OFF)</p>	
<p>3: outB out of band alarm</p>	<p> (disabled in band)</p>	 <p>Fig.8.4. Out of band alarm characteristics (ON-OFF)</p>	
<p>3. Values 4÷7 (i.e. in relation to 11: setpoint) are available only for parameters fund2/3 (outputs 2/3)</p>	<p>4: inB in band alarm \pm setpoint/3 around the setpoint 11: setpoint</p> <p> (activated in band)</p>	 <p>Fig.8.5. Characteristic in band in relation to setpoint</p>	

<p>5: SEt1 out of band alarm \pm SEt2/3 around setpoint 11: SEt1</p> <p>\pm (disabled in band)</p>		<p>Fig.8.6. Characteristic <i>out of band</i> in relation to SEt1</p>	
<p>6: SEof disabled below $SP = SEt1 + SEt2/3$</p> <p>\uparrow (activated above SP)</p>		<p>Fig.8.7. Deviation in relation to SEt1 (for SEt2/3 > 0)</p>	
<p>7: SEon activated below $SP = SEt1 + SEt2/3$</p> <p>\downarrow (activated below SP)</p>		<p>Fig.8.8. Deviation in relation to SEt1 (for SEt2/3 < 0)</p>	
<p>11/18/25: SEt1/2/3 SP setpoint for control/alarm</p>	<p>changes in the range set with parameters 4: urLo and 5: urHi</p>	<p>1000 °C</p>	
<p>12/19/26: H1/2/3 hysteresis H or PID tuning zone</p>	<p>hysteresis or PID tuning deadband in mode Rule0 (smart logic, <i>chapter 9.4</i>), 00 \div 9999 C or 0 \div 9999 units (2)</p>	<p>10 °C</p>	
<p>13/20/27: oPF1/2/3 power limitation (available power)</p>	<p>0 \div 100 %, maximum level of the control/power signal (also for the related analogue output mA/V with parameter 31: FunA), step by 1% (4)</p>	<p>100 %</p>	
<p>14/21/28: PEr1/2/3 pulse period of the Tc output</p>	<p>1 \div 999 s, applies to power limitation and manual mode, PID and servo algorithm, for P/SSR outputs (pulsing with 0 \div 100% fill factor)</p>	<p>1 sec.</p>	
<p>15/22/29: FEo1/2/3 output emergency state</p>	<p>for missing/damaged sensor/signal/input or outside the measuring range: 0: noCh = no change, 1: oFF = disabled, 2: on = enabled, 3: hAnd = manual mode with a set output signal level (parameter 67: WSEt)</p>	<p>oFF</p>	
<p>III. CONFIGURATION OF THE ANALOG OUTPUT mA/V, submenu outA, detailed description in <i>chapter 9.2</i></p>			
<p>30: REY analog output type/standard</p>	<p>depending on the order code (hardware version): for current output 0: 0-20 or 1: 4-20 mA, for voltage output 0: 0-10 or 1: 2-10 V</p>	<p>0-20 mA (0-10 V)</p>	
<p>31: FunA analog output function</p>	<p>0: oFF = permanently off (0mA or 0V), 1: FEtP = PV measurement retransmission, 2/3/4: FEt1/2/3 = SP setpoint retransmission (i.e. 11/18/25: SEt1/2/3), 5/6/7: oOn1/2/3 = control output related to output parameters 1/2/3</p>	<p>oFF</p>	
<p>32: RELo lower indication for retransmission</p>	<p>beginning of the output scale - for the value of the output signal 0/4mA or 0/2V (the parameter is active only for retransmission, when 31: FunA = FEtP or FEt1/2/3)</p>	<p>00 °C</p>	
<p>33: REHi upper indication for retransmission</p>	<p>end of the output scale - for the output signal value of 20mA or 10V (this parameter is active only for retransmission when 31: FunA = FEtP or FEt1/2/3)</p>	<p>1000 °C</p>	
<p>34: EBot bottom adjustment</p>	<p>000 \div 999 mA/V</p>	<p>calibration of the variability range of the output signal, with a step of 000 mA/V for 0/4mA or 0/2V</p>	

35: ctOP upper correction	-400 ÷ 0.50 mA/V	changes oF005 mA/V	for 20mA or 10V	
IV. PID ALGORITHM CONFIGURATION (1÷3), submenu Pnd 1 ÷ Pnd 3 , in the 3 groups Pnd 1/2/3 there are the same parameter sets with different indices and numbering in the names, description in <i>chapters 9.3÷9.5</i> 				
36/40/44: Fun 1/2/3 type of PID tuning (autotuning)	0: oFF = disabled, 1: Auto = smart logic, 2: S EEP = step response method (fast), 3: oSet = oscillation method (longer), <i>chapter 9.4</i>			oFF
37/41/45: Pb 1/2/3 Pb proportional band	0.1 1800 or 1 ÷ 9999 units (2)			10 °C
38/42/46: ti 1/2/3 integral time Ti	0 9500 s, PID algorithm integral action time, 0 turns off the integral element			0 sec.
39/43/47: td 1/2/3 derivative time Td	0 ÷ 999 s, PID derivative action time, 0 turns off the derivative element			0 sec.
V. CONFIGURATION OF THE PROCESS CONTROLLER (programmable operating characteristic, ramping), submenu  PrOG , description - <i>chapter 9.6</i>				
48/53/58: YP 1/2/3 stage type 1/2/3	0: GrE  	stage consisting of 2 segments: reaching the setpoint 11: SEt 1/2/3 with the slope defined by parameter 49: GrA 1/2/3 (ramping) and countdown (50: tR 1/2/3) after reaching it		GrE
	1: tAE 	countdown of time after reaching the setpoint SEt 1/2/3 (0/2)		
	2: tOb 	countdown of time for the entire stage (regardless of the setpoint)		
	3: EndL 	continuous - no time limit		
4: StoP 	end - the last stage of the program, available only for stage 2/3			
49/54/59: GrA 1/2/3 slope of the segment of the stage 1/2/3	pace of changes (gradient) for the 1st segment of the type stage GrE , ramping,  -300 ÷ 300 C/min or 300 ÷ 300 units/min (2)			10 °C/min
50/55/60: tR 1/2/3 time for stage 1/2/3	0 ÷ 1440 min, duration of the segment for the stage with countdown 			60 min
51/56/61: PSE 1/2/3 control algorithm for step 1/2/3	1: oNoF = ON-OFF with hysteresis, 2/3/4: Pnd 1/2/3 = PID with parameter set 1/2/3 (<i>chap. 9.3</i> , not recommended for the stage GrE - gradient may disturb PID operation)			oNoF
52/57/62: ASt 1/2/3 state of the auxiliary output during stage 1/2/3, 63: ASSt after the completion of stage 3	1: oFF = disabled, 2: oN = enabled, 3: hRNd = manual mode with a set output signal level (parameter 67: WSEt), selection of the auxiliary output (1/2/3) is defined by the parameter 9/16/23: ctY 1/2/3 = PrGR			oFF
VI. KEYS, ACCESS OPTIONS AND OTHER CONFIGURATION PARAMETERS , submenu oLhE				
64: FunA function of [F] key 65: FunB function of the binary input BIN 66: FunS additional function of the [SET] key 1. detailed description in <i>chapter 7.1</i> 2. values 3÷8 (quick manual mode) interrupts and resets the tuning and	0: noNE	inactive - device status (description, <i>chapter 7, point a</i>)		noNE
	1: SEt3	step change of the setpoint <u>with the set</u> of parameters for outputs 1 and 3 (day = 11: SEt 1 / night = 25: SEt 3), both outputs work <u>the same</u> (copy)		
	2: blOc	keyboard lock, messages blOa (stop)/ blOn (start, default)		
	3: hd 1A 5: hd 2A 7: hd 3A	unconditional manual M mode for the output 1/2/3 with the output signal level (MV) set by parameter 67: WSEt , messages hnd 1/2/3	start (<u>unchanged</u>) with an initial value for 67: WSEt taken from the current automatic control mode	
	4: hd 1B 6: hd 2B 8: hd 3B	parameter 67: WSEt , messages hnd 1/2/3 (start)/ hoF 1/2/3 (stop)	start (<u>step</u>) with the preset value of parameter 67: WSEt	
	9: ctLR	deleting errors and alarm memory (LATCH) of the STB safety controller with the message ctLEn or noNE (when there are no errors and alarms)		

the PID and software algorithm for the given output (1/2/3)	10: SPSE	start/stop of outputs 1/2/3	when power is on, default <u>stop</u>	
	11: SESP	with function 9: CLER , messages SEAR/SEOR/CLER	default <u>start</u> (only for [F] and [SET])	
67: SEEA control signal setpoint (MV) for outputs in manual mode	0 ÷ 100 % M	applies to all outputs (1, 2, 3 and analog one), 100 % means the maximum available output power (set with parameters 13/20/27: OPF1/2/3), step by 1% (4)		500 %
68: SEEA Lock of quick setpoint changes SEEA/2/3 , (<i>chapter 9.1</i>)	0: OFF = no locks, 1/2/3: SEEA/2/3 = lock of one of the settings (SEEA/2/3), 4: SEEA = simultaneous for SEEA and SEEA , 5: SEEA = for SEEA and SEEA , 6: SEEA = for SEEA and SEEA , 7: SEEA = for all settings (SEEA , SEEA and SEEA)			OFF
69: PPPA protection of configuration with an access password	0: OFF = entering the manual and remote configuration menu is <u>not</u> protected with a password, 1: on = manual and remote configuration (<u>only</u> for ARSOFT-CFG) is protected with password			on
70: PPSS access password	0000 ÷ 9999	password for entering the configuration menu and for the MQTT (<i>chapter 11.1</i>)		1111
VII. DISPLAY OPTIONS , submenu DISP				
71: BRID brightness	10 ÷ 100 %	display brightness, step by 10%		100 %
72: UNID display unit of measurement	0: none = none, 1: m = m, 2: mA = mA, 3: A = A, 4: mV = mV, 5: V = V, 6: °C = °C, 7: PRH = %RH, 8: PERC = %, <u>only for AR632.B/652.B/682.B</u> : 9: k = k, 10: Pa = Pa, 11: PPA = kPa			°C
73: UNBD displayed value for the bottom line	0: OFF = none, 1/2/3: CON1/2/3 = setpoint for output 1/2/3, 4/5/6: BAR1/2/3 = MV1/2/3 bargraph (output 1/2/3 MV control signal in the range 0÷100%), 7: BARA = bargraph for mA/V output, 8: BARP = PV bargraph (measurement in the range: IRL0 ÷ IRH4)			CON1
VIII. COMMUNICATION OPTIONS FOR RS485 AND ETHERNET , submenu ERRA , description in <i>chapters 11 ÷ 11.5</i>				
74: RYBA speed for RS485	bitrate kbit/s, 0: 24 , 1: 48 , 2: 96 , 3: 192 , 4: 384 , 5: 576 , 6: 1152			192 kbit / s
75: RYCA RS485 character format	selection of parity and stop bits, 0: On (none), 1: BE (even), 2: BO (odd), 3: On			On
76: ADDR MODBUS-RTU address	1 ÷ 247	device address for RS485 and suffix (suffix) for the name, (5)		1
77: ETHER Ethernet interface operating mode (MAC hardware <u>address</u> available from ARSOFT-CFG and MODBUS-RTU/TCP)	0: OFF	Ethernet always <u>off</u> (<u>recommended when not in use</u>)		OFF
	1: Auto	DHCP client <u>enabled</u> , network parameters (from 78: ETP3 to 89: ETAR), i.e. device IP address, mask and gateway) are set <u>automatically</u>		
	2: SEAR	DHCP client <u>disabled</u> , network parameters are set <u>manually</u>		
78÷81: ETP3/2/1/0 IP address	0 ÷ 255	device's IPv4 address in the local network (Ethernet), 4 consecutive octets		192.168.0.200
82÷85: ESD3/2/1/0 IP mask	0 ÷ 255	mask of the IPv4 address in the local network (Ethernet), 4 consecutive octets		255.255.255.0
86÷89: EGR3/2/1/0 IP gateway	0 ÷ 255	router's IPv4 address in the local network (Ethernet), 4 consecutive octets		192.168.0.1
90: ETCP MODBUS-TCP port	1 ÷ 9999 9	TCP port number for the MODBUS-TCP protocol (also for ARSOFT-CFG)		502
91: MQTA operating mode and type of published MQTT messages (Ethernet) (detailed description of MQTT communication, <i>chapter 11.1</i>)	0: OFF	MQTT protocol <u>disabled</u> (<u>recommended when not used</u>)		OFF
	1: PV	MQTT protocol enabled, <u>only measurement (PV)</u> in the publication, e.g. "4.5"		
	2: PVUN	MQTT protocol enabled, <u>measurement (PV) and unit</u> in the publication		
	3: NAMEPV	MQTT enabled, <u>device name, PV and unit</u> in text, (5)		

	4: F_{uL}L	publication of full operating status (PV, MV, mA/V output status, BIN, etc.)	
92 ÷ 95: A₉₅ ÷ B MQTT address	0 ÷ 255	IPv4 address of the MQTT broker (Ethernet), 4 consecutive octets	192.168.0.10
96: A₉₆ MQTT broker port	1 ÷ 9999	MQTT broker TCP port number	1883
97: A₉₇ MQTT publication period	1 ÷ 9999 s	interval of sending messages to the MQTT broker (Ethernet)	10 sec.
98: A₉₈ MQTT subject level	1 ÷ 9999	numeric suffix for MQTT publication subject name (APAR/ A₉₈)	APAR/ 1

- Notes:** (1) - for 3-wire sensors the parameter **A₉₈** must be equal to **0000** Ω (automatic compensation),
(2) - applies to analog inputs (mA, V, mV, Ω),
(3) - for **F_{uL}L** = **1** the response time is 0.25 second, for **F_{uL}L** = **20** at least 3s. Higher degree of filtration stands for the more "smoothed" measured value and the longer response time recommended for measurements of turbulent nature (e.g. boiler water temperature),
(4) - for binary outputs (P/SSR) large rounding can occur, 1% is possible only for the pulse period (parameters 14/21/28: **P_{ER}1/2/3**) greater than 20s, for 4s it is 5%, for 2s 10%, for 1s up to 20%.
 **Control signal **MV** = 100% means the maximum available output power (limited by 13/20/27: **oPF 1/2/3**),**
(5) - the device name is created according to the template: AR6x2. **A_{addr}** (e.g. "AR6x2_1" for 76: **A_{addr}** = **1**). It is used in the content of the published MQTT message (*chapter 11.1*) and by the DHCP client (when 77: **oLn0** = **A_{uL}o**).

9. OUTPUT OPERATION CONFIGURATION

Programmable architecture of the controller allows its use in many fields and applications. Before starting the device operation, set the parameters to individual needs (such as control algorithms 9/16/23: **oCY1/2/3**, types of control/alarms 10/17/24: **F_{uN}1/2/3**), setpoints 11/18/25: **SE1/2/3** and other described in *Table 8, chapter 8*). If there is a need to start the control for a specific time (timer function), you should additionally use the possibilities offered by the program control (*chapter 9.6*).

A detailed description of configuration of the operation of outputs is included in *chapters 9.1÷9.7*.

The default (factory) configuration is as follows: outputs 1, 2 and 3 (alarm for AR602.B) in the heating control mode (ON-OFF algorithm with hysteresis), the analog output is disabled (*Table 8*, factory settings column).

9.1. CHANGE OF SETPOINTS FOR OUTPUTS. QUICK ACCESS MENU.

In the measurement display mode (PV), the bottom line shows the setpoint SP for the selected output or the bargraph or it can be blanked (selection with parameter 73: **o_{bl}**, *chapter 8*). The easiest way to change the SP setpoint **visible in this mode** is to use the combination of the **[DOWN]**, **[UP]** and **[SET]** keys described in *chapter 7* (with a step of x1 or x10). All SP setpoints (i.e. parameters 11/18/25: **SE1/2/3** and optionally 67: **MS1** - when the output is in manual mode) are available in the quick access menu and in the parameter configuration mode (ways of changes are described in *chapter 8*). The **quick access menu** is entered by pressing the **[SET]** key, without the need to enter the password. Optionally, to disable fast SP changes (with the message **oL_o**), you can use parameter 68: **MS1** (*Table 8*). Exit from the menu takes place after long pressing the **[DOWN]** + **[UP]** keys or automatically after 7 seconds of inactivity.

9.2. ANALOG OUTPUT (mA/V)

The standard of the output signal is set by parameter 30: **A_{LYP}** (*chapter 8, Table 8, point III*). The analog output can be programmed (with parameter 31: **F_{uN}A**) to work in one of the following modes: retransmission of the PV measurement or setpoint SP and as a control output associated with the parameters of the selected output 1, 2 or 3. In the measurement or setpoint retransmission mode, the output signal is proportional to the PV or SP signal within the range set with parameters 32: **A_{RL}** and 33: **A_{RH}** (e.g. 0mA for the measured value 0°C when **A_{RL}** = 0 C, 20mA for 100 C when **A_{RH}** = 100 C and respectively 10mA for the half of the range, i.e. 50°C). In other words,

the output operating in the retransmission mode enables the conversion of the input signal to the output signal (in the range $R-L_0 \div R-H_1$). In the control output mode, the control parameters and functions are the same as for the related output 1/2/3, but the variability range of the analog signal is continuous (0 ÷ 100%) only for the PID algorithm (chapter 9.3) and manual operation, for the control of ON-OFF type with hysteresis, the output has extreme values (bottom or upper value, e.g. 0mA = 0% = OFF or 20mA = 100% = ON) without intermediate values, which can be used e.g. to activate the SSR relay.

The values of the output signal (mA/V) can be presented in the form of a bargraph on the bottom line of the display (parameter 73: $B.LB_0 = B.R.R$) or read from the level of MODBUS-RTU/TCP and MQTT protocols, chapter 11. Moreover, it is possible to correct (calibrate) the range of changes of the output signal (parameters 34: $C.B_0$ and 35: $C.L.P$).

9.3. PID CONTROL



The PID algorithm makes it possible to obtain smaller temperature control errors than the ON-OFF method with hysteresis. However, this algorithm requires selection of parameters characteristic for a specific regulation object (eg a furnace). In order to simplify the handling, the controller is equipped with advanced functions of PID parameter selection, described in chapter 9.4. In addition, it is always possible to manually adjust the settings (chapter 9.5).

The PID control for a given control output is active when one of the three sets of PID parameters is selected (with the parameter $E.t.t./2/3$, description in chapter 8, Table 8, point II, or with the parameter $P.S.E./2/3$, point V), i.e. $P.t.d./2/3$.

The position of the proportional band Pb ($P.b./2/3$, Table 8, point IV) in relation to the setpoint SP ($S.E.t./2/3$) is shown in Figures 9.3 a) and b). The parameters $E.t.i./2/3$ and $E.t.d./2/3$ are responsible for the influence of the integral and derivative element of the PID control.

The parameter $P.F.r./2/3$ sets the pulse period Tc for the P/SSR output (it is also the time of its status update), while $P.P.F./2/3$ the available power used for selecting PID parameters. If the PID algorithm is implemented by the 0/4 ÷ 20mA or 0/2 ÷ 10V analog output, the Tc period is irrelevant. The mA/V output signal is then updated every 1 s and it can adopt intermediate values from the entire range of output variability (0÷100%).

The principle of operation of the P-type control (proportional control) for the P/SSR output is shown in figures d), e) for the analog output, figure c).

Fig. 9.3. Principle of PID regulation operation:

- a) position of the Pb proportional band in relation to the setpoint SP for the heating type control ($F.un.t./2/3 = i.ndH$)
- b) position of the proportional band Pb in relation to the setpoint SP for the cooling type control ($F.un.t./2/3 = d.irC$)
- c) the status of the analog output 0/4÷20 mA or 0/2÷10V
- d) duty factor k for a bi-state P/SSR output
- e) the status of the output for the measured value PV within the Pb range

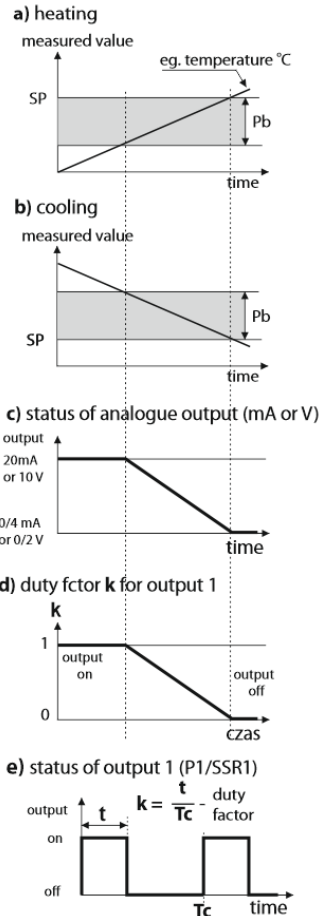

In order to use the PID parameter selection function for a given control output (1/2/3), first select the PID parameters set (using the method described in [chapter 9.3](#)) to which the calculated data will be saved, and then set the type of auto-tuning (with the parameter [Eun1/2/3](#) description in [chapter 8, Table 8, point IV](#)). The auto-tuning is activated at the start of the control (automatically after switching the supply on or manually using the [F], [SET] function keys or the BIN binary input programmed as the start/stop of outputs operation, [chapter 7.1](#)). Autotuning is performed independently for each of the outputs with the maximum available power (defined by the parameter [oPF1/2/3](#) [Table 8, point II](#)) and is signaled by cyclic messages [Eun1/2/3](#) (for the [SEEP](#) method) or [Eun1/3/3](#) (for [oSet](#)) or flashing of the upper right dot during the object analysis for [Fuea](#) ([chapter 7, point d](#)).

The value of the parameter 36/40/44: [Eun1/2/3](#) determines the choice of the PID parameter selection method:

- a) [Eun1/2/3](#) = [Fuea](#) (**continuous mode, smart logic**) - the controller continuously checks whether there are conditions for starting the tuning and tests the object in order to select the appropriate method. The algorithm continuously forces operating in the PID mode. The necessary condition to initiate the PID parameter selection procedure is the location of the PV current measured value outside the dead band defined as the sum of the parameters value of the Pb proportional band and the associated hysteresis H in relation to the SP setpoint, as in figures 9.4.

Fig.9.4.

Location of the deadband for the type of

heating type control ([Eun1/2/3](#) = [indh](#))

and cooling type control ([Eun1/2/3](#) = [oind](#))

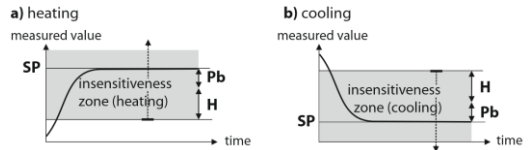

In order to avoid unnecessary activation of tuning, which may delay the course of the process, it is recommended to set the hysteresis H to the highest possible value, not less than 10 ÷ 30% of the process value variation range (e.g. measured temperature). Testing of the object with the short disactivation of the output and the flashing of the upper right dot also takes place in the dead band in case of detecting sudden changes of the measured value PV or the setpoint SP. The choice of the parameter selection method depends on the nature of the initial conditions. For a stabilized controlled quantity, the **step response method (fast)** will be selected, otherwise the oscillation (**longer**) method will be activated.

Automatic selection (continuous mode) enables the optimal selection of PID parameters for the current conditions on the site, without user intervention. It is recommended for variable value control (disturbance of set conditions during operation by modification of e.g. the setpoint SP or the furnace batch).

- b) [Eun1/2/3](#) = [SEEP](#) (**step response method, fast**) - selection of parameters in the step stage (response to step-forcing function). While determining the characteristics of the object, the algorithm does not cause an additional delay in reaching the setpoint SP. This method is dedicated to facilities with stabilized initial controlled value (e.g. temperature in a cold furnace). In order not to disturb the initial conditions, before starting the auto-tuning, turn off the power supply of the actuator (eg heater) with an external switch or use the control start/stop function (keys [F], [SET] or BIN input). The power supply should be switched on immediately after starting the tuning, in the delay phase of switching on the output. Turning on the power at a later stage will result in an incorrect analysis of the object and, as a result, incorrect selection of PID parameters.
- c) [Eun1/2/3](#) = [oSet](#) (**oscillation method, longer**) - selection of parameters using the oscillation method. The algorithm involves the measurement of the oscillation amplitude and period at a slightly lower level (for heating or a slightly higher level for cooling) than the setpoint SP in order to eliminate the danger that the target value will be exceeded during the object test stage. While determining the characteristics of the object, the algorithm causes additional delays in reaching the setpoint. This method is dedicated to objects with unstable initial controlled value (e.g. temperature in a hot furnace).

The algorithms from subpoints b and c consist of the following stages:

- delay in activating the output (approx. 15 seconds - time for switching on the power of the actuator, i.e. heating/cooling power, fan, etc.) and determining the characteristics of the object,

- calculation and permanent saving of parameters (**Pb**, **Ti**, **Td** to the selected PID and **Tc set**, i.e. **PEr1/2/3**, *chapter 8*),

- switching on the control for a given output with new PID settings

The program can discontinue the autotuning **b** or **c** (with the **EE1/2/3** message) in the following situations:

- the initial value of **PV** is higher than the setpoint **SP** for heating or lower than the setpoint for cooling,
- the **SP** setpoint has been changed or the measured value of the **PV** process changes too quickly or too slowly,
- the maximum tuning time (4 hours) has been exceeded

It is recommended to restart the **autotuning b** or **c** after a significant change in the **SP** threshold or the parameters of the control object (eg heating/cooling power, batch mass, initial temperature, etc.).

Autotuning **does not work** in program control (**process controller**) and valve control (**servo**) mode.

9.5. CORRECTION OF PID PARAMETERS

The autotuning function correctly selects the PID regulation parameters for most processes, but sometimes it may be necessary to correct them. Due to the strong interdependence of these parameters (described in *chapters 9,3 and 8, Table 8*), only one of them should be changed and the impact on the process should be observed:

- a) **oscillation around the threshold** - increase the proportional band **Pb**, increase the integration time **Ti**, decrease differentiation time **Td**, (or reduce the pulse period of the output by half, parameter **Tc**)
- b) **slow response** - reduce the **Pb** proportional band, **Td** differentiation time and **Ti** integration time
- c) **overshoot** - increase the **Pb** proportional band, **Td** differentiation time and **Ti** integration time
- d) **instability** - increase the integration time **Ti**.

9.6. PROGRAMMED WORK CHARACTERISTICS. SAMPLE CONFIGURATION.

The controller allows you to create a control program (process controller) consisting of a maximum of 6 segments (3 stages configured with the parameters described in *chapter 8, Table 8, point V*). Each stage (1/2/3) operates in accordance with the control parameters of the assigned setpoint SP (1/2/3), description in *Table 8, point II*.

A program can be assigned to any of the control outputs (1/2/3) with parameter 9/16/23: **EE4/2/3** set to the value **Pr-rc**. Additionally, it is possible to define an auxiliary output (**Pr-fa**), which can be useful for signaling the operating status for individual program stages as well as for switching on additional devices (fans, additional heating sections, etc.) with the manual operation option (when parameter 52/57/62/63: **RS1/1/2/3/E = hRand**).

The program starts at the moment of starting the control (automatically after switching on the power or manually using the **[F]**, **[SET]** function keys or the **BIN** binary input programmed as the start/stop of outputs, *chapter 7.1*) and is always performed from the beginning (1st stage/segment). Successive stages of the process (1/2/3) are signaled by the messages **Pr-1/2/3** appearing every few seconds, alternately with the current setpoint SP (or other programmed parameter 73: **di,bb**) and optionally with the remaining stage time (in hh: mm format with m or 00: ss unit when time < 1min, without unit). During the countdown, the upper right dot flashes (*chapter 7, point d*). The program ends with message **PEnd** and switching off the control output.

Diagram of an exemplary program configuration

Fig.9.6. Diagram of a sample program consisting of 4 segments for the heating type control (**Fun1/2/3 = indH**) is presented in the diagram on the right. At the start of the process (control), the initial setpoint for segment 1 is the current measured value (**PV₀**, e.g. 25°C), target setpoint **SP_c** = **EE1**, which is achieved with the rate (slope) **N1** = **GrA1** (e.g. 25°C/min). After reaching the **SP_c** value and control at this level by the **T2** time set for the 2nd segment = **Er1**, the move to the 3rd section takes place, for which the cooling function with the speed **N3** = **GrA2** is provided (e.g. -10°C/min) up to **SP_{k level}** = **EE2**. During cooling, an auxiliary output can be used to switch on e.g. a fan. The program is stopped (with switching off the control output) after reaching the **SP_k** and going to the 4th segment.

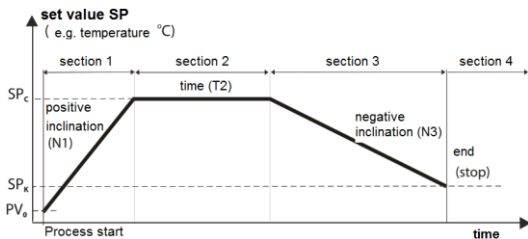

The basic configuration parameters for individual stages are summarized in the table below:

Stage parameters	Stage 1		Stage 2	Stage 3
	segment 1	segment 2	segment 3	segment 4
Type of stage	48: STYP1 = GR1 (2 segments)		53: STYP2 = GR1	58: STYP3 = STOP
Stage SP set point	SPc = SEt1 (e.g. 700°C)		SPk = SEt2 (e.g. 60°C)	not relevant
Slope (°C/min)	N1 = GRP1 (e.g. 25°C/min)		N3 = GRP2 (e.g. -10°C/min)	not relevant
Stage/segment time	T2 = TR1 (e.g. 90min)		TR2 = 0 (segment 2 is missing)	not relevant

9.7. MIXING VALVE CONTROL. SAMPLE CONFIGURATION.

The device allows you to control a servo valve with two open-close contact inputs, without a feedback signal. Standard characteristics (heating/cooling) and operating modes (ON-OFF, PID) are binding for valves controlled by the analog signal mA/V and do not require any additional comments. The servo-type algorithm is implemented on outputs 1 (open) and 2 (close) as a three-point step control. It requires setting parameter 16: **STYP2** to value **VALC** (which also prevents simultaneous activation of both outputs) and other configuration parameters (described in the example below and in *chapter 8*). The total time of opening/closing the valve is defined by parameters 14/21: **PER1/2**.

The valve control is started at the start of control (automatically after switching on the power or manually with the **[F]**, **[SET]** function keys or the **BIN** binary input programmed as output operation start/stop, *chapter 7.1*) and begins with the valve positioning (complete closing) procedure (with the message **VALC**). This procedure also takes place after each change of the pulse period for output 2 (parameter 21: **PER2**).

Sample configuration (ON-OFF for heating with a set temperature of 50°C and a valve opening/closing time of 100s):

- output 1 parameters (*Table 8, point II*, group **OUT1**): **STYP1** = **ONOF** (recommended), **FUN1** = **INH**, **H1** = 0°C, **SEt1** = 50°C, **OPF1** = 1%, **PER1** = 100s,

- output 2 parameters (group **OUT2**): **STYP2** = **VALC**, **FUN2** = **DOF** (deviation from **SEt1**, *Table 8, Fig.8.7*), **H2** = 0°C, **SEt2** = 0.5°C (deviation value), **OPF2** = 100%, **PER2** = 100s, **TR2** = **ON** (emergency status is on)

Tips for adjusting the settings (change only one of the factors and observe the effect on the process):

a) increasing the rate of changes - increase the parameter **OPF1** (recommended 1÷5%) and decrease **PER1**,

b) reducing overshoots and oscillations - reduce **OPF1** (recommended 1 %), increase **PER1**, set

a small dead zone (**SEt2**, e.g. 0.5 C), recommended **H1/2** = 0°C

Alternatively, for the output 1, the PID control (*chapter 9.3*) can also be used with a larger value of **OPF1** (suggested 10÷20%), which will result in reaching the setpoint faster, but at the same time, with incorrectly selected PID parameters, the control may be less accurate (due to overshoots and oscillations). In the range of Pb, the length of the opening pulse (step) will be variable (depending on the measured value PV, according to the principle of PID operation). If the PID algorithm is used, the P variant control is recommended (proportional, e.g. Pb=5°C, Ti=Td=0s) or PD (proportional-differential, e.g. Pb=5°C, Ti=0, Td=30s).

10. SIGNALING MESSAGES AND ERRORS

a) measurement errors:

Code	Possible causes of the error
----	- exceeding the measurement range of the sensor/signal above (----) or below (----)
----	- incorrectly connected or different sensor/signal than set in the configuration (<i>chapter 8, parameter 0: INP</i>)
----	- missing sensor/measuring signal or input damage (----) with a critical message ERR

b) messages and temporary errors (one time or periodic):

Code	Description of the message
Code	the mode of entering the access password to configuration parameters, <i>chapter 8</i>
Err	a wrong password to access the parameter configuration menu has been entered, <i>chapter 8</i>
Conf	entering the parameter configuration menu, <i>chapter 8</i>
block	<ul style="list-style-type: none"> - blockade of quick changes of setpoints (with parameter 68: SEB, <i>chapter 9.1</i>), - blockade of other parameters (e.g. PRSS, when PRrd = oFF or IP addresses in DHCP client mode), - keypad lock with [F], [SET] keys and BIN input (<i>chapter 7.1</i>), - [F]/[SET] key blocked by the active BIN input having the same function, - quick manual mode for [F]/[SET]/BIN blocked by active(permanent) manual mode of the output
Fun1/2/3, Fun1/2/3	implementation of the PID tuning function (step response or oscillation method), <i>chapter 9.4</i>
ErrP1/2/3	<ul style="list-style-type: none"> - error of interrupting PID tuning (<i>chapt.9.4</i>) or the program control due to a change in or incorrect configuration (e.g. when the characteristics is different than heatin/cooling for PID or servo) - erasing the error with the [UP]+[DOWN] or [F], [SET] keys and the BIN input (<i>chapt.7.1</i>)
clear/none (when missing)	erasing errors (one by one) or all with the function assigned to [F]/[SET]/BIN
Start/Stop	start/stop of control with the function assigned to [F]/[SET]/BIN , <i>chapter 7.1</i>
Set1/Set3	change of the setpoint (day/night) for outputs 1 and 3 with the [F]/[SET]/BIN function, <i>chapter.7.1</i>
blon/blOF	keyboard lock on/off with the function assigned to [F]/[SET]/BIN , <i>chap.7.1</i>
hand1/2/3/hOF1/2/3	unconditional manual mode on/off, [F]/[SET]/BIN function, <i>chapter 7.1</i>
Pr-1/2/3, PEnd	process controller function (ramping) on output 1/2/3, <i>chapter 9.6</i>
Stb1/2/3	STB (LATCH) alarm for outputs 1/2/3 (cleared by [F]/[SET]/BIN with the function clear or start/stop)
VALc	the servo valve positioning (closing) procedure is performed (<i>chapter 9.7</i>)
load DEFf	recording of company parameter values (description of the procedure in <i>chapter 8</i>)
ErrE	potential data memory error (erased [UP]+[DOWN] at the power switch-on, with loading company values), if the problem persists, send the device back for repair

11. SERIAL COMMUNICATION. AVAILABLE SOFTWARE AND USB DRIVERS

Communication with the controller is possible through each of the available serial interfaces (independently, i.e. RS485, Ethernet and USB) and can be useful (or necessary) in the following situations:

- remote monitoring and recording of current measurements as well as control of the operating status and control algorithms for outputs,

- quick configuration of parameters, including copying settings to other controllers of the same type

In order to establish long-distance communication, a connection should be made in the **RS485** standard (MODBUS-RTU protocol, *chapters 11.3 and 11.4*) or **Ethernet** using the MODBUS-TCP (*chapter 11.2*) and MQTT protocols (*chapter 11.1*).

When the controller (or RS485 converter) is connected to the computer for the first time via the USB port, the system will start the process of automatic installation of the COM serial port driver (from the **Windows Update** website). Alternatively, you can manually indicate the location of the driver on the computer's disk from the **Device Manager**, following the instructions of the installation wizard (for the regulator, select the "AR2xx

/... "drivers downloaded from the www.apar.pl website or from the ARSOFT-CFG program installation folder, by default „C:\Program Files (x86)\ARSOFT\Drivers\AR2xx...”).

The following applications are available (for Windows 7/8/10 operating systems, downloadable from www.apar.pl/oprogramowanie.html or optionally from a CD or e-mail from the Sales Department):

Name	Description of the program
ARSOFT-CFG (free of charge)	- displaying current measurement data from the connected Apar device - configuration of the measurement input type, indication range, adjustment options, alarms, display, communication, access, etc. (<i>chapter 8</i>) - creation the disc a file with the extension "cfg" containing the current configuration of parameters for reuse (copying of configuration)
APSystem-PC (paid)	- display and recording of current measurements from many devices (via MODBUS-RTU/TCP/ASCII) - visual and audible alarms, e-mail alerts, event reporting, etc.

Detailed descriptions of the above mentioned applications can be found in the installation folders.

NOTE:



Before establishing the connection via **RS485**, make sure that the device parameters (74: **74br**, 76: **Addr** and 75: **74FA**) are compatible with the settings of the computer program. Moreover, set the number of the COM serial port used in the program options (for the RS485 converter it was assigned by the system during the installation of drivers).

Depending on the protocol used, the connection via the **Internet** requires the known public IP address of the broker for the MQTT protocol and the network IP address in the case of MODBUS-TCP (to facilitate access to the network with a variable public IP address, you can start the DDNS service, e.g. in a router). **The selection of network parameters in the controller and the configuration of the router** (including e.g. port redirection for MODBUS-TCP, port forwarding) **should be entrusted to a qualified person (network administrator)**. In addition, pay attention that the firewall does not block the ports and applications used (e.g. ARSOFT-CFG). The unique **MAC** (EUI-48) hardware address of the controller Ethernet interface is available in ARSOFT-CFG (Parameters-> Communication options) and in the MODBUS-RTU/TCP protocol *register map*.

The easiest way to test the correctness of the regulator's operation in the LAN network is to set the Ethernet interface in the automatic mode (parameter 77: **77FA = R77FA**), and then (with the IP address assigned by the DHCP server read from the device) establish connection with the ARSOFT -CFG program or execute the *ping* command from the computer's command line (and optionally *arp -a* for Windows or *arp-scan* for Linux, where we will also get the **MAC address**).

11.1. MQTT PROTOCOL

Popular in IoT/M2M (Internet of Things) applications, the MQTT protocol is a lightweight data transmission protocol based on the publication/subscription pattern (to/from the server). Using the protocol requires a correctly configured Ethernet network interface and MQTT parameters (*chapter 8, Table 8, point VIII*), as well as access to a broker (server) with a fixed numeric IP address (the controller does not support the DNS protocol - text domain names). The MQTT broker can be started independently (eg. Mosquitto) or use the ones available on the Internet (paid or free, e.g. EMQX). Knowing the name of the broker's website, you can check its IP address, e.g. with the *ping* command (from the computer's command line). To read (subscribe) the messages published by the controller from the broker, you can use your own solutions or one of the many applications available on the Internet (such as the free and easy-to-use "*MQTT Dash*" for Android). Establishing a connection with the broker may take some time (usually <1.5 minutes, restarting the device may speed up this process). The current status of the controller's connection the with the MQTT broker is available from the keyboard level (*chapter 7, device status*) and from the MODBUS-TCP/RTU protocols (register at address 31: *Ethernet connection status, chapter 11.5*).

Parameter 91: **91FA** (description in Table 8) is responsible for selecting the content of messages sent cyclically to the

MQTT *broker*. Sample content for the most extensive option (when 91: ~~ADDR~~ = ~~FULL~~, maximum size 99B):
 "AR6x2_1;PV=36.6 °C;MV1=100 %;MV2=100 %;MV3=0 %;cstat=0x0000;outA=7.320 mA;BIN=0" (AR6x2_ ~~Addr~~ = device name; PV = measurement value and unit; MV1 = value of the control signal for output 1; MV2 for the output 2; MV3 for output 3; cstat = work status of control algorithms, description in *chapter 11.5*; outA= analog output signal value mA / V; BIN = binary input status, 0 = closed, i.e. active).

Additionally, in order to optionally authorize the connection, the following fields are set in the MQTT packet: *client ID* (created according to the template "*aparMAC*", where **MAC** is the EU-48 hardware address of the controller, e.g. "*aparFCC23D21C54A*") and *user name* (as "*aparPASS*", the last 2 digits of parameter 70: ~~PASS~~, eg "*apar11*") and *password* (parameter 70: ~~PASS~~).

Protocol parameters useful for advanced needs: version 3.1.1, QOS = 0, retain = 1, keep alive = 0 (off).
 In the event of frequent disconnection with the broker, check the reliability of the network/internet connection (switch), test the possible impact of the message publication period (extend, recommended > 5s, parameter 97: ~~PER~~), as well as MODBUS-TCP communication (temporarily stop if in use).

11.2. MODBUS-TCP SERIAL TRANSMISSION PROTOCOL

The MODBUS-TCP protocol is available for the Ethernet (RJ45) interface and uses the TCP/IP transport layer. Parameters used by this service, such as the TCP port number, are described in *chapter 8, Table 8, point VIII*. The timeout for the MODBUS-TCP transmission, after which the open but unused port is closed, is 60s. Available functions: READ - 3 or 4, WRITE - 6

Table 11.2.1. MODBUS-TCP protocol request frame format for the READ and WRITE functions (frame length - 12B)

MODBUS protocol header (7 bytes)			Function code (READ or WRITE)	register address from <i>Table 11.5</i> (<i>chapter 11.5</i>)	number of registers to read (1 ÷ 13) or value of a register to write
Transaction and protocol identifiers	Length field (value = 6)	Unit ID			
4 bytes	2 bytes	1 byte	1 byte	2 bytes (HB-LB)	2 bytes (HB-LB)

Example 11.2.1. Reading a register with address 0: 0x00 - 0x00 - 0x00 - 0x00 - 0x00 - 0x06 - 0xFF - 0x04 - 0x0000 - 0x0001

Table 11.2.2. Response frame format for the READ function (minimum frame length - 11 bytes):

MODBUS protocol header (7 bytes)			Function code (READ)	number of bytes in the data field (2 ÷ 26)	data field - register value (2B)
Transaction and protocol identifiers	Length field (max 29)	Unit ID			
4 bytes	2 bytes	1 byte	1 byte	1 byte	2÷26 bytes (HB-LB)

Example 11.2.2. The response frame for the register value equal to 0: 0x00 - 0x00 - 0x00 - 0x00 - 0x00 - 0x05 - 0xFF - 0x04 - 0x01 - 0x0000

Table 11.2.3. Response frame format for the WRITE function (frame length - 12 bytes)

copy of the query frame for the WRITE function (Table 11.2.1)

The error codes are the same as for the MODBUS-RTU protocol (*Table 11.4.5*)

Example 11.2.3. Error frame for a non-existing register address to be read: 0x00 - 0x00 - 0x00 - 0x00 - 0x00 - 0x05 - 0xFF - 0x84 - 0x02 - 0x0001

11.3. RS485 COMMUNICATION INTERFACE (acc. To EIA RS-485)

The installation specification for RS485 interface is as follows:

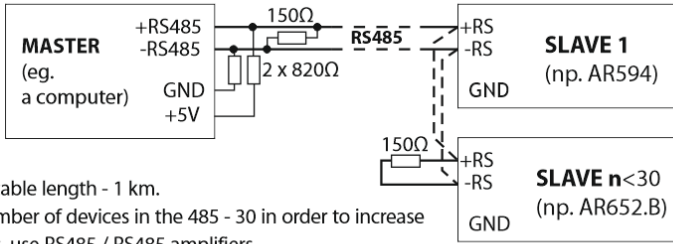

Maximum RS485 cable length - 1 km.

The maximum number of devices in the 485 - 30 in order to increase number of devices, use RS485 / RS485 amplifiers.

Termination resistors when MASTER is at the beginning of the line (fig. above):

- at the beginning of the line - 2 x 820Ω to ground and +5V MASTERA ans150Ω between the lines,
- at the end of the line - 150Ω between lines.

Termination resistors when MASTER is in the middle of the line:

- at the converter - 2 x 820Ω, to ground and +5V the converter,
- at both ends of the line -150Ω between lines.

Equipment from different manufacturers that form the RS485 network (e.g. RS485/USB converters) may have integrated polarizing and terminating resistors; in such a case there is no need to use external elements.

When configuring the network, it is necessary to pay particular attention to the cabling installation recommendations given in *chapter 2*.

11.4. MODBUS-RTU SERIAL TRANSMISSION PROTOCOL (SLAVE)

Baudrate and character format for RS485 and MODBUS-RTU address are set with parameters 74: **74b7**, 75: **74c7**, 76: **74d7** (*chapter 8, Table 8, point VIII*). Available functions: READ = 3 or 4, WRITE = 6.

Table 11.4.1. Query frame format for the READ function (frame length - 8 bytes):

address of the device	function 4 or 3	register address to be read: from <i>Table 11.5 (chap. 11.5)</i>	number of registers to be read: 1 ÷ 13	CRC checksum
1 byte	1 byte	2 bytes (HB-LB)	2 bytes (HB-LB)	2 bytes (LB-HB)

Example 11.4.1. Reading of a register with address 0: 0x01 - 0x04 - 0x0000 - 0x0001 - 0x31CA

Table 11.4.2. Query frame format for the WRITE function (frame length - 8 bytes):

address of the device	function 6	register address to be written: from <i>Table 11.5 (chap. 11.5)</i>	register value to be written	CRC checksum
1 byte	1 byte	2 bytes (HB-LB)	2 bytes (HB-LB)	2 bytes (LB-HB)

Example 11.4.2. Writing a register with address 10 (0xA) with the value 0: 0x01 - 0x06 - 0x000A - 0x0000 - 0xA9C8

Table 11.4.3. Response frame format for the READ function (minimum frame length - 7 bytes):

address of the device	function 4 or 3	number of bytes in the data field (max. 13*2=26 bytes)	data field - register value	CRC checksum
1 byte	1 byte	1 byte	2 ÷ 26 bytes (HB-LB)	2 bytes (LB-HB)

Example 11.4.3. Response frame for register value equal to 0: 0x01 - 0x04 - 0x02 - 0x0000 - 0xB930

Table 11.4.4. Reply frame format for the WRITE function (frame length - 8 bytes):

copy of the query frame for the WRITE function (<i>Table 11.4.2</i>)
--

Table 11.4.5. Special reply (errors: function field = 0x84 or 0x83 in the case of the READ function and 0x86 in the case of the WRITE function):

Error code (HB-LB in data field)	Error description
0x0001	non-existing register address
0x0002	incorrect register value to be written
0x0003	incorrect function number

Example 11.4.5. Error frame for a non-existing register address to be read:

0x01 - 0x84 - 0x02 - 0x0001 - 0x5130

11.5. MAP OF DEVICE REGISTERS FOR MODBUS-RTU/TCP

Table 11.5. Map of registers for the MODBUS-RTU and MODBUS-TCP protocols

Register address HEX (DEC)	Value (HEX or DEC)	Description of register and access type (R- read only register, R/W - read and write register)	
0x00 (0)	-1999 ÷ 19999	current measurement value (PV) in the U2 code, without a comma (for thermometric inputs, resolution 0.1°C)	R
0x01 (1)	6520 ÷ 6529	device type identifier	R
0x02 (2)	400 ÷ 999	controller firmware version	R
0x03 ÷ 0x05	0	not used or reserved	R
0x06 (6)	0 ÷ 65535	Status of algorithms and control functions and status of outputs/alarms: - status of outputs/alarms 1, 2, 3 (bits 0, 1, 2 , bit=1= output enabled), - STB (LATCH) alarms for outputs 1, 2, 3 (bits 3, 4, 5 , bit=1=active), - quick manual mode for outputs 1, 2, 3 (bits 6, 7, 8 , bit=1=active), - PID tuning status for any of the outputs (bit 12 , bit=1=active), - error EEP/0/8 PID, etc. (bit 13 , bit=1=active), description in <i>chapter 10</i> , point b, - change of the setpoint 555/6553 (bit 14 , bit=1= 555), <i>chap.10 b</i> , - status of the start/stop function for [F]/[SET]/BIN (bit 15 , bit=1=start), <i>chap.7.1</i>	R
0x07 (7)	0 ÷ 20000	current state of the analog output (0 ÷ 20000 µA or 0 ÷ 10000 mV)	R
0x08 (8)	-100 ÷ 700	temperature of cold ends for thermocouples (resolution 0.1°C)	R
0x09 ÷ 0x0B	0 ÷ 100	MV control signal value [%] for outputs 1, 2 and 3	R
0x0C (12)	0 ÷ 65535	device status: - type of built-in mA/V analogue output (bit 0 , bit=1=V), - BIN input status (bit 1 , bit=1=active input=closed), <i>chapter 7.1</i> , - presence of Ethernet and RS485 modules (bits 4, 5 , bit=1=available), - AR602 type tag.B (bit 6 , bit=1=AR602.B), - LED display type (bit 7 , bit=1=small=AR602/642/662.B), <i>chap.7d</i> , - USB connection status (bit 8 , bit=1=connected),	R
0x0D ÷ 0x1E	0	not used or reserved	R
0x1F (31)	0 ÷ 65535	connection status of the Ethernet interface and the MODBUS-TCP and MQTT protocols: - LAN connection status, link-up (bit 0 , bit=1=connected), - connection with the MQTT broker status (bits 1, 2 , bit1=bit2=1=connected), - TCP port for MODBUS-TCP status (bits 6, 7, 8 ,	R

		bit6=bit7=1=connected),	
0x20 ÷ 0x22	0 ÷ 65535	unique MAC hardware address of the Ethernet interface (EUI-48)	
Configuration parameters (the collective list of parameters can be found in <i>chapter 8, Table 8</i>)			
Register (parameter) address = 35 + parameter index from <i>Table 8</i> (e.g. address=35 for parameter 0: 0x20), Register (parameter) value = value from <i>Table 8</i> (e.g. 0 for 0: 0x00)			R/W

12. OWN NOTES

X-ON Electronics

Largest Supplier of Electrical and Electronic Components

Click to view similar products for [Apar](#) manufacturer:

Other Similar products are found below :

[AR101/PT100/B/3](#) [AR102/PT100/A/3-PRZEWDOWY](#) [AR239](#) [AR247/1/P/P/P/WA](#) [AR247/1/S/P/P/WA](#) [AR247/2/P/P/P/WA](#)
[AR247/2/P/P/P/WA/RS485](#) [AR247/3/P/P/P/WA](#) [AR247/3/P/P/S/WA](#) [AR247/3/S/P/S/WA/RS485](#) [AR250/I](#) [AR250/U](#) [AR252/I](#) [AR252/LCD/I](#)
[AR252/LCD/U](#) [AR252/RS485](#) [AR252/U](#) [AR257/I](#) [AR257/LCD/I](#) [AR257/LCD/RS485](#) [AR257/LCD/U](#) [AR257/RS485](#) [AR257/U](#) [AR258/I](#)
[AR258/LCD/I](#) [AR258/LCD/RS485](#) [AR258/LCD/U](#) [AR258/RS485](#) [AR258/U](#) [AR259/I](#) [AR259/LCD/I](#) [AR259/LCD/RS485](#) [AR259/LCD/U](#)
[AR259/RS485](#) [AR259/U](#) [AR281](#) [AR500/R](#) [AR507/S1](#) [AR517/WA](#) [AR540/S1/P/P/RS485/WA](#) [AR540/S1/P/P/RS485/WU](#)
[AR540/S2/P/P/RS485/WA](#) [AR540/S2/P/P/RS485/WU](#) [AR550/I](#) [AR550/U](#) [AR553/I](#) [AR553/LCD/I](#) [AR553/U](#) [AR580/I](#) [AR580/U](#)