

# AP6985GN2-HF

**Halogen-Free Product**



**Advanced Power  
Electronics Corp.**

*P-CHANNEL ENHANCEMENT MODE*

*POWER MOSFET*

- ▼ Capable of 1.8V Gate Drive
- ▼ Small Size & Lower Profile
- ▼ Halogen Free & RoHS Compliant Product

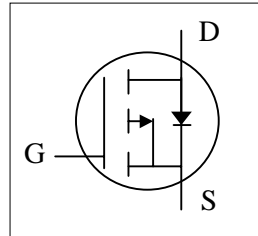

$BV_{DSS}$	-20V
$R_{DS(ON)}$	26m $\Omega$
$I_D$	-8A

## Description

AP6985 series are from Advanced Power innovated design and silicon process technology to achieve the lowest possible on-resistance and fast switching performance. It provides the designer with an extreme efficient device for use in a wide range of power applications.

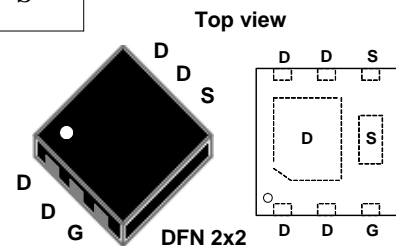

## Absolute Maximum Ratings @ $T_j=25^\circ\text{C}$ (unless otherwise specified)

Symbol	Parameter	Rating	Units
$V_{DS}$	Drain-Source Voltage	-20	V
$V_{GS}$	Gate-Source Voltage	$\pm 8$	V
$I_D @ T_A=25^\circ\text{C}$	Drain Current <sup>3</sup> @ $V_{GS}=4.5\text{V}$	-8	A
$I_D @ T_A=70^\circ\text{C}$	Drain Current <sup>3</sup> @ $V_{GS}=4.5\text{V}$	-6.4	A
$I_{DM}$	Pulsed Drain Current <sup>1</sup>	-30	A
$P_D @ T_A=25^\circ\text{C}$	Total Power Dissipation <sup>3</sup>	2.4	W
$T_{STG}$	Storage Temperature Range	-55 to 150	$^\circ\text{C}$
$T_J$	Operating Junction Temperature Range	-55 to 150	$^\circ\text{C}$

## Thermal Data

Symbol	Parameter	Value	Unit
$R_{thj-a}$	Maximum Thermal Resistance, Junction-ambient <sup>3</sup>	52	$^\circ\text{C}/\text{W}$



# AP6985GN2-HF

## Electrical Characteristics @T<sub>j</sub>=25°C (unless otherwise specified)

Symbol	Parameter	Test Conditions	Min.	Typ.	Max.	Units	
BV <sub>DSS</sub>	Drain-Source Breakdown Voltage	V <sub>GS</sub> =0V, I <sub>D</sub> =-250uA	-20	-	-	V	
R <sub>DS(ON)</sub>	Static Drain-Source On-Resistance <sup>2</sup>	V <sub>GS</sub> =-4.5V, I <sub>D</sub> =-7A	-	23	26	mΩ	
		V <sub>GS</sub> =-2.5V, I <sub>D</sub> =-4A	-	29	35	mΩ	
		V <sub>GS</sub> =-1.8V, I <sub>D</sub> =-2A	-	34	45	mΩ	
V <sub>GS(th)</sub>	Gate Threshold Voltage	V <sub>DS</sub> =V <sub>GS</sub> , I <sub>D</sub> =-250uA	-0.3	-	-1	V	
g <sub>fs</sub>	Forward Transconductance	V <sub>DS</sub> =-5V, I <sub>D</sub> =-7A	-	21	-	S	
I <sub>DSS</sub>	Drain-Source Leakage Current	V <sub>DS</sub> =-16V, V <sub>GS</sub> =0V	-	-	-10	uA	
I <sub>GSS</sub>	Gate-Source Leakage	V <sub>GS</sub> =±8V, V <sub>DS</sub> =0V	-	-	±100	nA	
Q <sub>g</sub>	Total Gate Charge	I <sub>D</sub> =-7A	-	16	27	nC	
Q <sub>gs</sub>	Gate-Source Charge		V <sub>DS</sub> =-10V	-	3	-	nC
Q <sub>gd</sub>	Gate-Drain ("Miller") Charge		V <sub>GS</sub> =-4.5V	-	6	-	nC
t <sub>d(on)</sub>	Turn-on Delay Time	V <sub>DS</sub> =-10V	-	9	-	ns	
t <sub>r</sub>	Rise Time		I <sub>D</sub> =-1A	-	15	-	ns
t <sub>d(off)</sub>	Turn-off Delay Time	R <sub>G</sub> =3.3Ω	-	60	-	ns	
t <sub>f</sub>	Fall Time	V <sub>GS</sub> =-5V	-	32	-	ns	
C <sub>iss</sub>	Input Capacitance	V <sub>GS</sub> =0V	-	1655	2640	pF	
C <sub>oss</sub>	Output Capacitance		V <sub>DS</sub> =-10V	-	175	-	pF
C <sub>rss</sub>	Reverse Transfer Capacitance		f=1.0MHz	-	150	-	pF
R <sub>g</sub>	Gate Resistance	f=1.0MHz	-	10	20	Ω	

## Source-Drain Diode

Symbol	Parameter	Test Conditions	Min.	Typ.	Max.	Units
V <sub>SD</sub>	Forward On Voltage <sup>2</sup>	I <sub>S</sub> =-2A, V <sub>GS</sub> =0V	-	-	-1.2	V
t <sub>rr</sub>	Reverse Recovery Time	I <sub>S</sub> =-7A, V <sub>GS</sub> =0V, dI/dt=100A/μs	-	27	-	ns
Q <sub>rr</sub>	Reverse Recovery Charge		-	24	-	nC

### Notes:

1. Pulse width limited by Max. junction temperature.

2. Pulse test

3. Surface mounted on 1 in<sup>2</sup> 2oz copper pad of FR4 board, t ≤ 10s ; 165°C/W when mounted on min. copper pad.

THIS PRODUCT IS SENSITIVE TO ELECTROSTATIC DISCHARGE, PLEASE HANDLE WITH CAUTION.

USE OF THIS PRODUCT AS A CRITICAL COMPONENT IN LIFE SUPPORT OR OTHER SIMILAR SYSTEMS IS NOT AUTHORIZED.

APEC DOES NOT ASSUME ANY LIABILITY ARISING OUT OF THE APPLICATION OR USE OF ANY PRODUCT OR CIRCUIT DESCRIBED HEREIN; NEITHER DOES IT CONVEY ANY LICENSE UNDER ITS PATENT RIGHTS, NOR THE RIGHTS OF OTHERS.

APEC RESERVES THE RIGHT TO MAKE CHANGES WITHOUT FURTHER NOTICE TO ANY PRODUCTS HEREIN TO IMPROVE RELIABILITY, FUNCTION OR DESIGN.

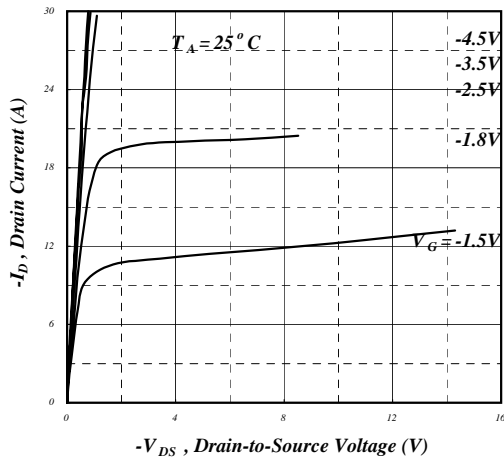

Fig 1. Typical Output Characteristics

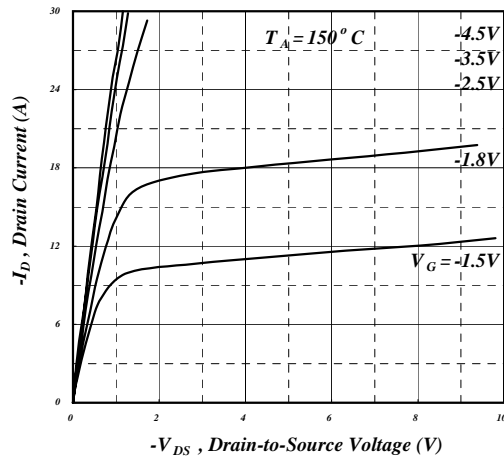

Fig 2. Typical Output Characteristics

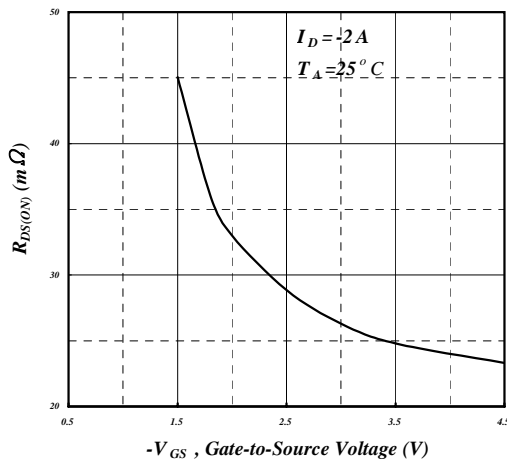

Fig 3. On-Resistance v.s. Gate Voltage

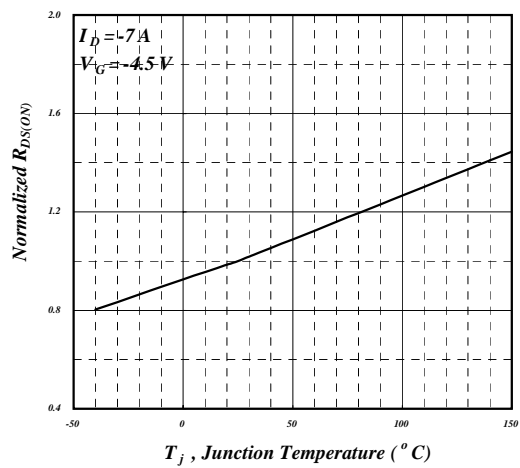

Fig 4. Normalized On-Resistance v.s. Junction Temperature

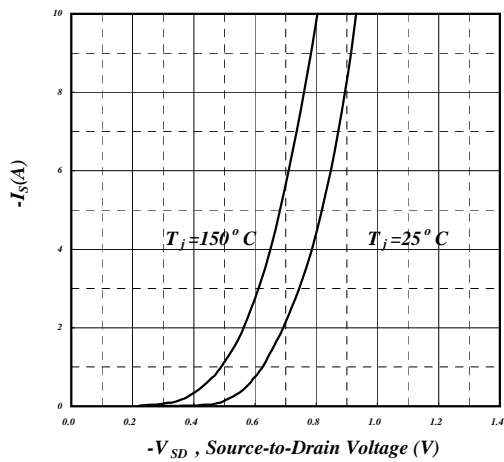

Fig 5. Forward Characteristic of Reverse Diode

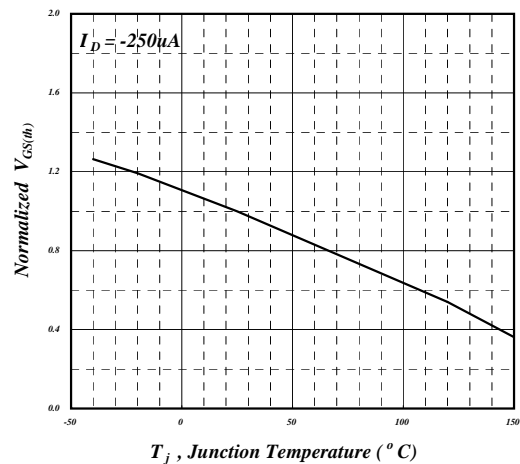

Fig 6. Gate Threshold Voltage v.s. Junction Temperature

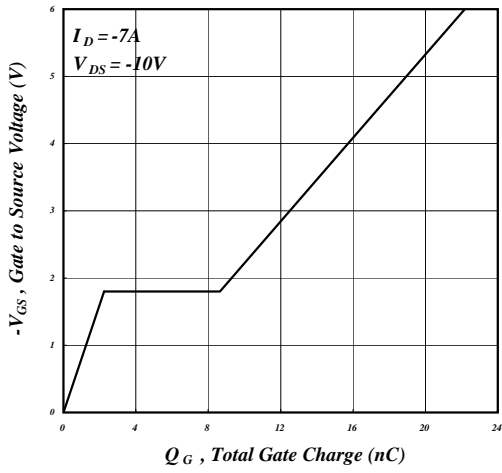

Fig 7. Gate Charge Characteristics

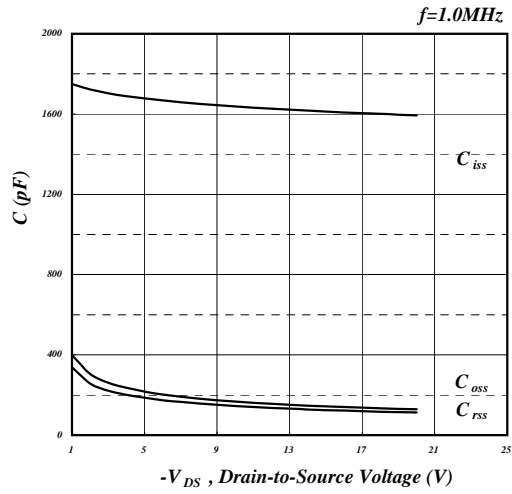

Fig 8. Typical Capacitance Characteristics

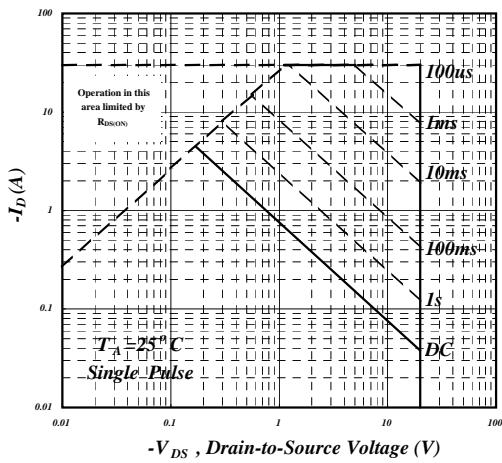

Fig 9. Maximum Safe Operating Area

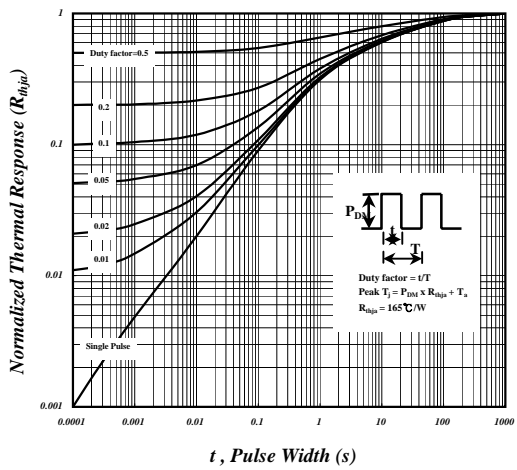

Fig 10. Effective Transient Thermal Impedance

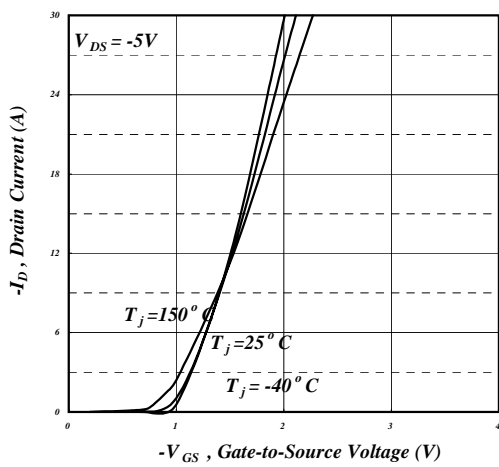

Fig 11. Transfer Characteristics

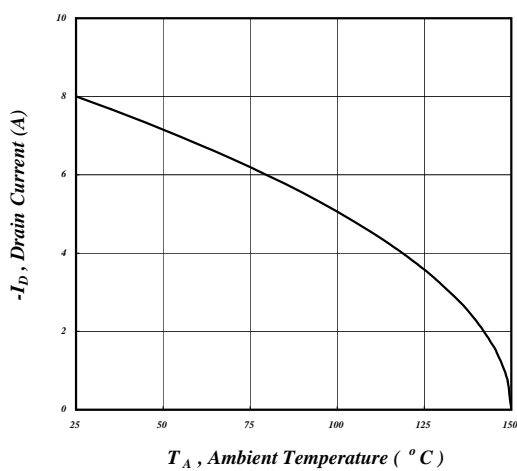
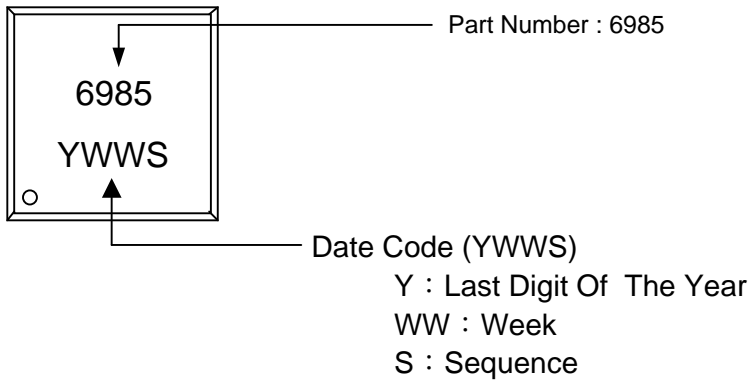

Fig 12. Drain Current v.s. Ambient Temperature



---

## MARKING INFORMATION



## X-ON Electronics

Largest Supplier of Electrical and Electronic Components

*Click to view similar products for [MOSFET](#) category:*

*Click to view products by [APEC](#) manufacturer:*

Other Similar products are found below :

[614233C](#) [648584F](#) [MCH3443-TL-E](#) [MCH6422-TL-E](#) [NTNS3A92PZT5G](#) [IRFD120](#) [IRFF430](#) [JANTX2N5237](#) [2N7000](#) [AOD464](#)  
[2SK2267\(Q\)](#) [2SK2545\(Q,T\)](#) [405094E](#) [423220D](#) [MIC4420CM-TR](#) [VN1206L](#) [614234A](#) [715780A](#) [SSM6J414TU,LF\(T](#) [751625C](#)  
[IPS70R2K0CEAKMA1](#) [BSF024N03LT3 G](#) [PSMN4R2-30MLD](#) [TK31J60W5,S1VQ\(O](#) [2SK2614\(TE16L1,Q\)](#) [DMN1017UCP3-7](#)  
[EFC2J004NUZTDG](#) [FCAB21350L1](#) [P85W28HP2F-7071](#) [DMN1053UCP4-7](#) [NTE2384](#) [NTE2969](#) [NTE6400A](#) [DMC2700UDMQ-7](#)  
[DMN2080UCB4-7](#) [DMN61D9UWQ-13](#) [US6M2GTR](#) [DMN31D5UDJ-7](#) [SSM6P54TU,LF](#) [DMP22D4UFO-7B](#) [IPS60R3K4CEAKMA1](#)  
[DMN1006UCA6-7](#) [DMN16M9UCA6-7](#) [STF5N65M6](#) [IRF40H233XTMA1](#) [IPSA70R950CEAKMA1](#) [IPSA70R2K0CEAKMA1](#) [STU5N65M6](#)  
[C3M0021120D](#) [DMN6022SSD-13](#)