

1400N series

Momentary pushbutton switches •
snap-in mounting • square plunger



DISTINCTIVE FEATURES

Butt action contacts, double break
Solder lug, straight PC and quick-connect terminals



ELECTRICAL SPECIFICATIONS

- Max. current/voltage rating with resistive load :
 - silver contacts (A) : 6 A 12 VDC
 - silver plated copper contacts (C) : 3 A 12 VDC
- Initial contact resistance : 10 mΩ
- Insulation resistance : 1,000 MΩ min. at 500 VDC
- Dielectric strength :
 - 1,500 Vrms 50 Hz min. between terminals
 - 2,000 Vrms 50 Hz min. between terminals and metal panel
- Electrical life : 10,000 cycles at full load



GENERAL SPECIFICATIONS

- Panel thickness : 2 mm (.078) max.
- Operating temperature : -20 °C to +55 °C (-4 °F to +131 °F)



MATERIALS

- Case : polyamide
- Plunger : polyamide
- Contacts :
 - A : silver
 - C : gold plated silver

APEM products may be recycled at end-of-life for the re-claiming of valuable metal components.

The company reserves the right to change specifications without notice.



1400N series

Momentary pushbutton switches • snap-in mounting • square plunger



PANEL CUT-OUT

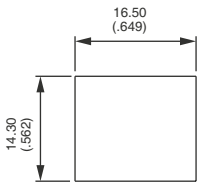

TERMINALS

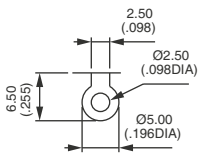

Solder lug

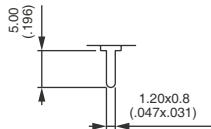

Straight PC

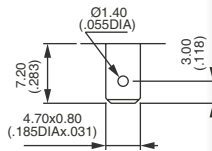

Quick-connect



ELECTRICAL FUNCTIONS

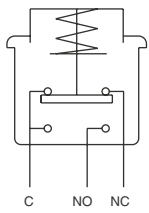

1400N series

Momentary pushbutton switches •
snap-in mounting • square plunger



BUILD YOUR PART NUMBER

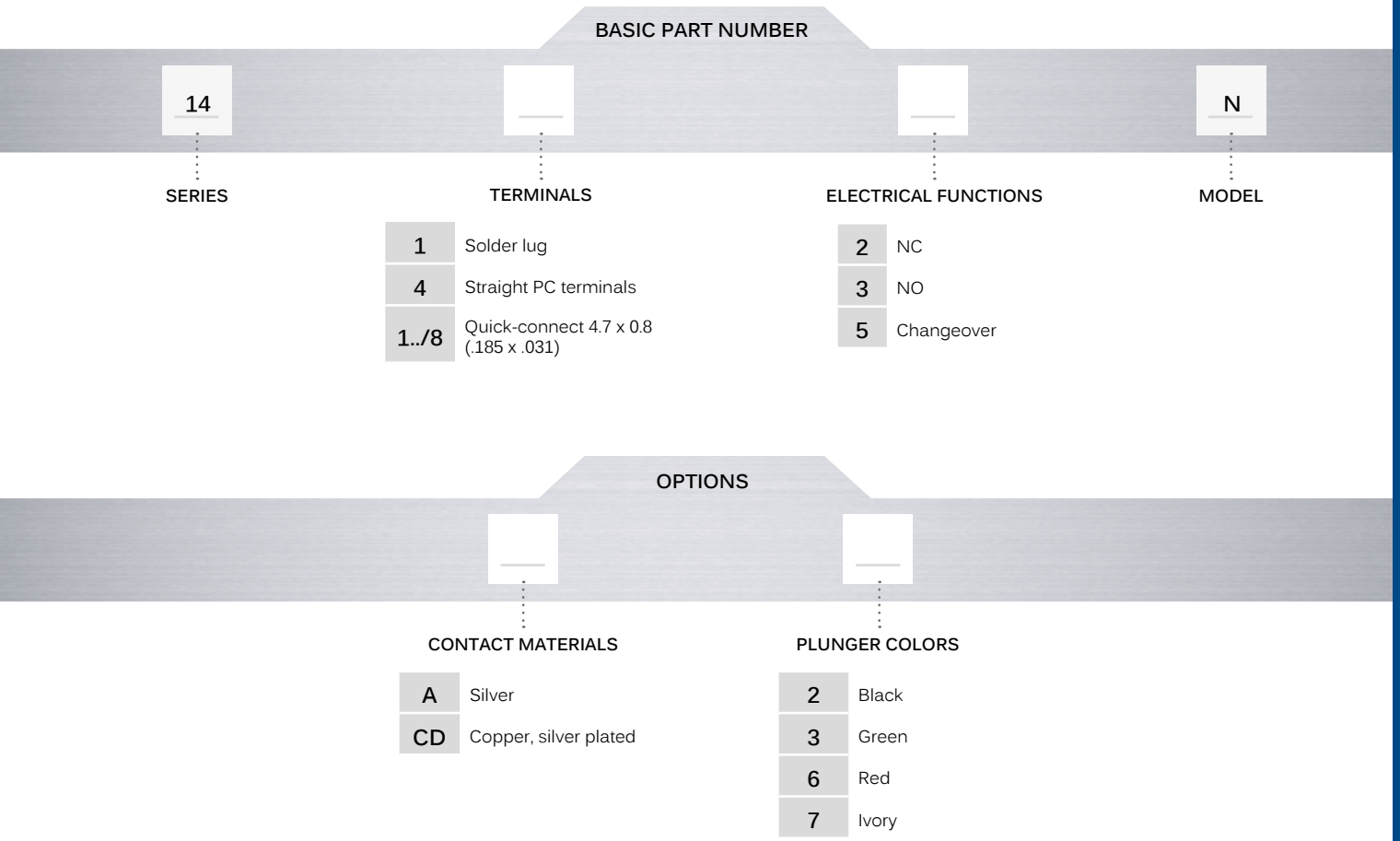

ABOUT THIS SERIES

On the following pages, you will find successively basic part numbers of switches and options in the same order as in above chart.





Notice : please note that not all combinations of above numbers are available. Refer to following pages for further information.

1400N series

Momentary pushbutton switches • snap-in mounting • square plunger

SOLDER LUG TERMINALS



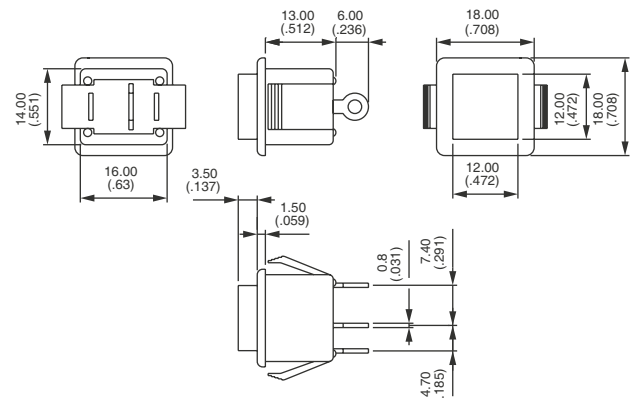

- 1412N  Normally Closed
- 1413N  Normally Open
- 1415N  Changeover



STRAIGHT PC TERMINALS



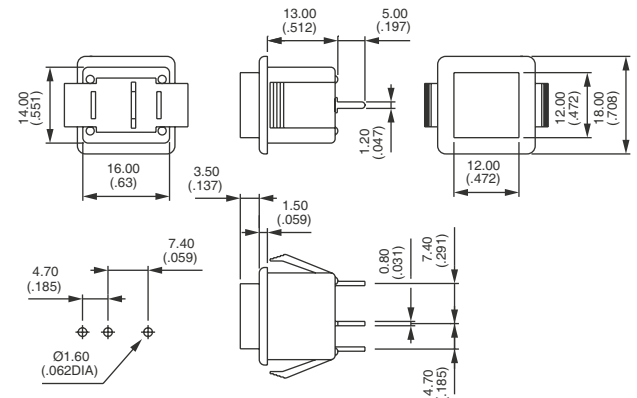

- 1442N  Normally Closed
- 1443N  Normally Open
- 1445N  Changeover



QUICK-CONNECT TERMINALS 4.7 X 0.8 (.185 X .031)



- 1412N/8  Normally Closed
- 1413N/8  Normally Open
- 1415N/8  Changeover

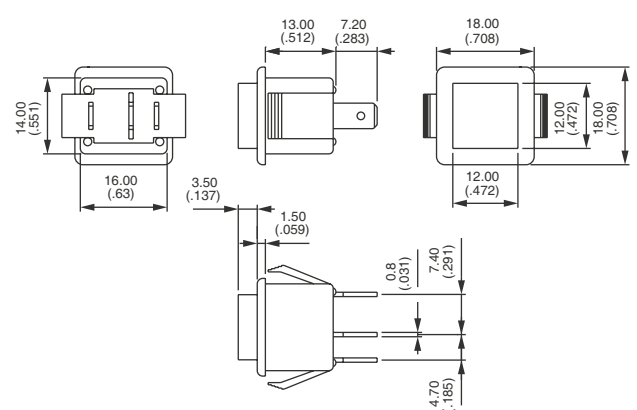

CONTACT MATERIALS



- A Silver
- C Copper, silver plated

1400N series

Momentary pushbutton switches •
snap-in mounting • square plunger

PLUNGER COLORS



- 2 Black (standard)
- 3 Green
- 6 Red
- 7 Ivory

ⓘ Switch frame supplied in black.

X-ON Electronics

Largest Supplier of Electrical and Electronic Components

Click to view similar products for [Pushbutton Switches](#) category:

Click to view products by [Apem](#) manufacturer:

Other Similar products are found below :

[8940K2012](#) [LW1L-M1C10V-A](#) [LW1L-M1C70-A](#) [LW2L-A1C20M-GD](#) [LW2L-M1C20M-A](#) [60324L](#) [M22-D-R-GB0/K11](#) [M7E-HRN2](#)
[67021K512](#) [67081K512X](#) [701PB580](#) [7190K101](#) [7199K101](#) [810K12910](#) [810KSV30B](#) [MML21EA2ADK](#) [MML21KA3ABK](#)
[MML23KA3AC05K-001](#) [MML23KW3AA01W](#) [8418K2](#) [8442K3](#) [8450K1](#) [860K11911T01A](#) [861901](#) [861K11911T01A07](#)
[861K13810T00A14](#) [861K13911](#) [8646AB6X718UL](#) [8646ABUL](#) [9001KXRK](#) [907AYY100](#) [PMHD155A1](#) [95-313.000](#)
[9533CD4+U574+U4922](#) [95-414.000](#) [99-450.837](#) [99-453.837](#) [PV3H2B0NN-341](#) [1203MRA](#) [A22NZBGANGA](#) [A22NZBMMNGA](#)
[A22NZBNANGA](#) [A22NZMPATRA](#) [A2PMA1X03EC56](#) [A3A-5123-02](#) [A3A-7140](#) [A3A-7310](#) [A3A-7340](#) [A3U-TMW-A2C-5M](#) [A595](#)