

25000N series

Professional slide switches

Distinctive features and specifications



- Professional grade slide switches for PC boards
- Approved according to UL 1054
- Wave solderable
Not washable in aqueous process
- Available with flush, high and side actuator
- Various actuator lengths

ELECTRICAL SPECIFICATIONS

- Max. current/voltage rating with resistive load :
 - silver contacts (A) : 1A 30VDC
 - gold plated brass contacts (LD) : 100mA 30VDC
- Minimum load :
 - silver contacts (A) : 100mA 10V
 - gold plated brass contacts (LD) : 10 μ A 5VDC - 10mA 50mV
- Initial contact resistance :
 - silver contacts (A) : 10m Ω max.
 - gold plated brass contacts (LD) : 50m Ω max.
- Insulation resistance : 1.000 M Ω min. at 500VDC
- Dielectric strength :
 - 1.000 Vrms 50 Hz min. between terminals
 - 2.000 Vrms 50 Hz min. between poles
 - 2.000 Vrms 50 Hz min. between terminals and frame
- Electrical life : 10.000 cycles at full load
- Low level or mechanical life : 20.000 cycles

MATERIALS

- Case : PBT
- Actuator : polyamide, glass filled
- Cover : polyamide, glass filled
- Contacts
 - A : silver
 - LD : brass, gold plated
- Terminal seal : epoxy

APPROVALS

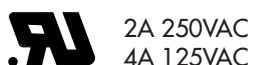

Availability : consult factory for details of approved models.

Marking : To order switches marked UL, complete the "Options and Approvals" box of ordering format.

GENERAL SPECIFICATIONS

- Operating temperature :
 - 40°C to +85°C
- Overall length : 14 mm (.551)
- Actuator height (outside case) :
 - high : 2,80 mm (.110)
 - extra high : 6 mm (.236)
 - side : 2,3 mm (.090)
 - long side : 6 mm (.236)
- Travel : 4 mm (.157)

25000N series

Professional slide switches

Overview

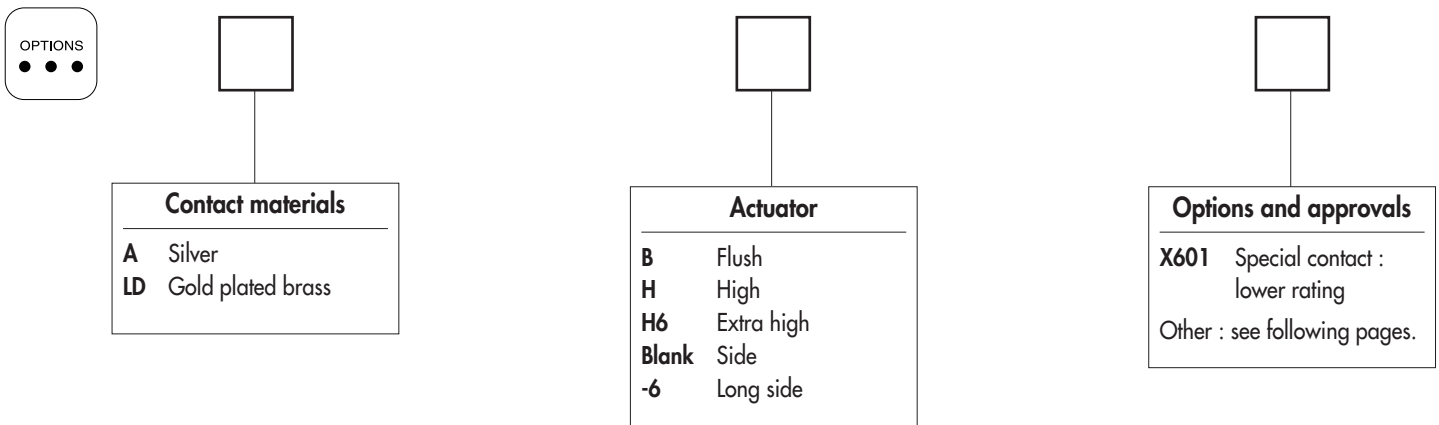
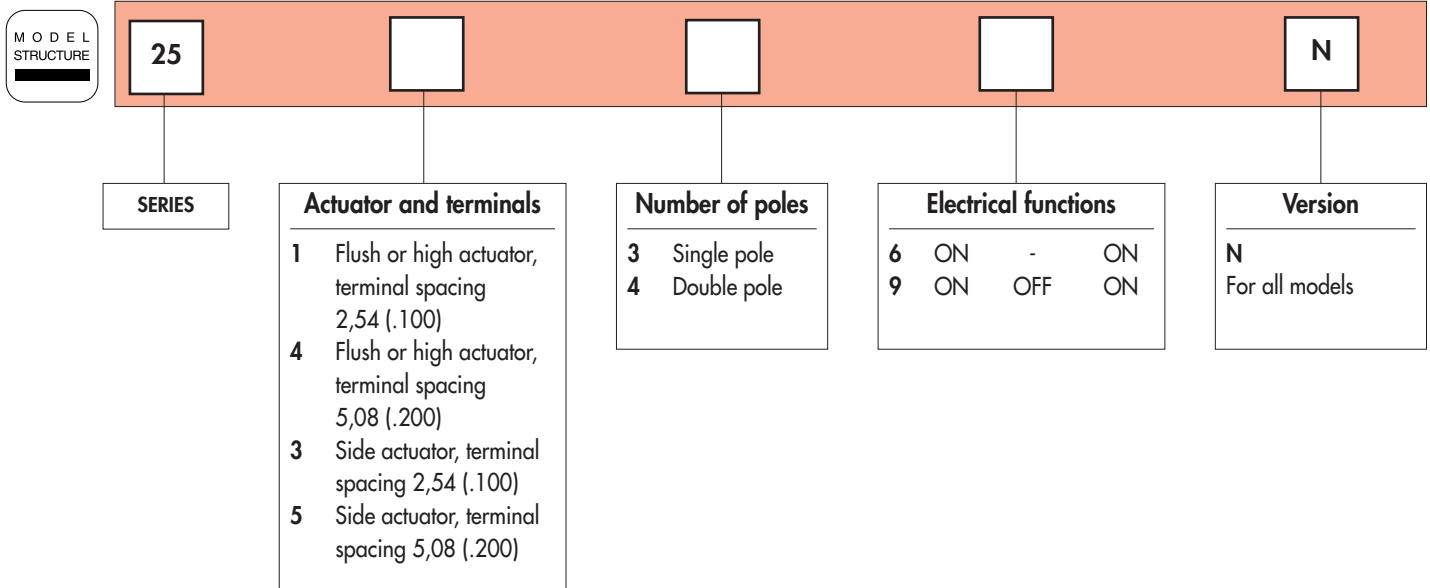

E

ABOUT THIS SERIES

On the following pages, you will find successively :
 - model structure of switches (including actuator options)
 - contact options

Dimensions : first dimensions are in mm while inches are shown as bracketed numbers.

 **NOTICE** : please note that not all combinations of above numbers are available. Refer to the following pages for further information.

 **Packaging unit** : single pole : 100 pieces - double pole : 50 pieces

25000N series

Professional slide switches

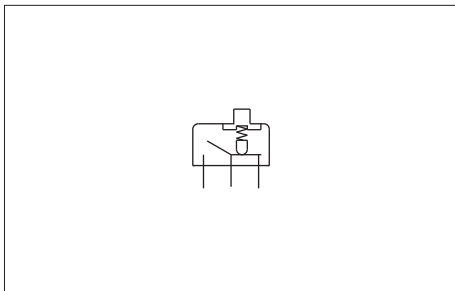
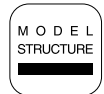

- Epoxy sealed terminals standard
- 1 and 2 pole configurations
- **UL approved models** : see next page.

MODEL STRUCTURE

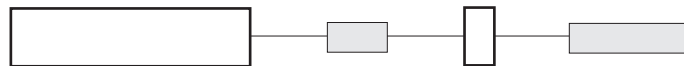

Flush actuator : 25000NB



Terminal spacing
2,54 (.100)

Single pole
25136N B
25139N B

Double pole
25146N B
25149N B

Terminal spacing
5,08 (.200)

Single pole
25436N B
25439N B

Double pole
25446N B
25449N B

Shown with 2,54 mm terminal spacing

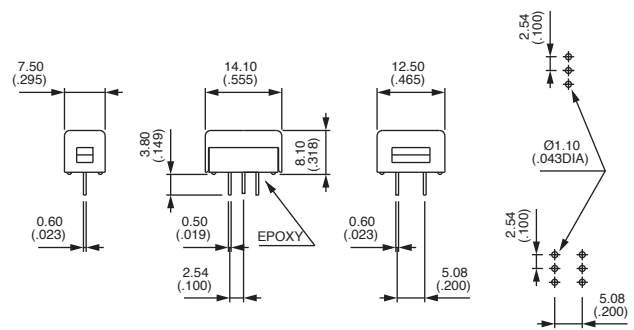

High actuator : 25000NH



Terminal spacing
2,54 (.100)

Single pole
25136N H
25139N H

Double pole
25146N H
25149N H

Terminal spacing
5,08 (.200)

Single pole
25436N H
25439N H

Double pole
25446N H
25449N H

Shown with 5,08 mm terminal spacing

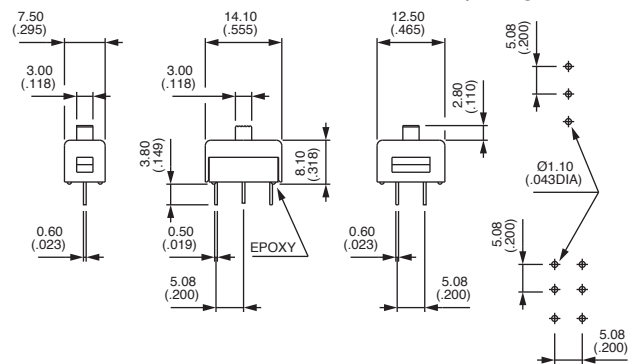

Extra high actuator : 25000NH6



Terminal spacing
2,54 (.100)

Single pole
25136N H6
25139N H6

Double pole
25146N H6
25149N H6

Terminal spacing
5,08 (.200)

Single pole
25436N H6
25439N H6

Double pole
25446N H6
25449N H6

Shown with 5,08 mm terminal spacing

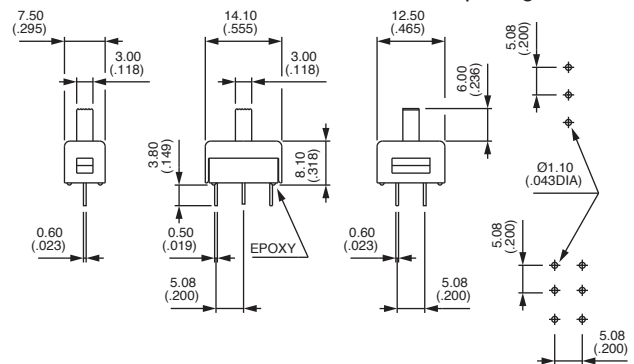

25000N series

Professional slide switches



Side actuator : 25000N



Terminal spacing
2,54 (.100)

Single pole
25336N
25339N

Double pole
25346N
25349N

Terminal spacing
5,08 (.200)

Single pole
25536N
25539N

Double pole
25546N
25549N

Shown with 2,54 mm terminal spacing

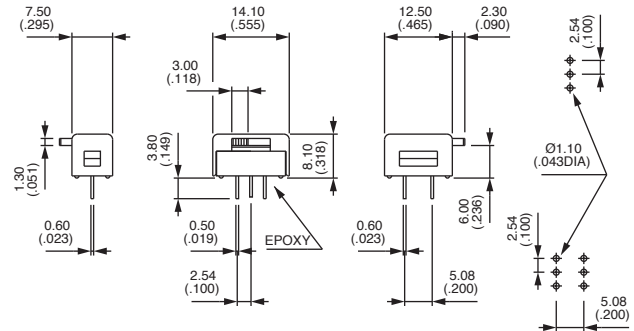

Long side actuator : 25000N-6



Terminal spacing
2,54 (.100)

Single pole
25336N -6
25339N -6

Double pole
25346N -6
25349N -6

Terminal spacing
5,08 (.200)

Single pole
25536N -6
25539N -6

Double pole
25546N -6
25549N -6

Shown with 2,54 mm terminal spacing

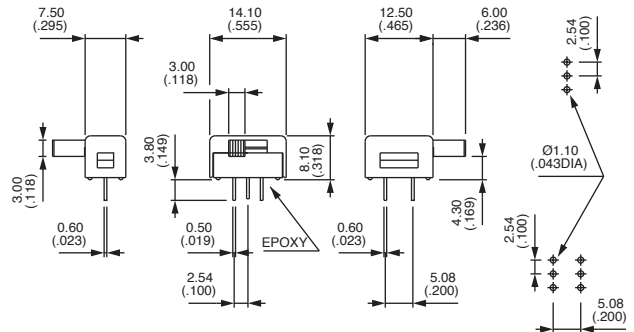

PCB MOUNTING

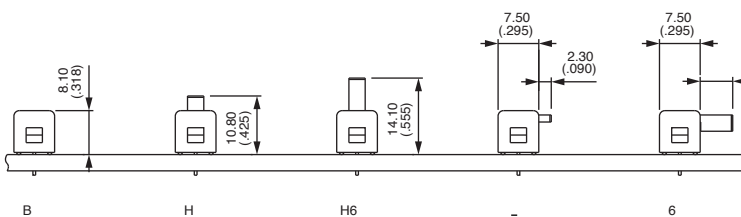

POSITIONS AND CONNECTIONS

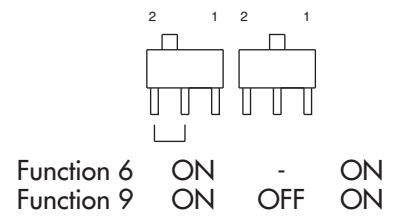

E

CONTACT MATERIALS

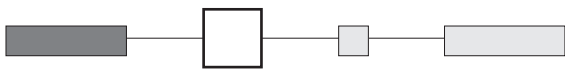

A Silver
LD Brass, gold plated

OPTIONS AND APPROVALS

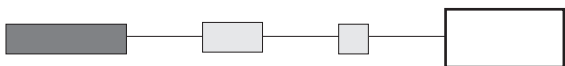

- X601** Silver plated brass contacts - Lower rating 3VA 30VDC. Min quantity : 5.000 pieces per model and shipment.
- X693** Flame retardant plastic materials
- X693UL** Switches approved and marked UL (silver contacts only)

X-ON Electronics

Largest Supplier of Electrical and Electronic Components

Click to view similar products for [Slide Switches](#) category:

Click to view products by [Apem](#) manufacturer:

Other Similar products are found below :

[6-1437581-1](#) [M43R](#) [MHS123K15D](#) [MHS133K](#) [MMD](#) [MSS12A](#) [1825074-1](#) [1825160-3](#) [1825167-2](#) [1825289-7](#) [K232CB](#) [25139NLDB](#)
[25449NAH](#) [SLB1240R45](#) [1825078-1](#) [1825080-4](#) [1825269-1](#) [1825270-2](#) [STS141RA04](#) [T2215BEN506](#) [GH46P000001](#) [GH49P010001](#)
[M42A](#) [AYZ0202AG](#) [L203091MS02Q](#) [4-1437581-7](#) [48BFSP3M2QT](#) [1101M1S3ZB8E2](#) [1-1437581-1](#) [EG1218REDACTUATOR](#)
[MSS2225G04](#) [MSS42G](#) [T105S1CWZBE](#) [SLB124145](#) [SLB1280R5](#) [TG39W000050](#) [25149NAH](#) [25439NAH](#) [25436NAH6](#) [TG36Y000050](#)
[NK236X693](#) [SL-1211C1B8](#) [46204LRX](#) [1977143-4](#) [1977144-4](#) [HASS0194](#) [JS0001](#) [SSJ12R04](#) [880092](#) [GR5-1323-0800](#)