

6000 series

Toggle switches for military applications



DISTINCTIVE FEATURES

Suitable for military or industrial applications
Sealing and locking lever options available
Black finish on actuator and bushing



ELECTRICAL SPECIFICATIONS

- Max. current/voltage rating : see table below
- Initial contact resistance : 10 mΩ max.
- Insulation resistance : 1,000 MΩ min. at 500 VDC
- Dielectric strength :
2,000 Vrms 50 Hz min. between terminals
3,000 Vrms 50 Hz min. between terminals and frame
- Electrical life : 10,000 cycles at full load

Current/Voltage Rating	
Resistive load	6.5 A 30 VDC
Inductive load	5 A 30 VDC
Lamp load	3 A 30 VDC



GENERAL SPECIFICATIONS

- Torque : 1.50 Nm (1.10 Ft.lb) max. applied to nut
- Panel thickness : 5 mm (.196) max.
- Operating temperature : -40 °C to +85 °C (-40 °F to +185 °F)



MATERIALS

- Case : diallylphthalate (DAP)
- Actuator : brass, chrome plated, black
- Bushing : brass, chrome plated, black
- Contacts : A : silver

The company reserves the right to change specifications without notice.



6000 series

Toggle switches for military applications

ELECTRICAL FUNCTIONS

→ KEYWAY

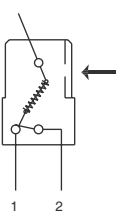

1 pole

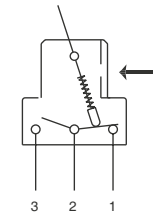

2, 3, and 4 pole

TERMINALS

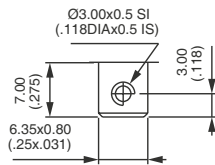

STANDARD PANEL CUT-OUT

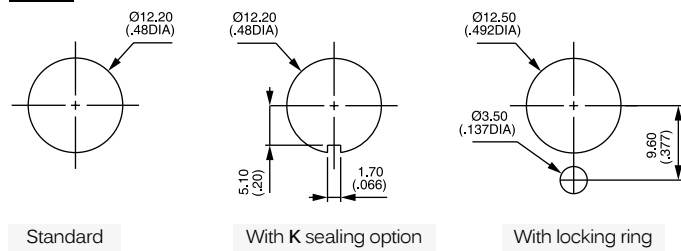

Standard

With K sealing option

With locking ring

PANEL CUT-OUT WITH "K" SEALING

Recommended cut-out and mounting depending on panel thickness

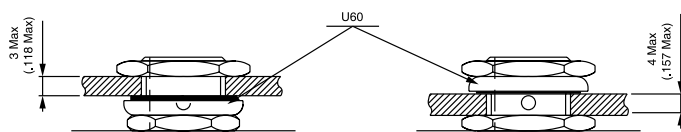

6000 series

Toggle switches for military applications



BUILD YOUR PART NUMBER

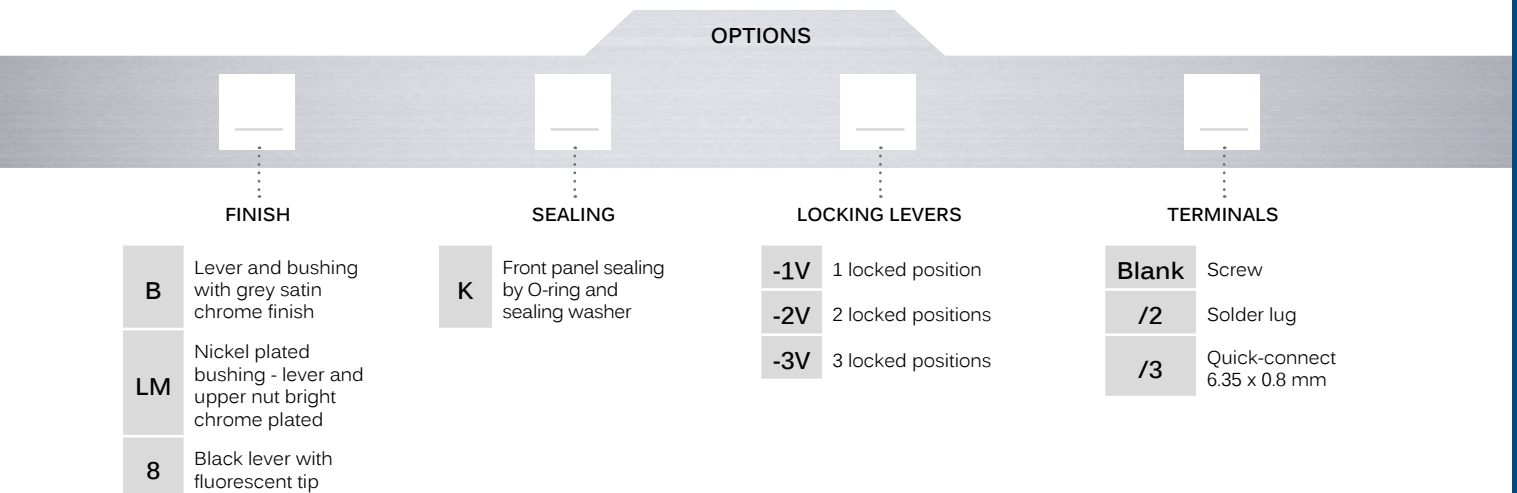
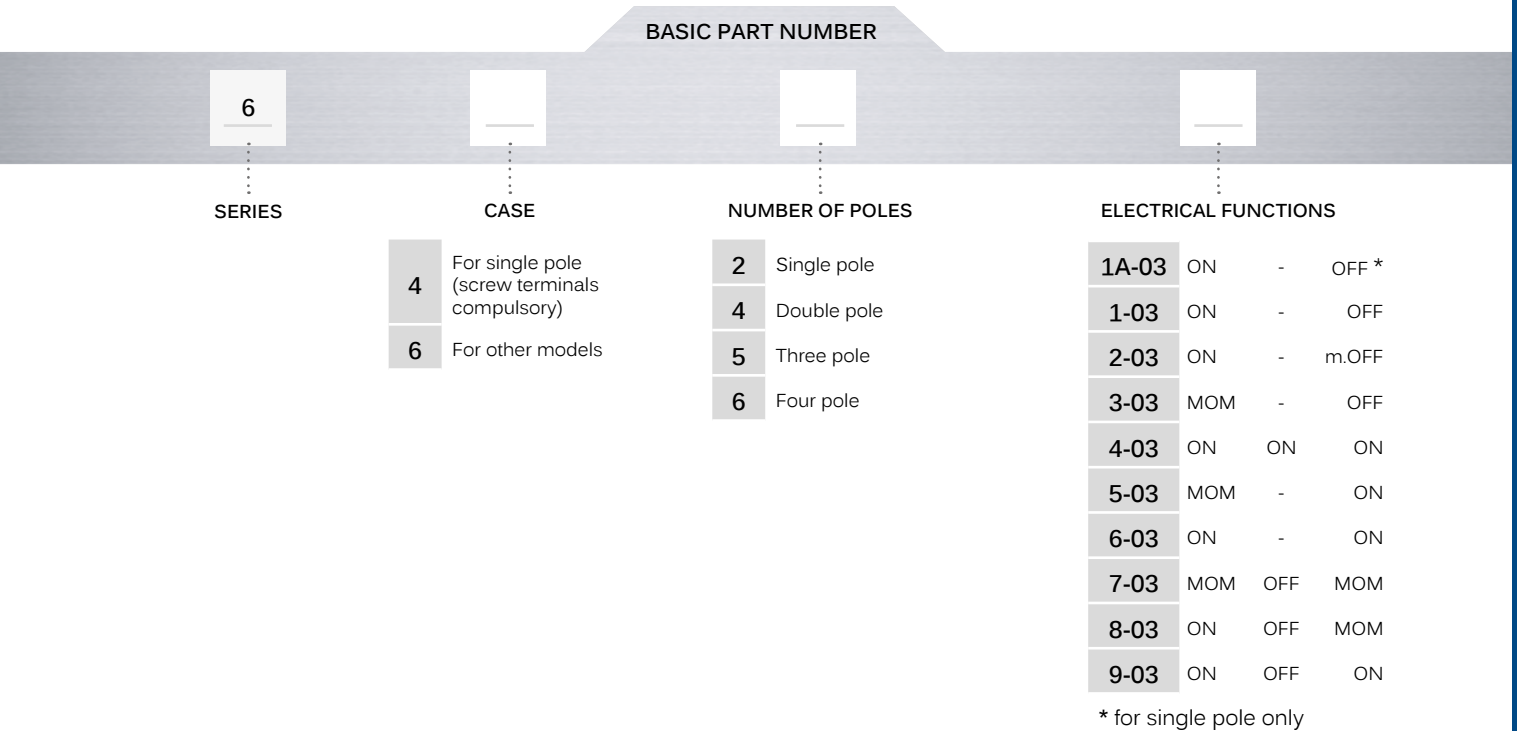

ABOUT THIS SERIES

On the following pages, you will find successively basic part numbers of switches and options in the same order as in above chart.

- ⚠ **Notice** : please note that not all combinations of above numbers are available. Refer to the following pages for further information.
- ⚠ **Sealing boots** are available to protect the switches against dust and water. See "Sealing Boots" section of website.
- ⚠ **Mounting accessories** : standard hardware supplied with all models : 2 matt black nuts U41, matt black locking ring U12, zinc plated lockwasher U13. They are presented in the "Hardware" section of website.

6000 series

Toggle switches for military applications

SCREW TERMINALS - SINGLE POLE



	I	-	II
6421A-03	ON	-	OFF

→ KEYWAY

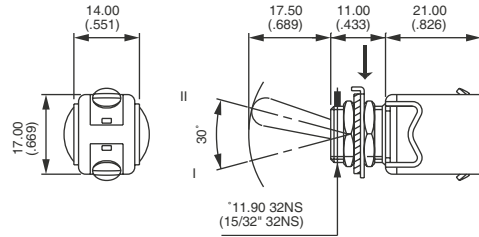

SCREW TERMINALS - DOUBLE POLE



	III	-	II	-	I
	2-1	-	5-4	-	2-3
	5-4	-		-	5-6
6641-03	ON	-		-	OFF
6642-03	ON	-		-	mom.OFF
6643-03	MOM	-		-	OFF
6644-03 ▲	ON	ON		ON	ON
6645-03	MOM	-		-	ON
6646-03	ON	-		-	ON
6647-03	MOM	OFF		-	MOM
6648-03	ON	OFF		-	MOM
6649-03	ON	OFF		-	ON

→ KEYWAY

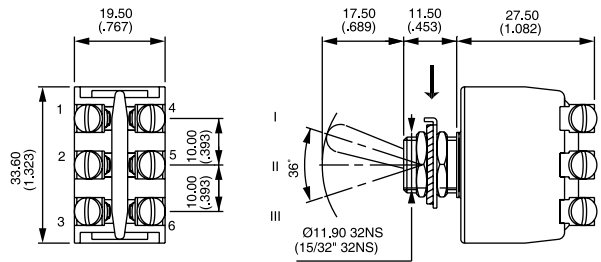

▲ Function 4 : SP in DP case, see "Technical information" on website.

SCREW TERMINALS - THREE POLE



	III*	-	II	-	I**
6651-03	ON	-		-	OFF
6652-03	ON	-		-	mom.OFF
6653-03	MOM	-		-	OFF
6655-03	MOM	-		-	ON
6656-03	ON	-		-	ON
6657-03	MOM	OFF		-	MOM
6658-03	ON	OFF		-	MOM
6659-03	ON	OFF		-	ON

* (2-1) (5-4)(8-7) ** (2-3) (5-6) (8-9)

→ KEYWAY

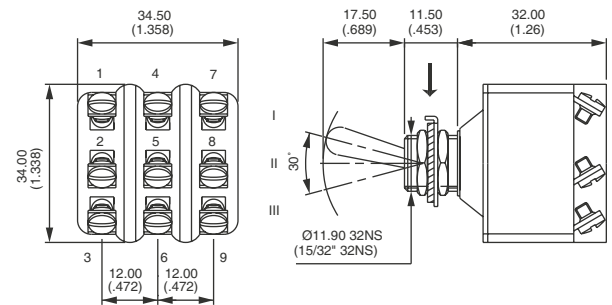

SCREW TERMINALS - FOUR POLE



	III*	-	II	-	I**
6661-03	ON	-		-	OFF
6662-03	ON	-		-	mom.OFF
6663-03	MOM	-		-	OFF
6664-03 ▲	ON	ON		ON	ON
6665-03	MOM	-		-	ON
6666-03	ON	-		-	ON
6667-03	MOM	OFF		-	MOM
6668-03	ON	OFF		-	MOM
6669-03	ON	OFF		-	ON

* (2-1) (5-4)(8-7) (11-10) ** (2-3) (5-6) (8-9) (11-12)

→ KEYWAY

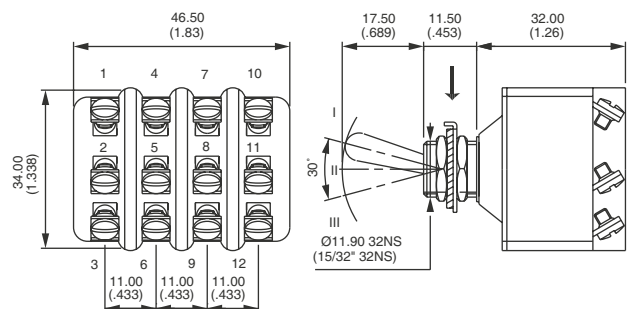

▲ Function 4 : SP in DP case, see "Technical information" on website.

6000 series

Toggle switches for military applications

FINISH

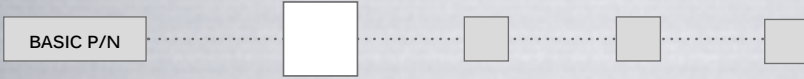

- B** Lever and bushing with grey satin chrome finish
- LM** Nickel plated bushing - lever and upper nut bright chrome plated
- 8** Black lever with fluorescent tip

SEALING

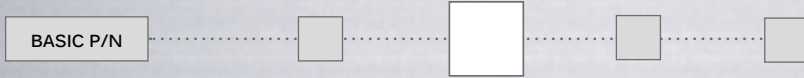

- K** Front sealing by O-ring and sealing washer. Protects the switch against water and dust. Panel seal withstands 1 bar pressure and remains sealed even when switch is operated.

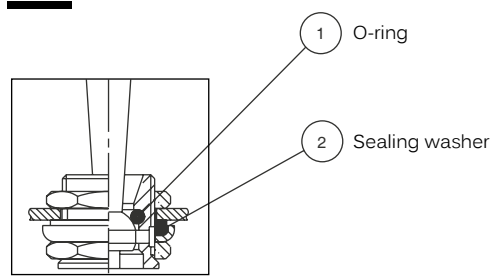

LOCKING LEVERS

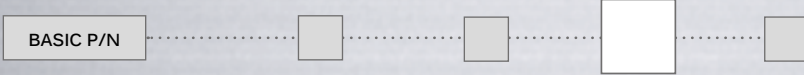

- 1V** 1 locked position
- 2V** 2 locked positions
- 3V** 3 locked positions

→ KEYWAY

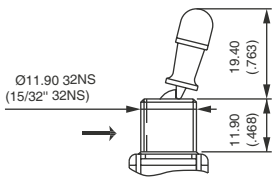

-1V

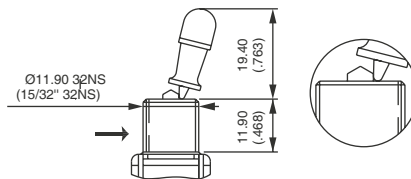

-2V

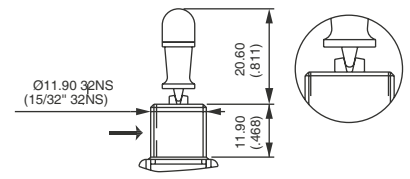

-3V

TERMINALS



- Blank** Screw terminals (compulsory for single pole models)
- /2** Solder lug terminals
- /3** Quick-connect terminals 6.35 x 0.8 (.250 x .031)

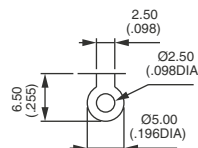

/2

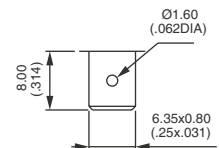

/3

6000 series

Toggle switches for military applications

NEOPRENE PROTECTION CAPS

To be ordered separately.

Example : PROTECTION CAP U58

These caps are designed to insulate terminals against electrical short circuit.

- U58** For 1-pole models
- U120** For 2-pole models
- U46** For 3-pole models
- U47** For 4-pole models

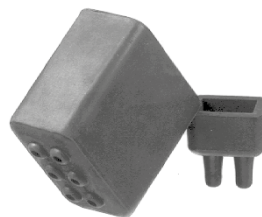

X-ON Electronics

Largest Supplier of Electrical and Electronic Components

Click to view similar products for [Toggle Switches](#) category:

Click to view products by [Apem](#) manufacturer:

Other Similar products are found below :

[8928K478](#) [020017-13](#) [60012L](#) [6006L](#) [CS115W](#) [CS120W](#) [6663](#) [7101SPDV30BE](#) [7103SDV30BE](#) [7105D](#) [7108P3YAV2BE](#) [71YY50282](#)
[7300K36](#) [7301K38](#) [7306K36](#) [7310K36](#) [7506K4](#) [7592K6](#) [7660K12](#) [7691K14](#) [7700K1](#) [8391K108](#) [8396K108](#) [8811K17](#) [8824K14](#) [8828K13](#)
[8835K3](#) [8858K44](#) [PS83-121G](#) [1-1825192-0](#) [A201SCWZB04](#) [A207SYCB04](#) [A208J61ZQ0004](#) [A221T1TCQ](#) [A323S1CWZQ](#)
[A423S1CWZG-M8](#) [1201W](#) [12156AX408](#) [12147AGKX679](#) [12246X778](#) [12TW49-3D](#) [130312](#) [13037L](#) [13001X](#) [AE101MD1W4B04](#)
[AE208SD1W4B04](#) [MS24659-22D](#) [MS27407-5](#) [1520230-9](#) [1520231-1](#)