

# 800 SERIES - SNAP-ACTING MINIATURE PUSHBUTTON SWITCHES

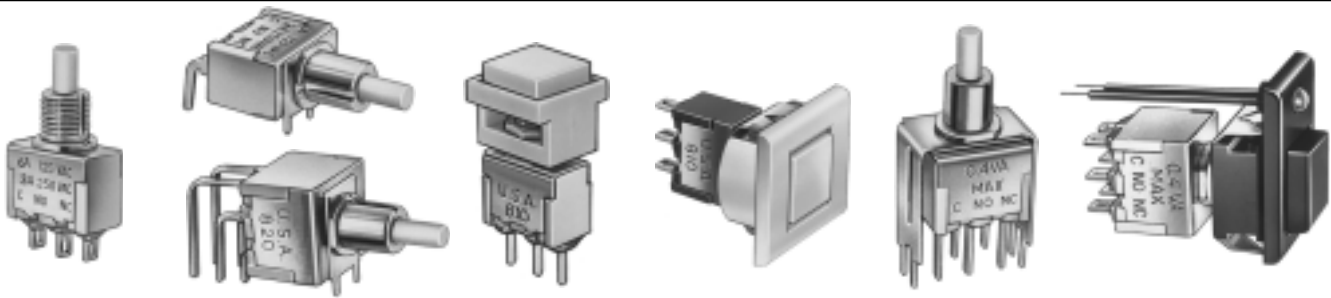

## FEATURES

- Dry circuit through power ratings .
- Ultra-rugged construction SPDT & DPDT momentary models with numerous options.
- Panel, panel & p.c. and p.c. mounting models, lighted and unlighted.

## SPECIFICATIONS

<b>Contact ratings (resistive loads):</b>	(Q) power models - coin silver: 6 Amps at 125 VAC, 3 Amps at 250 VAC or 7 Amps at 30 VDC. (B) dry circuit models - gold over nickel over brass: 0.4 VA max. at 20 V max. UL models - coin silver: 6 Amps at 125 VAC or 3 Amps at 250 VAC (75% power factor). UL file no. E66367. CSA models - coin silver: same ratings as UL models. CSA file no. LR54592-1.
<b>Initial contact resistance:</b>	20 milliohms max. at 3 VDC, 0.1 Amp.
<b>Insulation resistance:</b>	Greater than 200,000 megohms between terminals & case ground.
<b>Dielectric strength:</b>	Greater than 1500 VAC for 1 minute between terminals & case ground.
<b>Electrical life (resistive loads):</b>	60,000 cycles min. at full load.
<b>Operating temperature range:</b>	-30°C to +85°C
<b>Total travel:</b>	.035" (0.9mm) approx.
<b>Actuation force:</b>	Single pole: 290 ± 75 grams    Double pole: 550 ± 75 grams

Also see economy ratings  
N & T in options section.

## MATERIALS

<b>Contacts:</b>	Coin silver for power, UL & CSA models. Gold over nickel over brass for dry circuit models.
<b>Actuator:</b>	Glass filled polyester, color white
<b>Bushing:</b>	Nickel plated brass
<b>Strap:</b>	Stainless steel
<b>Case:</b>	DAP, color blue
<b>Terminal seal:</b>	Epoxy (standard)
<b>Support bracket:</b>	Brass or steel, tin plated
<b>Spring mounting bracket:</b>	Stainless steel
<b>Bezel &amp; cap:</b>	Nylon. Available in black, red & white. Consult factory for other colors.
<b>Hardware:</b>	See 'Miscellaneous' section.
<b>LED:</b>	Intensity: 2.0 mcd at 10 mA. Forward voltage: 2.0V (3.0V max.). Max. continuous forward current: 15 mA for red, 30 mA for green & 20 mA for yellow. Red is standard. Yellow & green are optional. Specifications are subject to change without notice - consult factory.

**AGENCY RECOGNITION** UL, & CSA. Marking: Switches ordered with '/UL' added at end of model no. are supplied with recognition marked. Switches ordered with '/CSA' added at end of model no. are supplied with recognition marked.



## ABOUT THIS SERIES

The material in this series is organized in the following sequence:

- Completely specified switch models
- 'build your own switch' order format
- Miscellaneous
- Option drawings & information
- Panel cut-outs

# 800 SERIES - SNAP-ACTING MINIATURE PUSHBUTTON SWITCHES

## Solder lug terminals - panel mounting

### SINGLE POLE

POWER CKT. MODEL NO.	UL MODEL NO.
810KMZQ	810KMZQ/UL

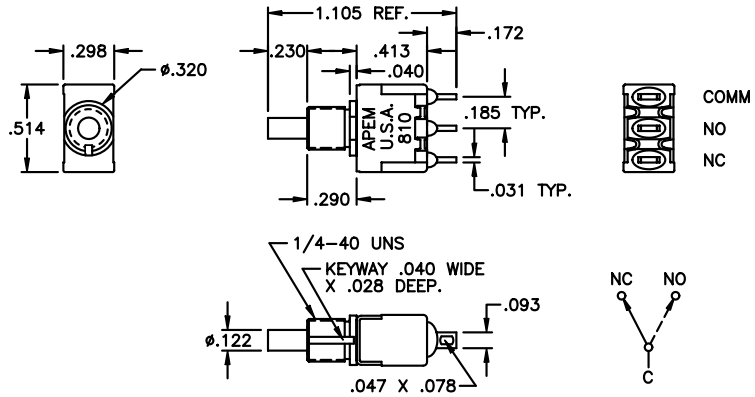

### DOUBLE POLE

POWER CKT. MODEL NO.	UL MODEL NO.
820KMZQ	820KMZQ/UL

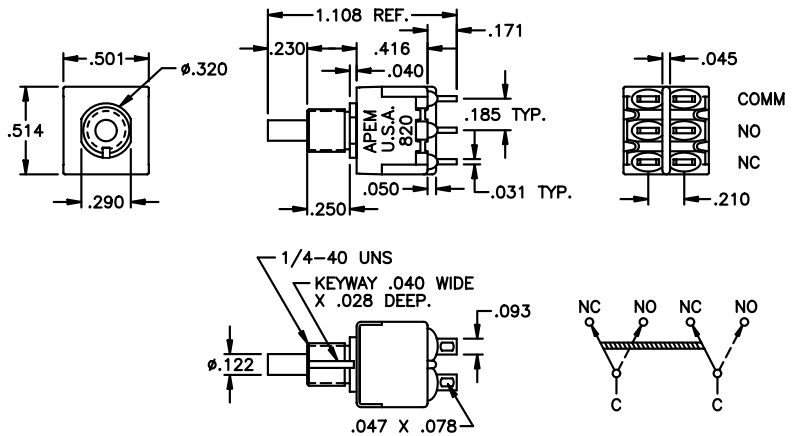

## Horizontal right angle p.c. terminals - p.c. mounting

### SINGLE POLE

DRY CKT. MODEL NO.	UL MODEL NO.
810KSAB	810KSAQ/UL
810KSA-1B	810KSA-1Q/UL

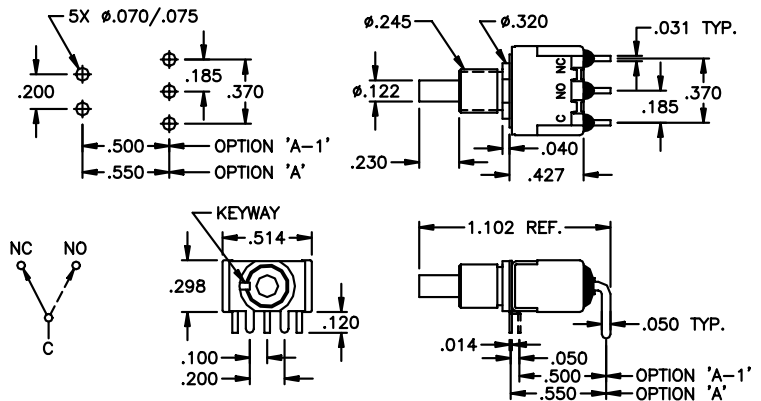

### DOUBLE POLE

DRY CKT. MODEL NO.	UL MODEL NO.
820KSAB	820KSAQ/UL
820KSA-1B	820KSA-1Q/UL

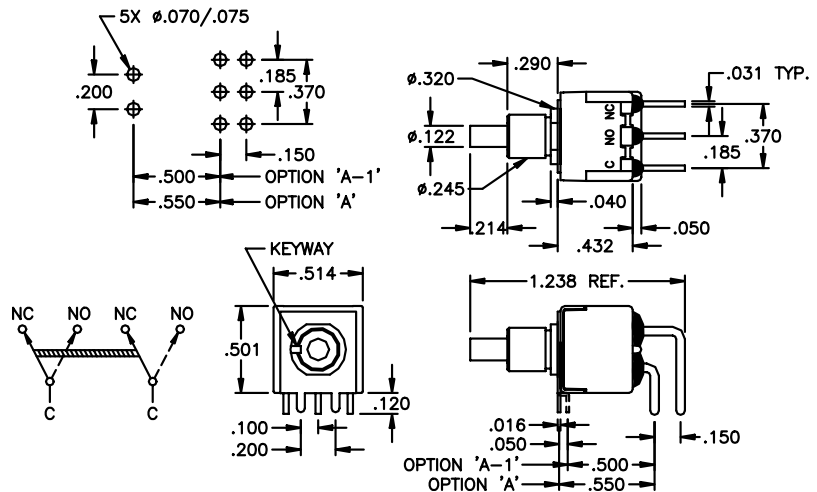
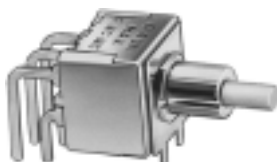

SPECIFICATIONS SUBJECT TO CHANGE WITHOUT NOTICE

# 800 SERIES - SNAP-ACTING MINIATURE PUSHBUTTON SWITCHES

## Vertical right angle p.c. terminals - p.c. mounting

### SINGLE POLE

DRY CKT. MODEL NO.	UL MODEL NO.
810KSVB	810KSVQ/UL
810KSV-1B	810KSV-1Q/UL
810KSV-2B	810KSV-2Q/UL

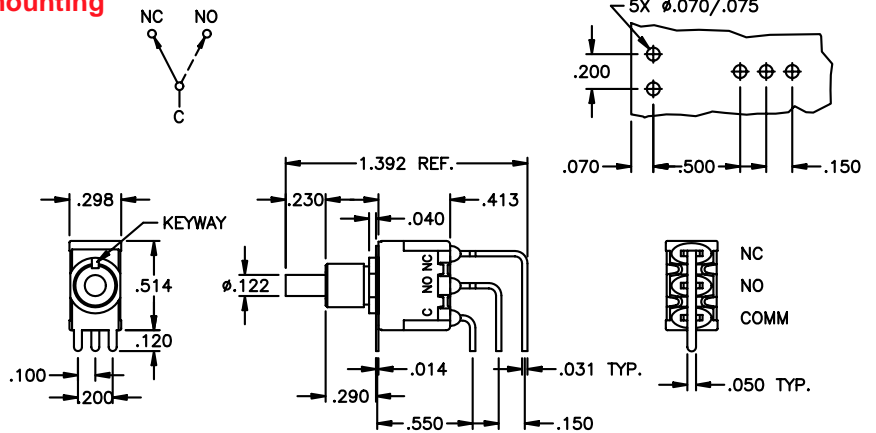

### DOUBLE POLE

DRY CKT. MODEL NO.	UL MODEL NO.
820KSVB	820KSVQ/UL
820KSV-1B	820KSV-1Q/UL
820KSV-2B	820KSV-2 Q/UL

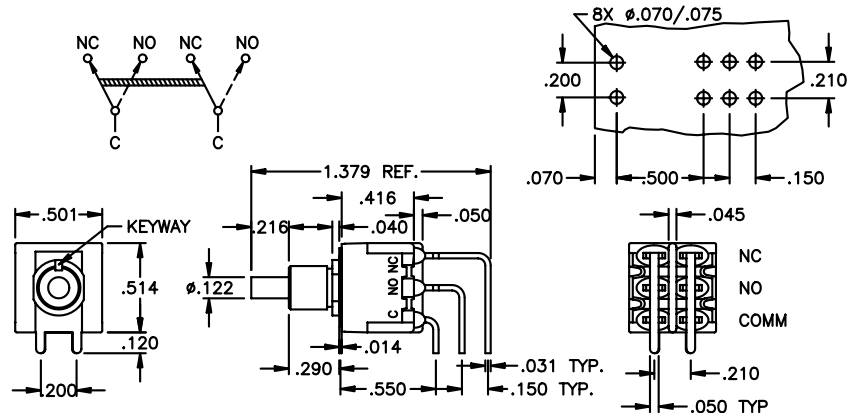

## Straight p.c. terminals with bracket

### SINGLE POLE

DRY CKT. MODEL NO.	UL MODEL NO.
810KSV30B	810KSV30Q/UL
810KSV40B	810KSV40Q/UL

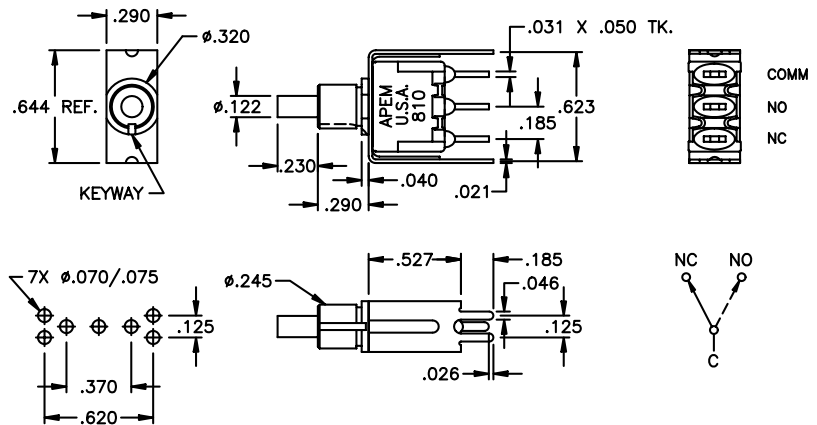

### DOUBLE POLE

DRY CKT. MODEL NO.	UL MODEL NO.
820KSV30B	820KSV30Q/UL
820KSV40B	820KSV40Q/UL

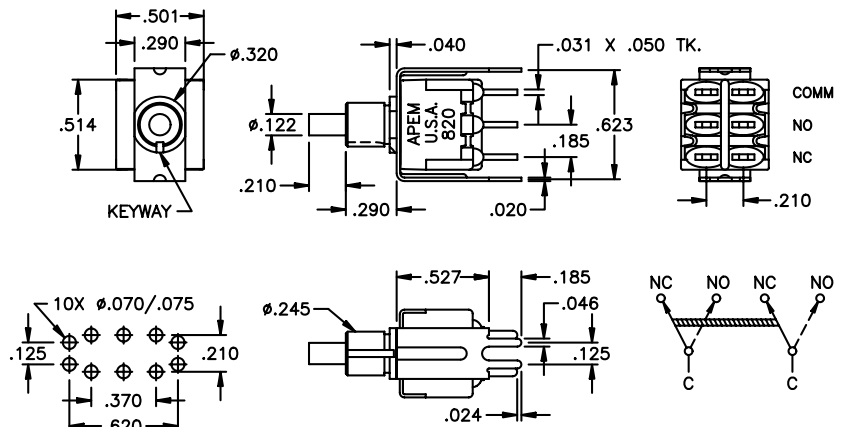

SPECIFICATIONS SUBJECT TO CHANGE WITHOUT NOTICE



# 800 SERIES - SNAP-ACTING MINIATURE PUSHBUTTON SWITCHES

## Solder lug terminals - snap-in bezel with outboard LED

### SINGLE POLE

POWER CKT. MODEL NO.	UL MODEL NO.	DIM. A
810K2M1ZQJ6122	810K2M1ZQJ6122/UL	.100
810K1M1ZQJ6122	810K1M1ZQJ6122/UL	.010

Models listed above have black bezel and cap.

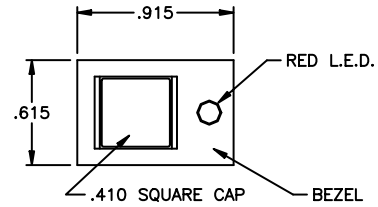
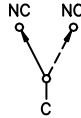

### DOUBLE POLE

POWER CKT. MODEL NO.	UL MODEL NO.	DIM. A
820K2M1ZQJ6122	820K2M1ZQJ6122/UL	.100
820K1M1ZQJ6122	820K1M1ZQJ6122/UL	.010

Models listed above have black bezel and cap.

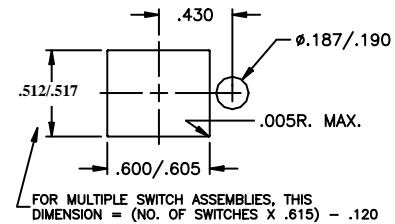
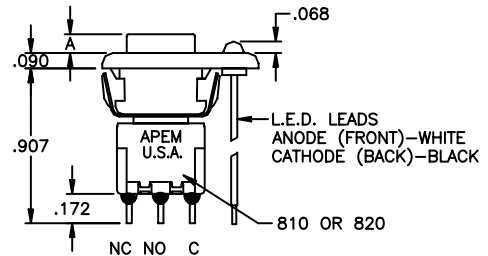
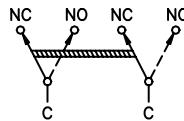

## Solder lug terminals - snap-in bezel

### SINGLE POLE

POWER CKT. MODEL NO.	UL MODEL NO.	DIM. A
810K2M1ZQJ8122	810K2M1ZQJ8122/UL	.100
810K1M1ZQJ8122	810K1M1ZQJ8122/UL	.010

Models listed above have black bezel and cap.

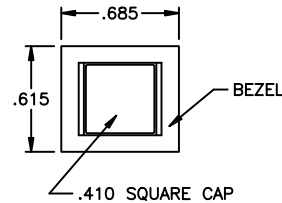

### DOUBLE POLE

POWER CKT. MODEL NO.	UL MODEL NO.	DIM. A
820K2M1ZQJ8122	820K2M1ZQJ8122/UL	.100
820K1M1ZQJ8122	820K1M1ZQJ8122/UL	.010

Models listed above have black bezel and cap.

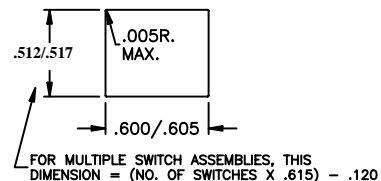
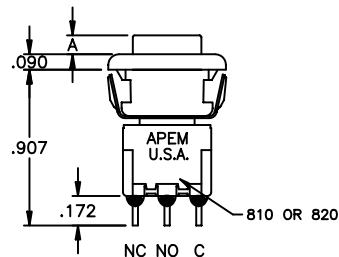
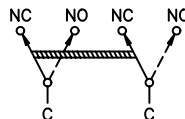

SPECIFICATIONS SUBJECT TO CHANGE WITHOUT NOTICE

# 800 SERIES - SNAP-ACTING MINIATURE PUSHBUTTON SWITCHES

## Straight p.c. terminals - p.c. mounting bezel

### SINGLE POLE

DRY CKT. MODEL NO.	UL MODEL NO.	DIM. A
810K2M1CBJ8422	810K2M1CQJ8422/UL	.100
810K1M1CBJ8422	810K1M1CQJ8422/UL	.010

### DOUBLE POLE

DRY CKT. MODEL NO.	UL MODEL NO.	DIM. A
820K2M1CBJ8422	820K2M1CQJ8422/UL	.100
820K1M1CBJ8422	820K1M1CQJ8422/UL	.010

Models listed above have black bezel and cap.

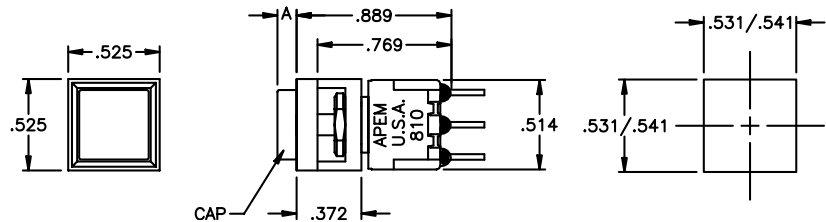
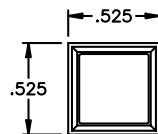
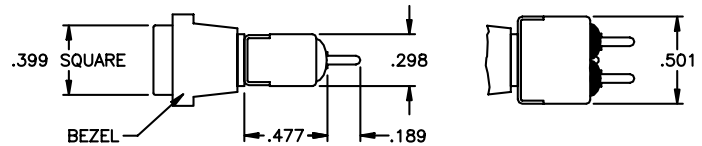
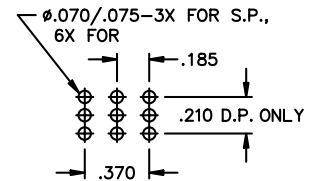
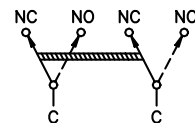

## Straight p.c. terminals w/bracket - p.c. mounting bezel

### SINGLE POLE

DRY CKT. MODEL NO.	UL MODEL NO.	DIM. A
810K2M1V30BJ8422	810K2M1V30QJ8422/UL	.100
810K1M1V30BJ8422	810K1M1V30QJ8422/UL	.010

### DOUBLE POLE

DRY CKT. MODEL NO.	UL MODEL NO.	DIM. A
820K2M1V30BJ8422	820K2M1V30QJ8422/UL	.100
820K1M1V30BJ8422	820K1M1V30QJ8422/UL	.010

Models listed above have black bezel and cap.

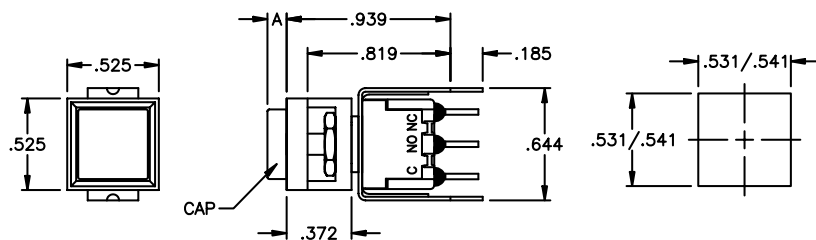
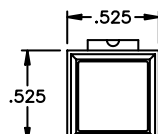
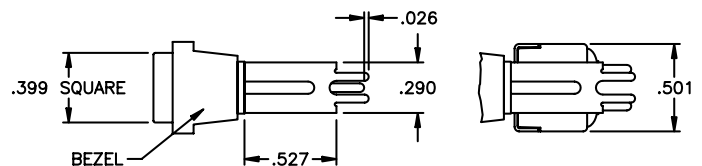
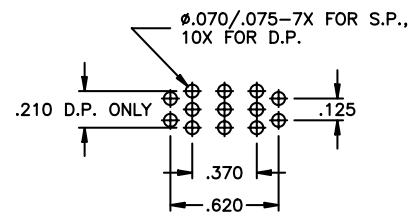
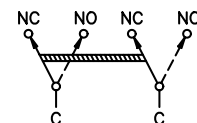
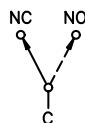

SPECIFICATIONS SUBJECT TO CHANGE WITHOUT NOTICE

L

# 800 SERIES - SNAP-ACTING MINIATURE PUSHBUTTON SWITCHES

## Horizontal right angle p.c. terminals - p.c. mounting bezel

### SINGLE POLE

DRY CKT. MODEL NO.	UL MODEL NO.	DIM. A
810K2M1ABJ8422	810K2M1AQJ8422/UL	.100
810K1M1ABJ8422	810K1M1AQJ8422/UL	.010

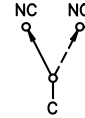
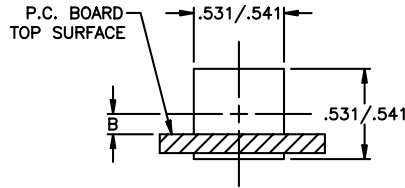

### DOUBLE POLE

DRY CKT. MODEL NO.	UL MODEL NO.	DIM. A
820K2M1ABJ8422	820K2M1AQJ8422/UL	.100
820K1M1ABJ8422	820K1M1AQJ8422/UL	.010

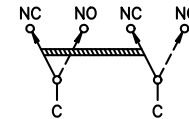
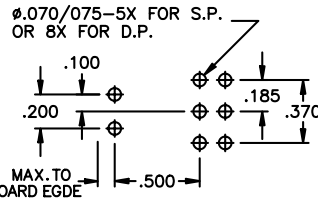

Models listed above have black bezel and cap.

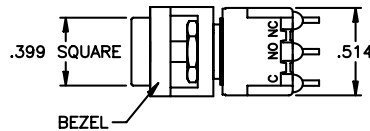

Poles	Option	Dim. B	Dim. C
SP	A	.148	.045 max.
SP	A-1	.164	.095 max.
DP	A	.250	.300 max.
DP	A-1	.266	.350 max.

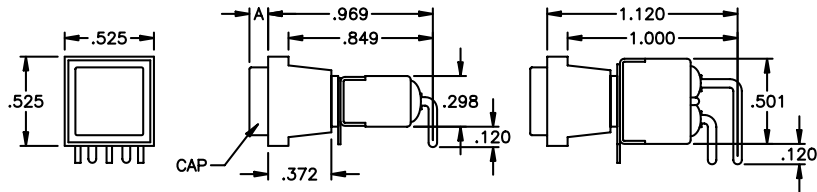

## Vertical right angle p.c. terminals - p.c. mounting bezel

### SINGLE POLE

DRY CKT. MODEL NO.	UL MODEL NO.	DIM. A
810K2M1V-1BJ8422	810K2M1V-1QJ8422/UL	.100
810K1M1V-1BJ8422	810K1M1V-1QJ8422/UL	.010

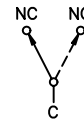
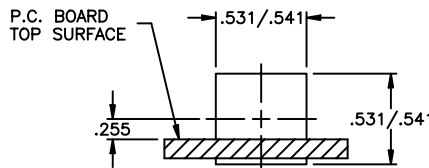

### DOUBLE POLE

DRY CKT. MODEL NO.	UL MODEL NO.	DIM. A
820K2M1V-1BJ8422	820K2M1V-1QJ8422/UL	.100
820K1M1V-1BJ8422	820K1M1V-1QJ8422/UL	.010

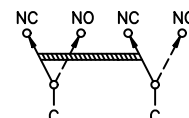
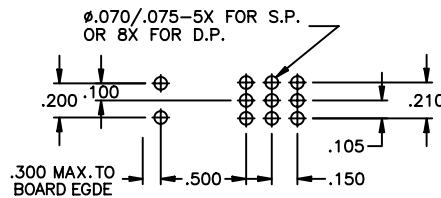

Models listed above have black bezel and cap.

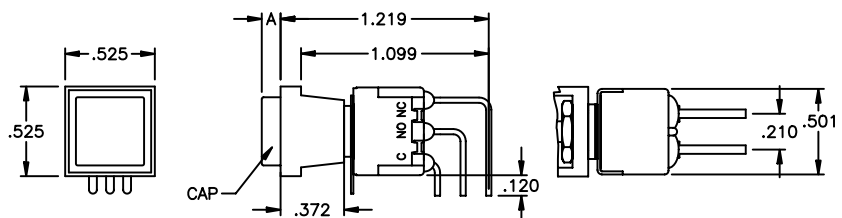
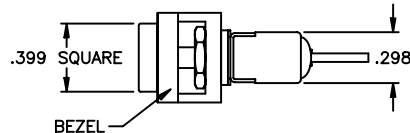
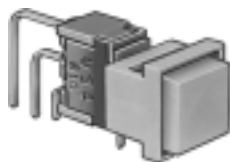

SPECIFICATIONS SUBJECT TO CHANGE WITHOUT NOTICE

# 800 SERIES - SNAP-ACTING MINIATURE PUSHBUTTON SWITCHES

## Snap-in bezel for round hole mounting

Self-keying against rotation

### SINGLE POLE

POWER CKT. MODEL NO.	UL MODEL NO.	DIM. A
810K2M1ZQJ9622	810K2M1ZQJ9622/UL	.100
810K1M1ZQJ9622	810K1M1ZQJ9622/UL	.010

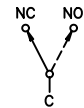
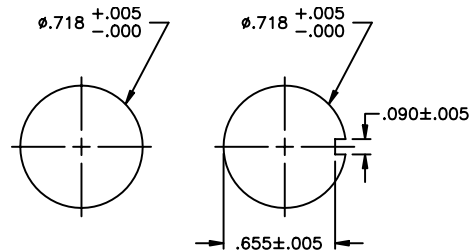

### DOUBLE POLE

POWER CKT. MODEL NO.	UL MODEL NO.	DIM. A
820K2M1ZQJ9622	820K2M1ZQJ9622/UL	.100
820K1M1ZQJ9622	820K1M1ZQJ9622/UL	.010

Models listed above have black bezel and cap.

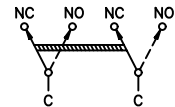
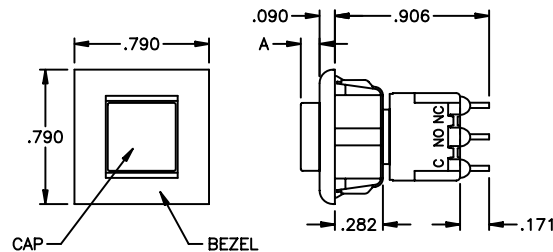
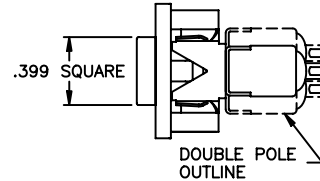

SPECIFICATIONS SUBJECT TO CHANGE WITHOUT NOTICE



**Additional ordering information:** Commonly ordered models are shown above and on prior pages with complete model numbers and specifications. Below is an order format that enables you to 'build your own switch' and specify the correct switch model number by simply selecting from all available options shown and filling in the boxes.

## 'BUILD YOUR OWN SWITCH' ORDER FORMAT

Fill in boxes with selections shown for **Model Structure**, then add **Options** selections for complete model number. Allowable options are shown below each respective box with brief description - see option dwgs. & info. following.

Note: 'NONE' indicates box may be left empty.

### Model Structure:

Series	Actuators	Bushings	Terminations	Contact materials
<input type="text"/>	<input type="text"/>	<input type="text"/>	<input type="text"/>	<input type="text"/>
Single pole: 8 1 0	K Standard K 1 Short	M Standard 1/4" thd'd. M 1 Short 1/4" thd'd.	Z Solder lug C Printed circuit	B Gold Q Coin silver
Double pole: 8 2 0	K 2 Medium	D 1/4" thd'd. w/'D' flat S Non-threaded	W Wirewrap W 1 Lg. wirewrap W 3 Sht. wirewrap X Extra lg. wirewrap	G Gold over coin silver N Economy gold T Economy silver

Notes:  
When bezel is specified and flush cap is desired, specify K1 actuator and M1 bushing.  
When bezel is specified and raised cap is desired, specify K2 actuator and M1 bushing.  
Epoxy terminal seal is standard on 800 Series.

### Options:

Bezel& cap	Bezel color	Cap color	Approvals
<input type="text"/>	<input type="text"/>	<input type="text"/>	<input type="text"/>
(NONE) J 6 1 Snap-in w/LED J 8 1 Snap-in no LED J 8 4 P.C. style J 9 6 Snap-in (round hole)	(NONE) 2 Black 6 Red 8 White Consult factory for other colors.	(NONE) 2 Black 6 Red 8 White	(NONE) / U L / C S A

Although most combinations of options are available, some may result in incompatibilities. Consult factory if there is any question.

Horiz. right angle p.c. terminals:  
A  
A - 1  
Vertical right angle p.c. terminals:  
V  
V - 1  
V - 2  
Straight p.c. terminals w/brkt.:  
V 3 0  
V 4 0

Example of completely specified model number:  
**820K1M1ZQJ8126/UL/CSA**



# 800 SERIES - SNAP-ACTING MINIATURE PUSHBUTTON SWITCHES

## MISCELLANEOUS

**TYPICAL  
SWITCH  
CROSS  
SECTION**

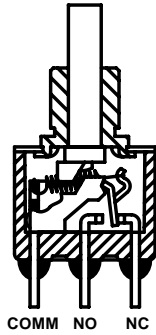

### HARDWARE SUPPLIED

(See Hardware section of catalog)

Switches with M option bushings are supplied with (2) A112 Hex Nuts, (1) A115 Lockwasher and (1) A107 Anti-rotate Ring.

Switches with D option bushings are supplied with (2) A112 Hex Nuts and (1) A115 Lockwasher.

Switches with M1 option bushings are supplied with (1) A112 Hex Nut and (1) A115 Lockwasher.

Note: Switches with non-threaded bushings or bezels supplied without hardware.

**SWITCH BODY  
SIZES WITH  
TERMINAL  
LOCATION  
DIMENSIONS**

SIDE VIEW  
SINGLE POLE

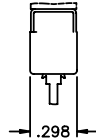

SIDE VIEW  
DOUBLE POLE

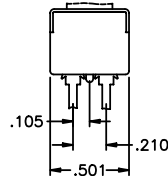

FRONT VIEW  
SINGLE AND  
DOUBLE POLE

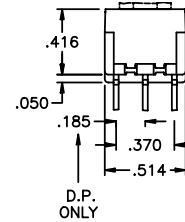

## BUSHING OPTIONS

**NOTE:  
BUSHING M AND  
ACTUATOR K  
ARE STANDARD.**

### M & M1

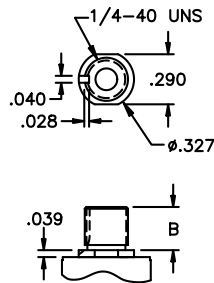

THREADED

### D

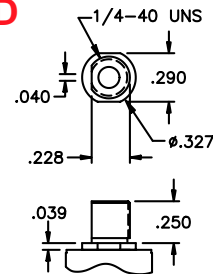

THREADED

### S

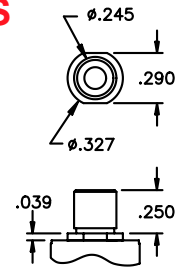

NON-THREADED

## ACTUATOR/BUSHING OPTIONS

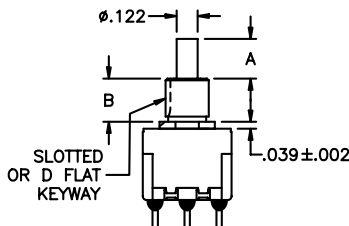

BUSHING OPTION	DIM. B	DIMENSION A ACTUATOR OPTION		
		K	K1	K2
M or D	.250	.230	.069	.168
S	.250	.230	.069	.168
M1	.154	.322	.165	.264

All bushings have 1/4-40 UNS-2A thread except S which is non-threaded.

Switch caps for switches without bezels also available - see Hardware section of catalog.

SPECIFICATIONS SUBJECT TO CHANGE WITHOUT NOTICE



# 800 SERIES - SNAP-ACTING MINIATURE PUSHBUTTON SWITCHES

## TERMINATION OPTIONS

**A**

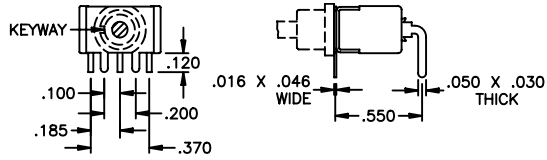

SINGLE POLE HORIZONTAL P.C. MOUNTING

**A-1**

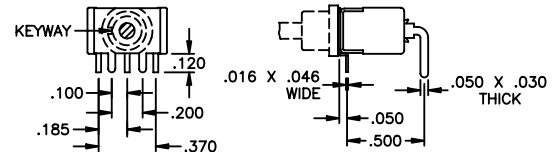

SINGLE POLE HORIZONTAL P.C. MOUNTING

**A**

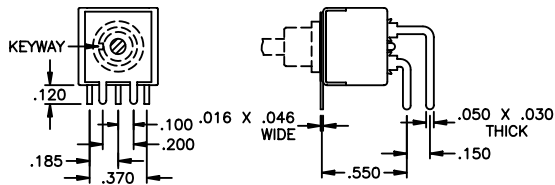

DOUBLE POLE HORIZONTAL P.C. MOUNTING

**A-1**

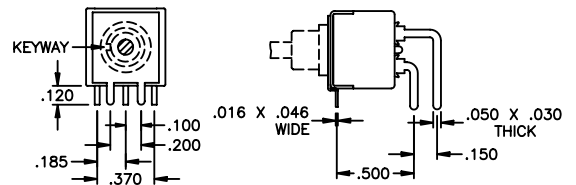

DOUBLE POLE HORIZONTAL P.C. MOUNTING

## V, V-1 & V-2

FRONT VIEW SINGLE POLE

FRONT VIEW DOUBLE POLE

SIDE VIEW - SINGLE & DOUBLE POLE

Option	Dim. A	Dim. B
V	.550	.150
V-1	.500	.150
V-2	.500	.100

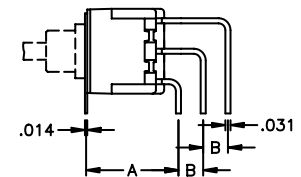
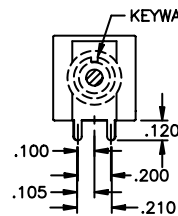
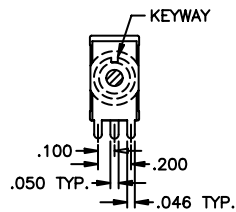

VERTICAL P.C. MOUNTING

## V30 & V40

PANEL LAYOUT V30 & V40

Option	Dim. A	Dim. B
V30	.527	.024
V40	.647	.048

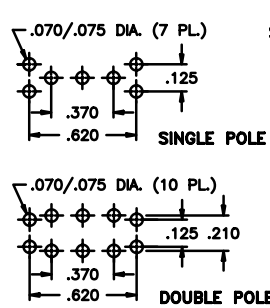

FRONT VIEW SINGLE POLE

FRONT VIEW DOUBLE POLE

SIDE VIEW - SINGLE AND DOUBLE POLE

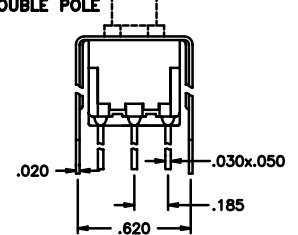
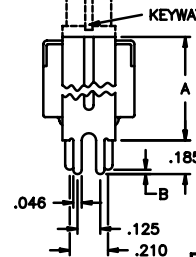
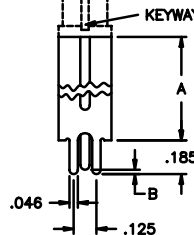

PRINTED CIRCUIT MOUNTING

SPECIFICATIONS SUBJECT TO CHANGE WITHOUT NOTICE

L

# 800 SERIES - SNAP-ACTING MINIATURE PUSHBUTTON SWITCHES

## TERMINATION OPTIONS (CONT'D.)

Z	C	W	W1	W3	X
SOLDER LUG	PRINTED CIRCUIT	WIREFRAP	LONG WIREFRAP	SHORT WIREFRAP	EXTRA LG. WIREFRAP

## CONTACT MATERIAL OPTIONS

<b>B</b>	Dry circuit - gold over nickel over brass. RATING: 0.4 Volt-Amps (VA) max. at 20 V max. ELECTRIC LIFE: 60,000 cycles minimum. MECHANICAL LIFE: 500,000 cycles minimum.	
<b>Q</b>	Power circuit - coin silver. RATING: 6 Amps at 125 VAC, 3 Amps at 250 VAC or 7 Amps at 30 VDC (resistive loads). ELECTRIC LIFE: 60,000 cycles minimum at full load.	
<b>G</b>	Dry circuit or power circuit - gold over nickel over coin silver. RATINGS & ELECTRIC LIFE: Same as B & Q above - i.e. - can be used in either dry circuit or power circuit, however once used in power circuit, switch cannot be re-used in dry circuit. This option satisfies those customers who have both dry circuit and power circuit requirements, but prefer to inventory only one switch for both.	
<b>N</b>	Dry circuit - gold over nickel over brass. Note- less gold than B option. RATING: 0.4 Volt-Amps (VA) max. at 20 V max. ELECTRIC LIFE: 10,000 cycles min. at 13 cycles per minute.	
<b>T</b>	Power circuit - Silver plate over brass. RATING: 1 Amp at 125 VAC or 0.5 Amps at 250 VAC (resistive loads). ELECTRIC LIFE: 10,000 cycles min. at 13 cycles per minute.	Solder dipped terminals and custom contact plating available - contact factory.

## UL & CSA OPTIONS

<b>UL</b>	For power circuits - coin silver RATING: 6 Amps at 125 VAC or 3 Amps at 250 VAC (75% power factor). Underwriter Laboratories file no. E66367. Note - applicable only to terminations with coin silver contacts (Q or G options).
<b>CSA</b>	For power circuits - coin silver RATING: 6 Amps at 125 VAC or 3 Amps at 250 VAC (75% power factor). Canadian Standards Association file no. LR54592-1. Note - applicable only to terminations with coin silver contacts (Q or G options) as CSA recognizes switches for power applications only.

## PANEL CUT-OUTS

### Cut-outs that accept all 1/4-40 threaded bushings:

Without keying	With A107 anti-rotate ring	With A158 anti-rotate ring	With D bushing	With slotted keyway bushings	Accepts all 1/4" non-threaded bushings

SPECIFICATIONS SUBJECT TO CHANGE WITHOUT NOTICE

## X-ON Electronics

Largest Supplier of Electrical and Electronic Components

*Click to view similar products for [Pushbutton Switches](#) category:*

*Click to view products by [Apem](#) manufacturer:*

Other Similar products are found below :

[8940K2012](#) [LW1L-M1C10V-A](#) [LW1L-M1C70-A](#) [LW2L-A1C20M-GD](#) [LW2L-M1C20M-A](#) [60324L](#) [M22-D-R-GB0/K11](#) [M7E-HRN2](#)  
[67021K512](#) [67081K512X](#) [701PB580](#) [7190K101](#) [7199K101](#) [810K12910](#) [810KSV30B](#) [MML21EA2ADK](#) [MML21KA3ABK](#)  
[MML23KA3AC05K-001](#) [MML23KW3AA01W](#) [8418K2](#) [8442K3](#) [8450K1](#) [860K11911T01A](#) [861901](#) [861K11911T01A07](#)  
[861K13810T00A14](#) [861K13911](#) [8646AB6X718UL](#) [8646ABUL](#) [9001KXRK](#) [907AYY100](#) [PMHD155A1](#) [95-313.000](#)  
[9533CD4+U574+U4922](#) [95-414.000](#) [99-450.837](#) [99-453.837](#) [PV3H2B0NN-341](#) [1203MRA](#) [A22NZBGANGA](#) [A22NZBMMNGA](#)  
[A22NZBNANGA](#) [A22NZMPATRA](#) [A2PMA1X03EC56](#) [A3A-5123-02](#) [A3A-7140](#) [A3A-7310](#) [A3A-7340](#) [A3U-TMW-A2C-5M](#) [A595](#)