

# AV series

## Anti-vandal and security pushbutton switches

### Distinctive features

- ❑ **Attractive, robust and durable**
  - Irremovable
  - Anti-jamming construction : reduced travel to prevent insertion of foreign parts
  - Contact and mechanism protected against crushing
  - Fire resistant
  - Long life
- ❑ **Different bushing sizes and actuator shapes**
- ❑ **Sealed versions**
- ❑ **Degree of protection of sealed versions (switches mounted on vertical panels) : IP65 to IP67 or IP69K depending on models**
- ❑ **UL/CSA approved models**

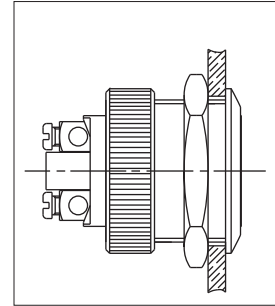

The AV series is a large range of very robust pushbutton switches, consisting of 2 families :

#### ANTI-VANDAL PUSHBUTTON SWITCHES (pages 77-79)

- Great robustness (impact resistance IK08 (Ø 19 mm) and IK10 (Ø 22 mm))
- Actuator and bushing : stainless steel
- Bushing Ø 19 mm (.748) or 22 mm (.866)

#### SECURITY PUSHBUTTON SWITCHES (pages 80-106)

- Large variety of models
- Actuator and bushing : nickel plated, chrome plated or polished varnished brass, stainless steel
- Bushing diameter 16 mm (.629), 19 mm (.748), 22 mm (.866) or 24 mm (.944)
- Marking, illumination, tactile feedback
- Numerous electrical functions (momentary or maintained)

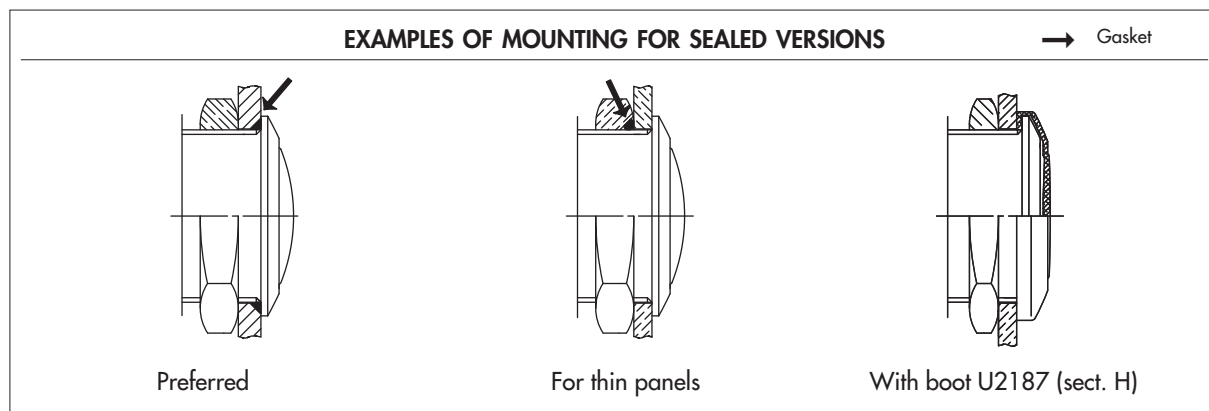

**Dimensions** : first dimensions are in mm while inches are shown as bracketed numbers.



**Packaging unit** : specified on the following pages.



**Mounting accessories** : Standard and special hardware are presented in section I.



**Sealing boots** are available for models with Ø 19 mm (.748) bushing. See Section H.

# AV series

## Anti-vandal pushbutton switches

*Distinctive features and specifications*

- Very robust**  
Impact resistance IK08 for model Ø 19 mm (.748)  
and IK10 for model Ø 22 mm (.866)
- Stainless steel actuator and bushing**
- UL-CSA approved (long case only)**

### SPECIFICATIONS

- Max. current/voltage rating with resistive load :
  - A contacts : 4A 12VDC, 500.000 cycles
  - C contacts : 2A 48 VDC, 10.000 cycles
- Initial contact resistance : 10 mΩ max.
- Insulation resistance : 1.000 MΩ min. at 500VDC
- Dielectric strength : 2.000 Vrms 50 Hz min. between terminals and frame  
2.000 Vrms 50 Hz min. between terminals
- Torque : 5 Nm min.- 14 Nm max. applied to nut
- Panel thickness : 1 (.039) to 11 mm (.433) max.
- Operating temperature : -30°C to +70°C
- Low level or mechanical life : 1.000.000 cycles
- Hand soldering : 300°C, 3 sec. max.
- Packaging unit : 20 pieces (models Ø 22) or 40 pieces (models Ø 19)

### MATERIALS

- Case : PBT
- Contacts : silver (A)  
or brass, silver plated (C)
- Bushing : stainless steel
- Actuator : stainless steel

### CUT-OUT

- Panel cut-out :  
Ø 19,2 mm (.755)  
or Ø 22,2 mm (.874)
- Min. pitch for matrix mounting :  
30 mm x 30 mm (1.181x1.181)

### ROBUSTNESS

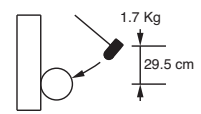
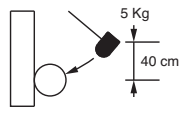
	Model Ø 19 mm (.748)		Model Ø 22 mm (.866)	
Degree of protection according to EN 50102, June 95 (NFC 20-015)		<b>IK08</b> Striking energy: 5 joules (5Nm)		<b>IK10</b> Striking energy: 20 joules (20Nm)
	Hammer radius 25 mm		Hammer radius 50 mm	

Increased impact resistance provided by a nut or mechanical stop.

### SEALING ( OPTION T )

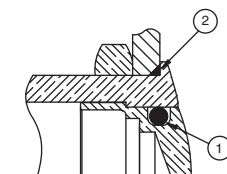

Front panel sealing (IP65)

① internal gasket ② external gasket

Option N does not include ① nor ②.

B2

# AV series

Anti-vandal pushbutton switches Ø 19 mm (.748)

Momentary (NO)

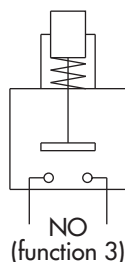

## ORDER FORMAT

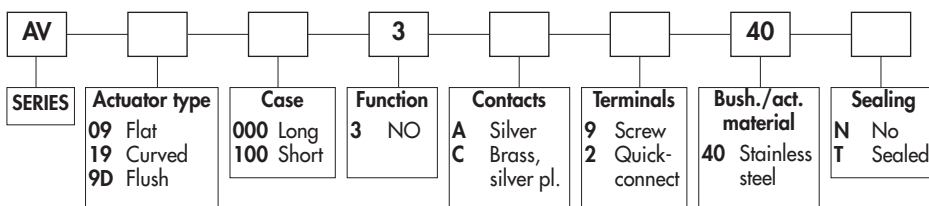

B2

In the following model numbers, replace • with elements selected in the above order format.

### Flat actuator - short case - 48VDC - AV09100



Screw terminals  
AV091003•940•



Solder lug / quick-connect term.  
AV091003•240•



Screw terminals for wires 1,5 mm<sup>2</sup> max.

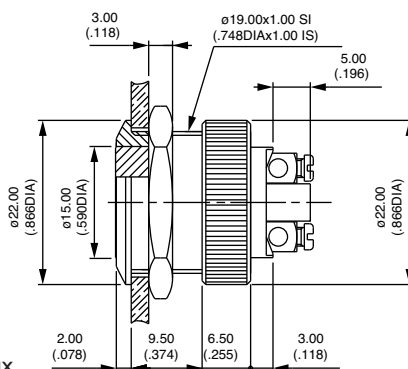

Hex nut 22 (.866) across flats

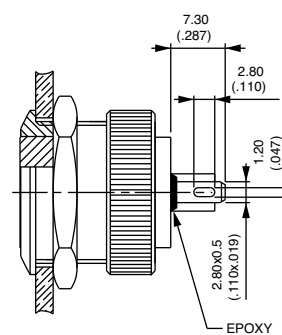

### Flat actuator - long case - 4A 250VAC/8A125VAC - UL/CSA - AV09000



Screw terminals  
AV090003A940•



To order switches marked UL-CSA, add "UU" at the end of model number.

Screw terminals for wires 1,5 mm<sup>2</sup> max.

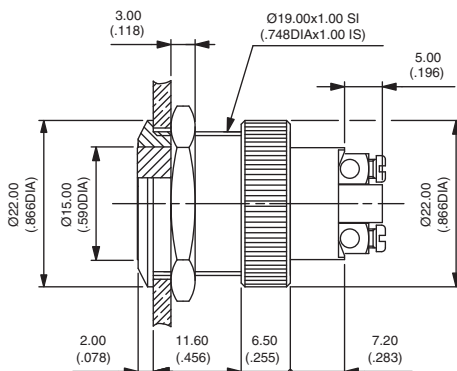

Hex nut 22 (.866) across flats

### Curved actuator - AV19

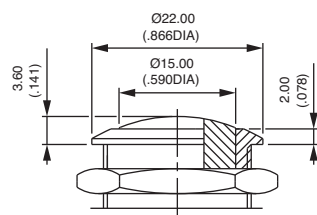

Screw terminals  
AV19•003•940•  
Solder lug/quick-connect term. (short case)  
AV191003•240•

### Flush model - AV9D

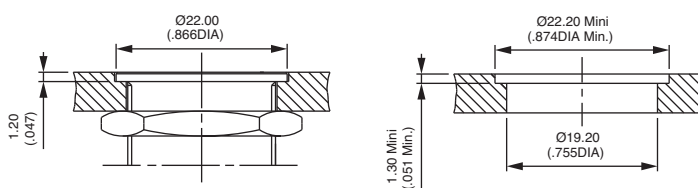

Screw terminals  
AV9D•003•940•  
Solder lug / quick-connect terminals (short case only)  
AV9D1003•240•

Panel cut-out

# AV series

## Anti-vandal pushbutton switches Ø 22 mm (.866)

Momentary (NO)

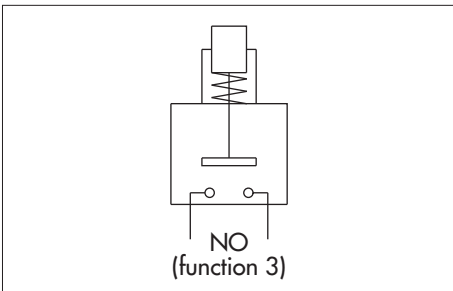

### ORDER FORMAT

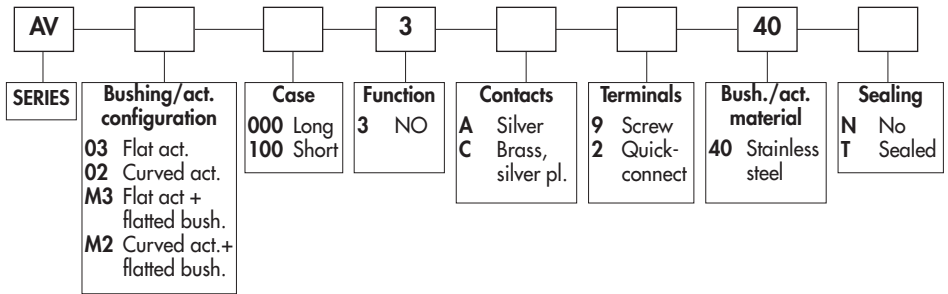

In the following model numbers, replace • with elements selected in the above order format.

B2

### Flat actuator - short case - 48VDC - AV03100

Hex nut 25 (.984) across flats



Screw terminals  
AV031003•940•



Solder lug / quick-connect term.  
AV031003•240•



Screw terminals for wires 1,5 mm<sup>2</sup> max.

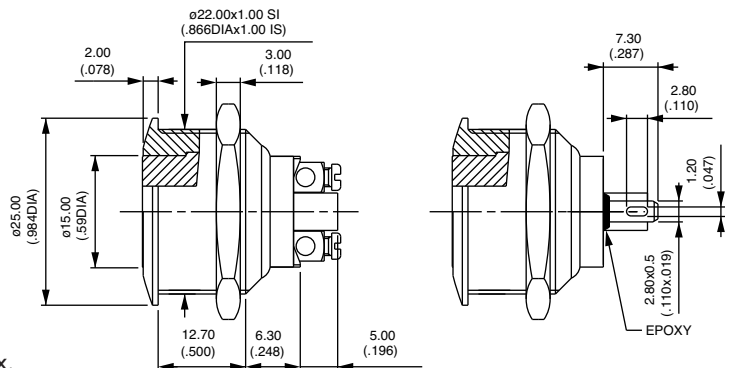

### Flat actuator - long case - 4A 250VAC/8A125VAC - UL/CSA - AV03000

Hex nut 25 (.984) across flats



Screw terminals  
AV030003A940•



To order switches marked **UL-CSA**, add "UU" at the end of model number.

Screw terminals for wires 1,5 mm<sup>2</sup> max.

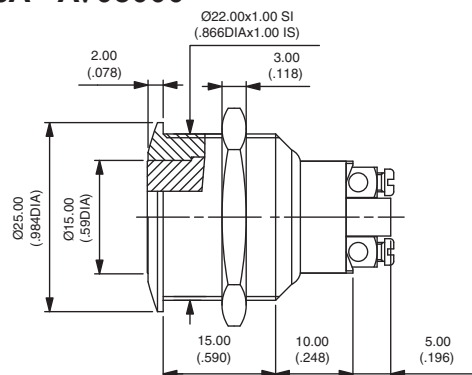

### Curved actuator - AV02

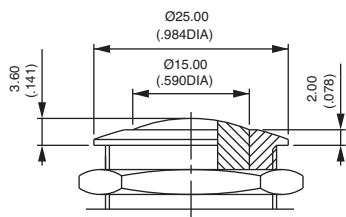

Screw terminals  
AV02•003•940•  
Solder lug / quick-connect (short case)  
AV021003•240•

### Flatted bushing - AVM3 and AVM2

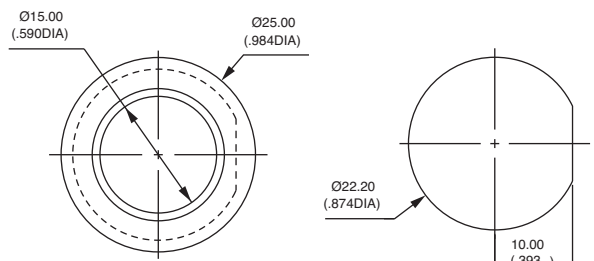

Flat actuator, screw terminals  
AVM3•003•940•

Curved actuator, screw terminals  
AVM2•003•940•

Panel cut-out

# AV series

Snap action security pushbutton switches Ø 16 mm (.629)

Momentary (NO)

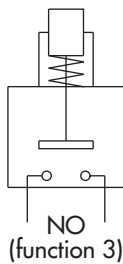
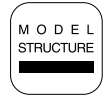

### ORDER FORMAT

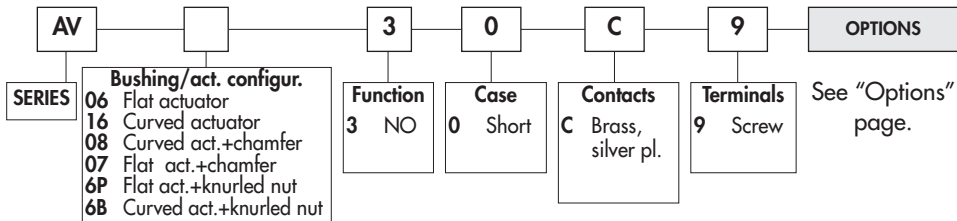

### SPECIFICATIONS

- Travel : 1,60 mm (.063) ± 0,3 mm (.011)
- Max. current/voltage rating with resistive load : 200mA 48 VDC - 100mA 48VDC
- Initial contact resistance : 50 mΩ max.
- Insulation resistance : 1.000 MΩ min. at 500VDC
- Dielectric strength : 2.000 Vrms 50 Hz min. between terminals and frame
- Electrical life : 50.000 cycles at 200mA 48VDC  
100.000 cycles at 100mA 48VDC
- Torque : 5 Nm min.- 14 Nm max. applied to nut
- Panel thickness : 1 (.039) to 6 mm (.236) max.
- Operating temperature : -30°C to +70°C
- Low level or mechanical life : 1.000.000 cycles
- Packaging unit : 60 pieces

### MATERIALS

- Case : PBT
- Contacts : brass, silver plated (C)
- Bushing and actuator : see "Options" page

### CUT-OUT

- Panel cut-out : Ø 16,2 mm (.637)
- Min. pitch for matrix mounting : 24 mm x 24 mm (.944 x .944)  
(AV6P & AV6B : 20 mm x 20 mm)

To order a product, select a basic model below and add the desired options.

### BASIC MODEL

#### Flat or curved actuator - screw terminals

Hex nut 19 (.748) across flats



Flat actuator  
AV0630C9



Curved actuator  
AV1630C9

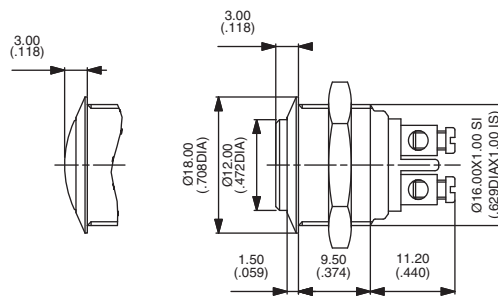

Screw terminals for wires 1,5 mm<sup>2</sup> max.

#### With chamfer

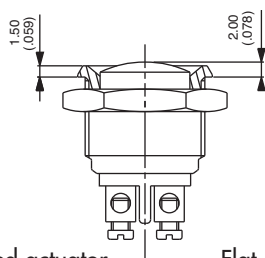

Curved actuator  
AV0830C9

Flat actuator  
AV0730C9

#### With knurled nut for matrix mounting 20 x 20 - AV6P and AV6B

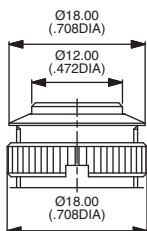

Flat actuator  
AV6P30C9

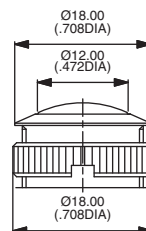

Curved actuator  
AV6B30C9

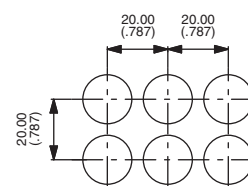

Wrench available under P/N U1990.

MODEL  
STRUCTURE

# AV series

## Security pushbutton switches Ø 16 mm (.629)

Latching action

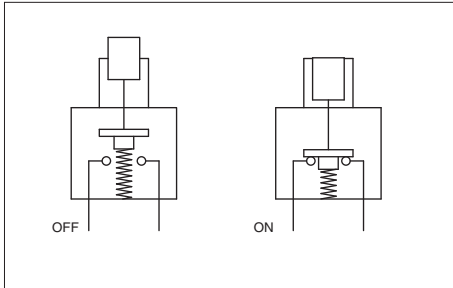

### ORDER FORMAT

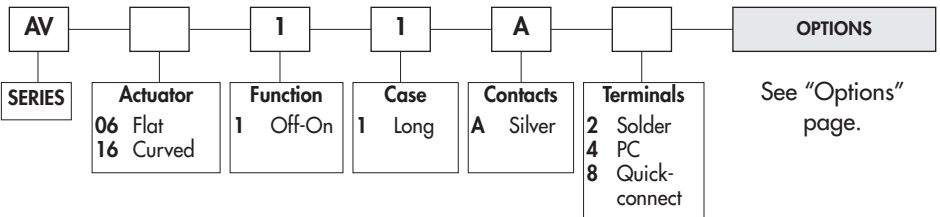

### SPECIFICATIONS

- Max. current/voltage rating with resistive load : 1A 24VDC
- Initial contact resistance : 50mΩ max.
- Insulation resistance : 1 GΩ min. at 500VDC
- Dielectric strength : 1.500 Vrms 50 Hz min. between terminals  
1.000 Vrms 50 Hz between terminals and frame
- Electrical life : 100.000 cycles at 1,5A 250VAC  
40.000 cycles at 1A 24VDC
- Torque : 5 Nm min. - 14 Nm max. applied to nut
- Panel thickness : 1 (.039) to 6 mm (.236) max.
- Operating temperature : -30°C to +70°C
- Low level or mechanical life : 200.000 cycles
- Hand soldering : 300°C, 5 sec. max.
- Packaging unit : 25 pieces

### MATERIALS

- Case : PA-6T, UL94-V0
- Contacts : silver (A)  
*Gold plated silver (AD) on request*
- Bushing and actuator : see "Options" page

### CUT-OUT

- Panel cut-out : Ø 16,2 mm (.637)
- Min. pitch for matrix mounting : 24 mm x 24 mm (.944 x .944)

B2

To order a product, select a basic model below and add the desired options.

### BASIC MODEL

#### Flat or curved actuator - solder lug terminals



Flat actuator  
**AV0611A2**      OFF - ON

Curved actuator  
**AV1611A2**      OFF - ON

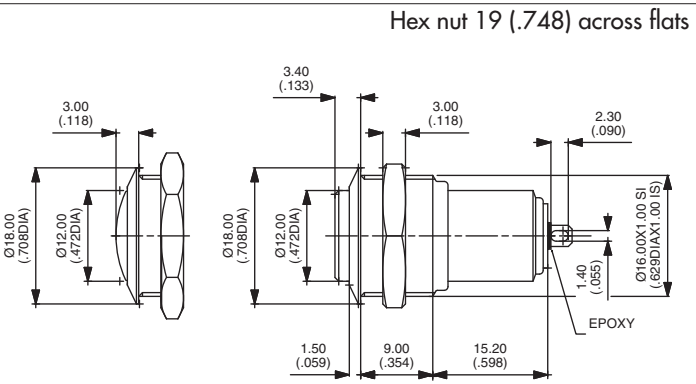

#### Straight PC terminals

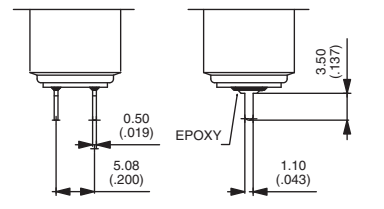

Flat actuator  
**AV0611A4**      Curved actuator  
**AV1611A4**

#### Quick-connect terminals

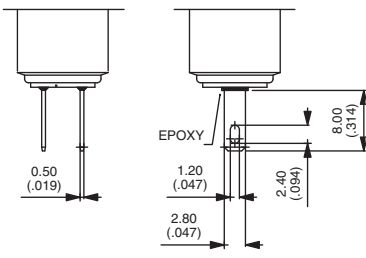

Flat actuator  
**AV0611A8**      Curved actuator  
**AV1611A8**

# AV series

Security pushbutton switches Ø 16 mm (.629)



## Options

After selecting basic model number, fill in last 2 boxes with desired options.

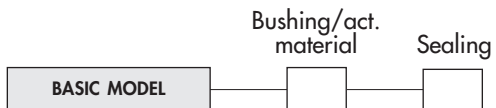

### BUSHING/ACTUATOR MATERIALS

#### Flat or curved metal actuator

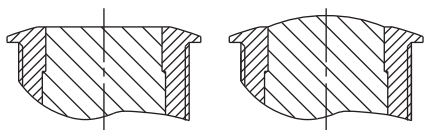

CODE	BUSHING	ACTUATOR
00 (standard)	Nickel plated brass	Nickel plated brass
10	Nickel plated brass	Stainless steel
40	Stainless steel	Stainless steel

B2

### SEALING

- Blank** No sealing
- K** Front panel sealing (IP65)



# AV series

## Security pushbutton switches Ø 19 mm (.748)

Momentary (NO)

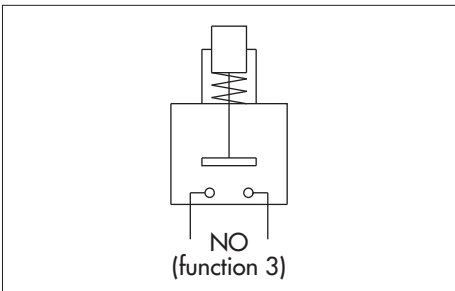

### ORDER FORMAT

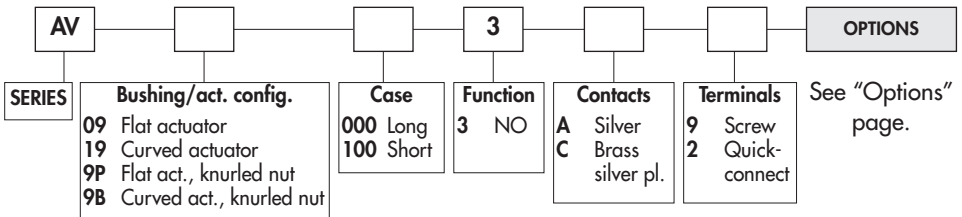

### SPECIFICATIONS

- Max. current/voltage rating with resistive load :
  - A contacts : 4A 12VDC, 500.000 cycles
  - C contacts : 2A 48 VDC, 10.000 cycles
- Approved ratings of models with long case and A contacts (AV.000) :  
UL-CSA : 4A 250VAC - 8A 125VAC - 6.000 cycles
- Initial contact resistance : 10 mΩ max.
- Insulation resistance : 1.000 MΩ min. at 500VDC
- Dielectric strength : 2.000 Vrms 50 Hz min. between terminals and frame  
2.000 Vrms 50 Hz min. between terminals
- Torque : 5 Nm min.- 14 Nm max. applied to nut
- Panel thickness : 1 (.039) to 11 mm (.433) max.
- Operating temperature : -30°C to +70°C
- Low level or mechanical life : 1.000.000 cycles
- Hand soldering : 300°C, 3 sec. max.
- Packaging unit : 40 pieces

### MATERIALS

- Case : PBT
- Contacts : silver (A) or brass, silver plated (C)
- Bushing and actuator : see "Options" page

### CUT-OUT

- Panel cut-out : Ø 19,2 mm (.755)
- Min. pitch for matrix mounting : 30 mm x 30 mm (1.181x1.181) (AV9P & AV9B : 25 mm x 25 mm)

B2

To order a product, select a basic model below and add the desired options.

### BASIC MODEL

#### Flat actuator - short case - 48VDC - AV09100

Hex nut 22 (.866) across flats



Screw terminals  
AV091003•9

Solder lug / quick-connect term.  
AV091003•2



Screw terminals for wires 1,5 mm<sup>2</sup> max.

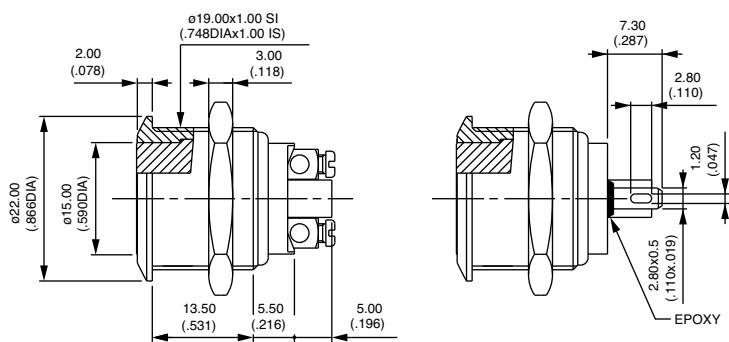

Contacts : replace • with A (silver) or C (silver plated brass).

#### Curved actuator - short case

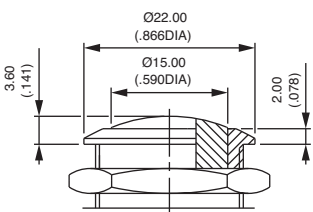

Screw terminals  
AV191003•9  
Solder lug / quick-connect terminals  
AV191003•2

#### With knurled nut for matrix mounting 25 x 25 - AV9P and AV9B

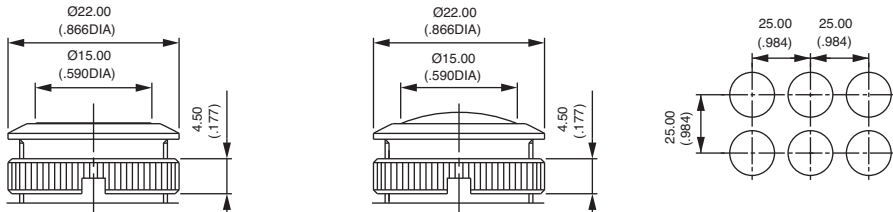

Flat actuator, screw terminals  
AV9P1003•9  
Flat actuator, solder lug term.  
AV9P1003•2

Curved actuator, screw terminals  
AV9B1003•9  
Curved actuator, solder lug term.  
AV9B1003•2

Wrench available under P/N U1929



# AV series

Security pushbutton switches Ø 19 mm (.748)

Momentary (NO)

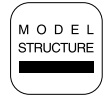

## Flat actuator - long case - 4A 250VAC/8A 125VAC - UL/CSA - AV09000

Hex nut 22 (.866) across flats



Screw terminals  
AV090003A9



To order switches marked **UL-CSA**, add "UU" at the end of model number.

Screw terminals for wires 1,5 mm<sup>2</sup> max.

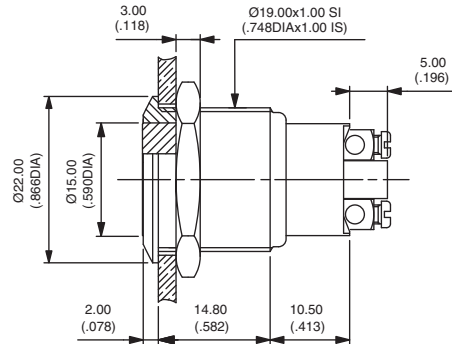

B2

## Curved actuator - long case

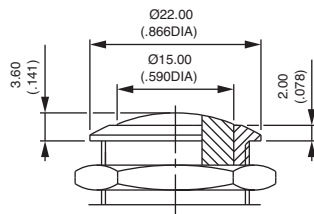

Screw terminals  
AV190003A9

## With knurled nut for matrix mounting 25 x 25 - AV9P and AV9B

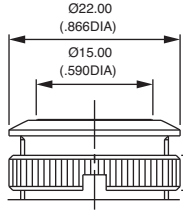

Flat actuator, screw terminals  
AV9P0003A9

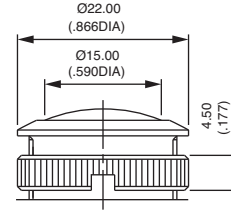

Curved actuator, screw terminals  
AV9B0003A9

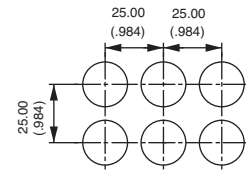

Wrench available under P/N U1929.



# AV series

## Security pushbutton switches Ø 19 mm (.748)

Options

After selecting basic model number, fill in last 3 boxes with desired options.

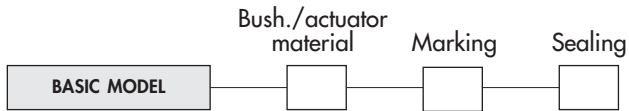

### BUSHING/ACTUATOR MATERIALS

#### Flat or curved metal actuator

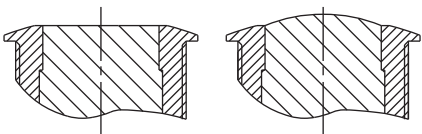

CODE	BUSHING	ACTUATOR
00 (standard)	Nickel plated brass	Nickel plated brass
10	Nickel plated brass	Stainless steel
12	Nickel plated brass	Chrome plated brass
20	Chrome plated brass	Chrome plated brass
30	Chrome plated brass	Stainless steel
40	Stainless steel	Stainless steel
80	Varnished polished brass	Varnished polished brass

#### Flat thermoplastic actuator

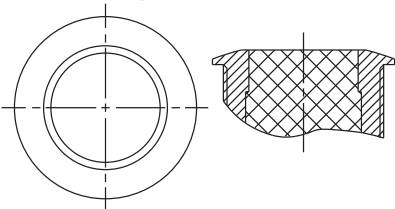

CODE	BUSHING	ACTUATOR COLOUR
0• (standard)	Nickel plated brass	Replace • with one of the following codes.
2•	Chrome plated brass	1 : blue - 1/4 : dark blue - 2 : black - 3 : green
8•	Varnished polished brass	4 : grey - 5 : yellow - 6 : red - 7/1 : white
		9 : orange

### MARKING

Select an option from each of the two tables below.

- By engraving on flat or curved brass actuator (stainless steel on request)
- by hot stamping on flat thermoplastic actuator

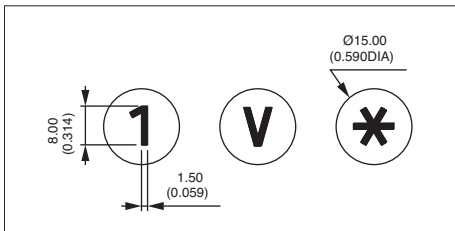

TYPE OF MARKING	
CODE	TYPE
0 to 9	Numbers 0 to 9
X	Symbol *
Y	Symbol #
A to N	Letters A to N
P to W	Letters P to W
0	Letter O

Letter O : same code and same design as number 0.  
For special symbols, consult factory.  
Minimum order : 500 pieces

COLOUR OF MARKING	
CODE	COLOUR
<b>Brass actuator</b>	
0 (standard)	Same as finish
2	Black
Note : a finished product supplied in version "0" cannot be modified to version "2".	
<b>Thermoplastic actuator</b>	
2	Black
7	White

### SEALING

Blank No sealing

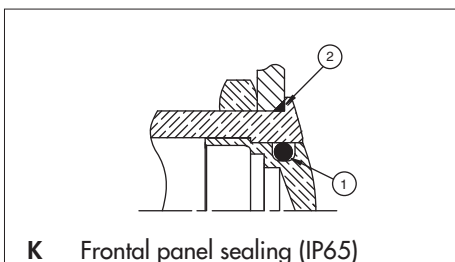

**K** Frontal panel sealing (IP65)

- ① internal gasket
- ② external gasket

B2

# AV series

Security pushbutton switches Ø 19 mm (.748)

Momentary (NC/NO)

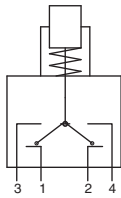

Combined NC/NO

### ORDER FORMAT

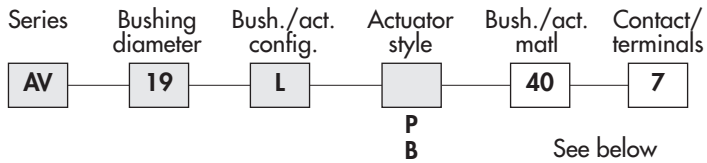

See below

### SPECIFICATIONS

- Max. current/voltage rating with resistive load :  
5A 250VAC - 5A 125VAC - 6.000 cycles  
5A 15VDC - 3A 30VDC - 50.000 cycles
- Initial contact resistance : 100 mΩ max.
- Insulation resistance : 1.000 MΩ min. at 500VDC
- Dielectric strength : 2.000 Vrms 50 Hz min. between term. and frame
- Torque : 5 Nm min.- 14 Nm max. applied to nut
- Panel thickness : 1 (.039) to 9 mm (.354) max.
- Operating temperature : -20°C to +85°C
- Low level or mechanical life : 1.000.000 cycles
- Front panel sealing : IP65 and IP69K
- Packaging unit : 20 pieces

### MATERIALS

- Case : PA 6/6
- Contacts : silver
- Bushing : stainless steel (std)
- Actuator : stainless steel (std)

### CUT-OUT

- Panel cut-out : Ø 19,2 mm (.755)
- Min. pitch for matrix mounting :  
30 mm x 30 mm (1.181x1.181)

All model numbers below are for switches with standard bushing/actuator material.

### BASIC MODEL

#### Solder lug terminals - AV19..407



Flat actuator  
AV19LP407

Curved actuator  
AV19LB407

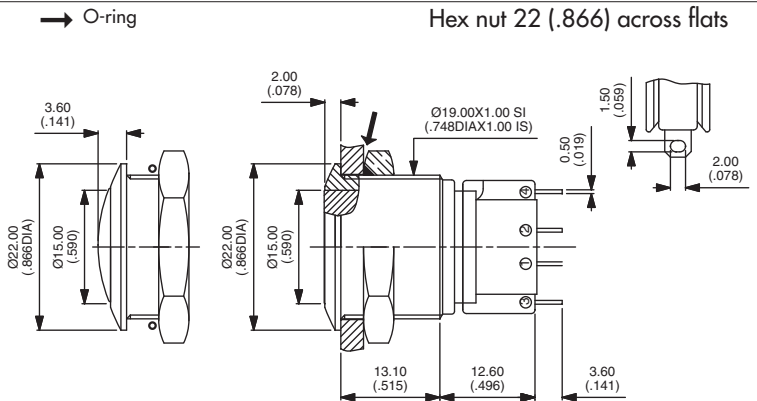
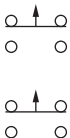

### BUSHING/ACTUATOR MATERIALS

For non-standard material, replace **40** with one of the following codes.

CODE	BUSHING	ACTUATOR
00	Nickel plated brass	Nickel plated brass
20	Chrome plated brass	Chrome plated brass



# AV series

## Security pushbutton switches Ø 19 mm (.748)

With illuminated ring - momentary (NC/NO)

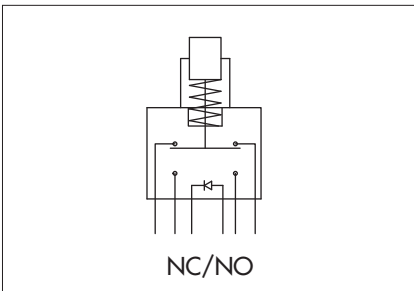

### ORDER FORMAT

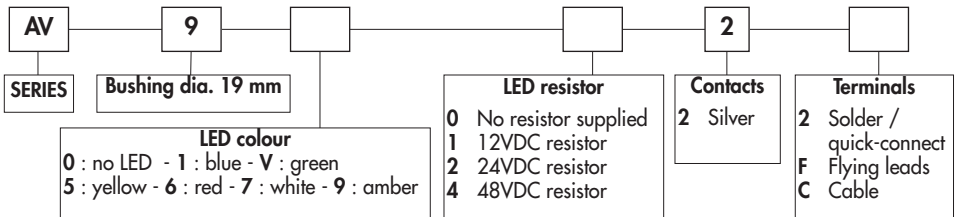

### SPECIFICATIONS

- Travel : 2 mm ± 0,3 mm (.003)
  - Max. current/voltage rating with resistive load : 1 A 30VDC
  - LED voltage : 12VDC, 24VDC or 48VDC (If not supplied by APEM, a resistor must be series-connected by the user)\*\*
  - Initial contact resistance : 100 mΩ max.
  - Insulation resistance : 10 MΩ min. at 500VDC
  - Dielectric strength : 500 Vrms 50 Hz min. between terminals 1.000 Vrms 50 Hz min. between terminals and frame
  - Electrical life : 250.000 cycles at full load
  - Operating force : 5N ± 2N
  - Torque : 5 Nm min.- 14 Nm max. applied to nut
  - Panel thickness : 1 (.039) to 6 mm (.236) max.
  - Low level or mechanical life : 1.000.000 cycles
  - Operating temperature : -20°C to +55°C
  - Hand soldering : 350°C, 5 seconds max.
  - Packaging unit : flying lead/cable models : 1 piece - other models : 40 pieces
- \*\* Resistor value =  $\frac{\text{supply voltage} - \text{LED forward voltage}}{\text{LED forward current}}$

### MATERIALS

- Case : polyamide, glass filled
- Contacts : silver
- Bushing : see next page
- Actuator : see next page
- Elastomeric membrane : silicone
- LED

### CUT-OUT

- Panel cut-out : Ø 19,2 mm (.755)
- Min. pitch for matrix mounting : 30 mm x 30 mm (1.181x1.181)

To order a product, select a basic model below and add the desired LED colour and voltage. Then select the desired options on next page.

### Flat actuator - solder lug terminals



Illuminated (select LED colour) \*  
**AV9•022**

Non-illuminated  
**AV90022**

\* No LED resistor supplied on this model.

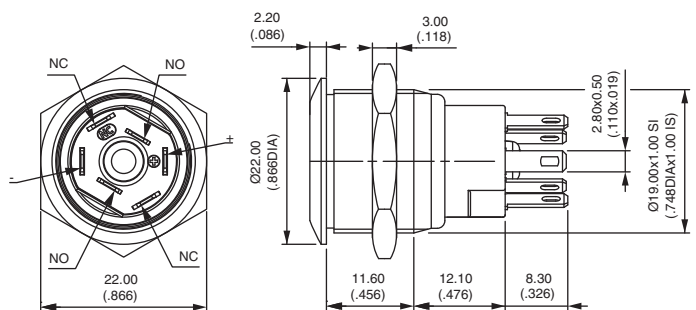

### Flat actuator - flying lead terminals



Illuminated (select LED colour & resistor above)  
**AV9••2F**

Non-illuminated  
**AV9002F**

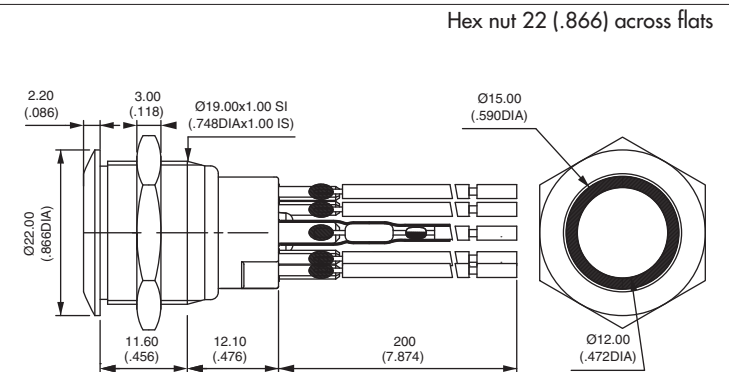

Wire colours : black: NC, orange: NO, red: LED anode (+), blue : LED cathode (-)

# AV series

Security pushbutton switches Ø 19 mm (.748)

With illuminated ring - momentary (NC/NO)



## Flat actuator - cable terminals

Hex nut 22 (.866) across flats



Illuminated (select colour & resistor)  
**AV9••2C**

Non-illuminated  
**AV9002C**

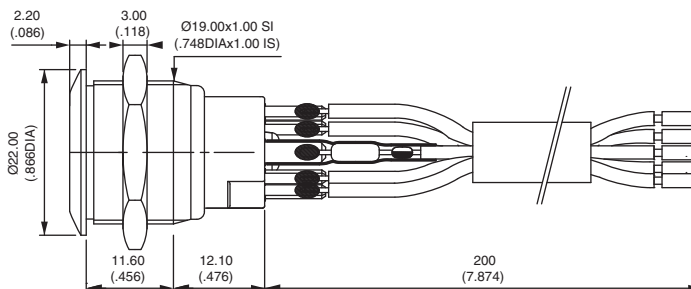

B2

After selecting basic model No., fill in last 5 boxes with desired options.

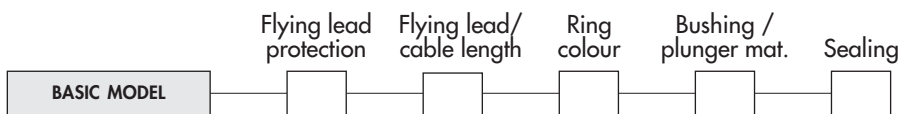

### FLYING LEAD PROTECTION

- 0 No protection and/or no flying leads
- 1 Heat-shrink sleeves
- 2 Tube + epoxy

### FLYING LEAD/CABLE LENGTH

- 000 No flying leads / no cable
- 020 Length 20 cm (standard)
- XXX Length in centimeters

### RING COLOURS

CODE	COLOUR	CODE	COLOUR
1	Blue	6	Red
2	Black *	7	Opal white (std)
3	Green	8	Translucent
4	Grey *	9	Orange
5	Yellow		

\* non-illuminated only

### BUSHING/PLUNGER MATERIALS

CODE	BUSHING	ACTUATOR
00	Brass, nickel plated	Brass, nickel plated
40	Stainless steel 303	Stainless steel 303
4A	Stainless steel 304	Stainless steel 304
4B	Stainless steel 316	Stainless steel 316

Other : on request.

### SEALING

Blank No sealing



**K** Front panel sealing (IP67)

- ① internal membrane
- ② external gasket



# AV series

## Security pushbutton switches Ø 19 mm (.748)

*Illuminated and non-illuminated - latching*

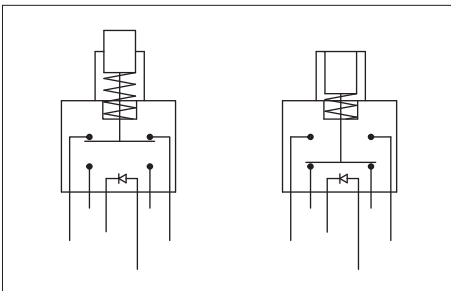

### ORDER FORMAT

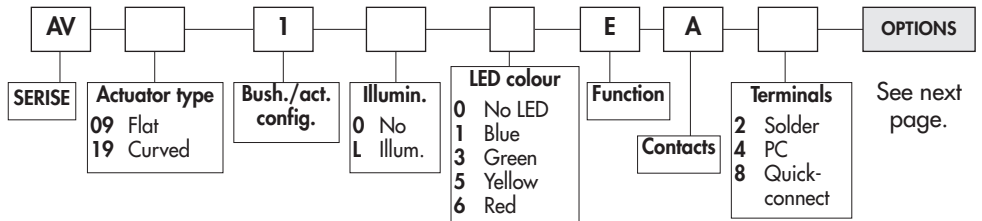

### SPECIFICATIONS

- Max. current/voltage rating with resistive load : 2A 48 VDC
  - LED voltage and consumption : blue 3,5V 10mA, green : 2V 10mA, yellow & red : 2V 20mA (a resistor must be series-connected by the user)\*\*
  - Initial contact resistance : 50 mΩ max.
  - Insulation resistance : 1.000 MΩ min. at 500VDC
  - Dielectric strength : 1 000 Vrms 50 Hz min. between terminals, 500 Vrms 50 Hz min. between terminals and frame
  - Electrical life : 500.000 cycles at 2A 48VDC
  - Torque : 5 Nm min.- 14 Nm max. applied to nut
  - Panel thickness : 1 (.039) to 9 mm (.354) max.
  - Operating temperature : -30°C to +70°C
  - Low level or mechanical life : 1.000.000 cycles
  - Hand soldering : 300°C, 4 seconds max.
  - Packaging unit : 20 pieces
- \*\* Resistor value =  $\frac{\text{supply voltage} - \text{LED forward voltage}}{\text{LED forward current}}$

### MATERIALS

- Case : PA6T UL94-V0
- Contacts : silver
- Bushing and actuator : see next page
- LED

### CUT-OUT

- Panel cut-out : Ø 19,2 mm (.755)
- Min. pitch for matrix mounting : 30 mm x 30 mm (1.181 x 1.181)

To order a product, select a basic model below and add the desired options selected on next page.

**B2**

Standard actuator position : the actuator is flush in the non-latched position and recessed in the latched position.

### Non-illuminated - solder lug terminals



Flat actuator \*  
**AV09100EA2** ON - ON

Curved actuator  
**AV19100EA2** ON - ON

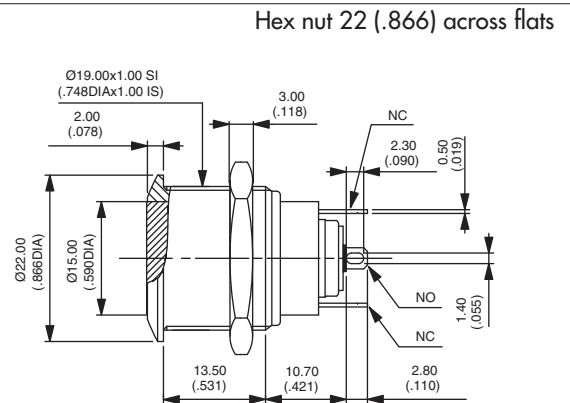
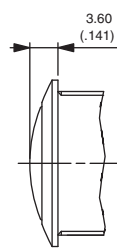

\* Also available with prominent actuator in the non-latched position

### Illuminated - solder lug terminals



Flat actuator  
**AV091L•EA2** ON - ON

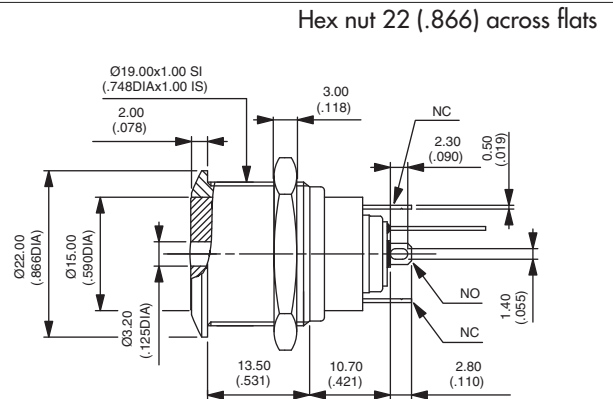

Replace • with desired LED colour.



# AV series

## Security pushbutton switches Ø 19 mm (.748)

### Latching - Options

#### Straight PC terminals

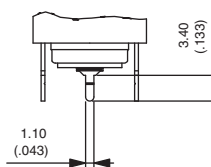

Replace 2 with 4 at the end of the model numbers shown on previous page.

#### Quick-connect terminals

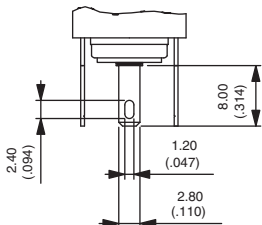

Replace 2 with 8 at the end of the model numbers shown on previous page.

B2

After selecting basic model number, fill in last 2 boxes with desired options.



#### BUSHING/ACTUATOR MATERIALS

CODE	BUSHING	ACTUATOR
00 (std)	Nickel plated brass	Nickel plated brass
10	Nickel plated brass	Stainless steel
40	Stainless steel	Stainless steel
50	Stainless steel	Nickel plated brass

#### SEALING

Blank No sealing

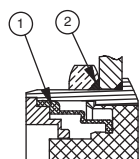

**K** Frontal panel sealing (IP65)

- ① elastomeric membrane
- ② external gasket



# AV series

## Snap-action security pushbutton switches Ø 19 mm (.748)

*Illuminated and non-illuminated - momentary (NO)*

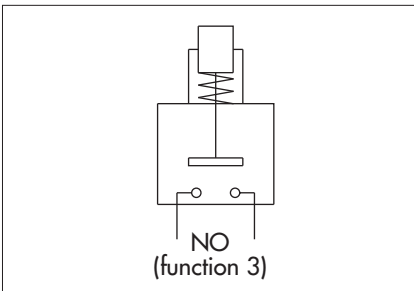

### ORDER FORMAT

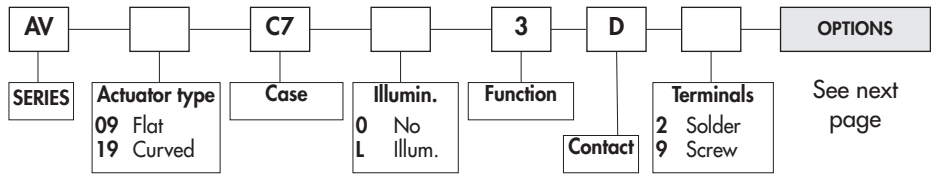

### SPECIFICATIONS

- **Travel : 0,7 mm (.027) ±0,1 mm (.003)**
- Max. current/voltage rating with resistive load : 50mA 24VDC
- LED voltage and consumption : 2-colour LED : 2V (3V max.) 20mA  
Other colours : 2V (3V max.) 10mA  
A resistor must be series-connected by the user \*\*
- Initial contact resistance : 100 mΩ max.
- Insulation resistance : 1.000 MΩ min. at 500VDC
- Dielectric strength : 500 Vrms 50 Hz min. between terminals  
2.000 Vrms 50 Hz min. between terminals and frame
- Electrical life : 1.000.000 cycles at full load
- Operating force : 7 N ±2N
- Torque : 5 Nm min.- 14 Nm max. applied to nut
- Panel thickness : 1 (.039) to 6 mm (.236) max.
- Operating temperature : -30°C to +70°C
- Hand soldering : 270°C, 3 seconds max.
- Packaging unit : 40 pieces

\*\* Resistor value =  $\frac{\text{supply voltage} - \text{LED forward voltage}}{\text{LED forward current}}$

### MATERIALS

- Case : PBT UL94-V0
- Terminals : brass, gold plated
- Contacts : gold plated dome
- Bushing and actuator : see next page
- LED

### CUT-OUT

- Panel cut-out : Ø 19,2 mm (.755)
- Min. pitch for matrix mounting : 30 mm x 30 mm (1.181x1.181)

To order a product, select a basic model below and add the desired options selected on next page.

### Flat actuator - non-illuminated



Solder lug terminals  
**AV09C703D2**

Screw terminals  
**AV09C703D9**

Also available with curved actuator :  
**AV19C703D2** or **AV19C703D9**

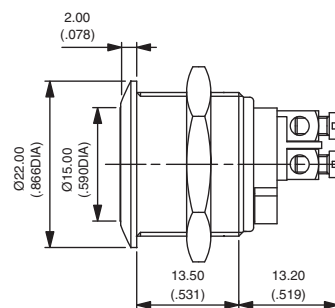

Hex nut 22 (.866) across flats

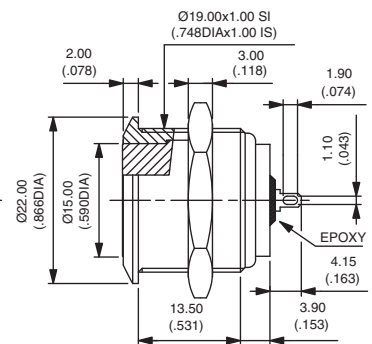

### Flat actuator - illuminated



Solder lug terminals  
**AV09C7L3D2**

Screw terminals  
**AV09C7L3D9**

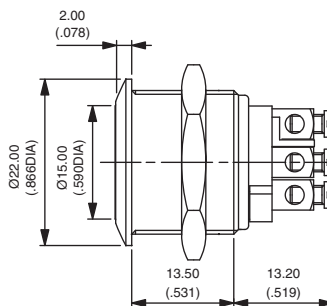

Hex nut 22 (.866) across flats

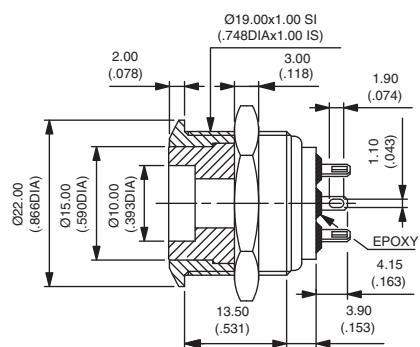



# AV series

## Snap-action security pushbutton switches Ø 19 mm (.748)



### Options

After selecting basic model no., fill in last 4 boxes with desired options.

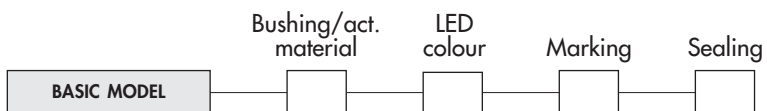

### BUSHING/ACTUATOR MATERIALS

Non-illuminated models		
CODE	BUSHING	ACTUATOR
00 (std)	Nickel plated brass	Nickel plated brass
10	Nickel plated brass	Stainless steel
30	Chrome plated brass	Stainless steel
40	Stainless steel	Stainless steel
80	Varnished polished brass	Varnished polished brass

Illuminated models		
CODE	BUSHING	ACTUATOR
00 (std)	Nickel plated brass	Nickel plated brass
20	Chrome plated brass	Chrome plated brass
40	Stainless steel	Stainless steel
50	Stainless steel	Nickel plated brass
80	Varnished polished brass	Varnished polished brass

### LED COLOURS

Blank No LED

1 : Blue - 3 : Green - 5 : Yellow - 6 : Red - 7 : White - 9 : Amber - 2 : Red/green

### MARKING

For flat or curved actuator.

- by engraving on non-illuminated brass actuator (stainless steel on request).
- by hot stamping on thermoplastic insert (illuminated actuators)

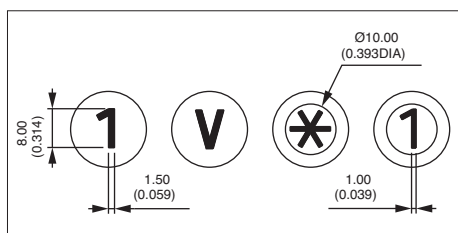

Select an option from each of the two tables below.

TYPE OF MARKING	
CODE	TYPE
0 to 9	Numbers 0 to 9
X	Symbol *
Y	Symbol #
A to N	Letters A to N
P to W	Letters P to W
0	Letter O

Letter O : same code and same design as number 0.  
For special symbols, consult factory.  
Minimum order : 500 pieces

COLOUR OF MARKING	
CODE	COLOUR
<b>Non-illuminated actuators</b>	
0 (standard)	Same as finish
2	Black
Note : a finished product supplied in version "0" cannot be modified to version "2".	
<b>Illuminated actuators</b>	
2	Black (on white)

### SEALING

Blank No sealing

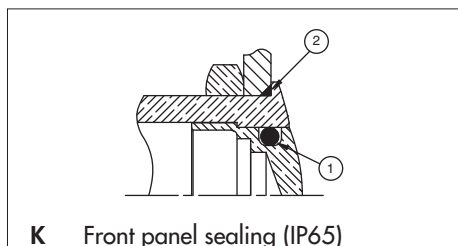

**K** Front panel sealing (IP65)

- ① internal gasket
- ② external gasket



# AV series

## Snap-action security pushbuttons Ø 19 mm (.748) with overmolded actuator

Illuminated and non-illuminated - momentary (NO)

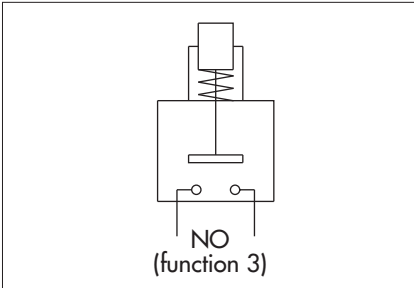

### ORDER FORMAT

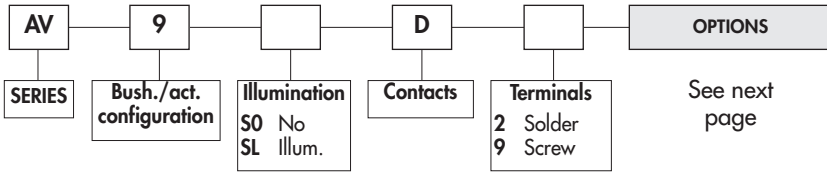

### SPECIFICATIONS

- **Travel : 0,7 mm (.027) ± 0,1 mm (.003)**
- **Max. current/voltage rating with resistive load : 50mA 24VDC**
- **LED voltage and consumption : 2-colour LED : 2V (3V max.) 20mA**  
Other colours : 2V (3V max.) 10mA  
(a resistor must be series-connected by the user)\*\*
- **Initial contact resistance : 100 mΩ max.**
- **Insulation resistance : 1.000 MΩ min. at 500VDC**
- **Dielectric strength : 500 Vrms 50 Hz min. between terminals**  
2.000 Vrms 50 Hz min. between terminals and frame
- **Electrical life : 1.000.000 cycles at full load**
- **Operating force : 7 N ±2N**
- **Torque : 5 Nm min.- 14 Nm max. applied to nut**
- **Panel thickness : 1 (.039) to 6 mm (.236) max.**
- **Operating temperature : -30°C to +70°C**
- **Hand soldering : 270°C, 3 sec. max.**
- **Packaging unit : 16 pieces**

\*\* Resistor value =  $\frac{\text{supply voltage} - \text{LED forward voltage}}{\text{LED forward current}}$

### MATERIALS

- **Case : PBT UL94-V0**
- **Terminals : brass, gold plated**
- **Contacts : gold plated dome**
- **Bushing : see next page**
- **Actuator : stainless steel, with thermoplastic overmolding**
- **LED**

### CUT-OUT

- **Panel cut-out : Ø 19,2 mm (.755)**
- **Min. pitch for matrix mounting : 30 mm x 30 mm (1.181x1.181)**

To order a product, select a basic model below and add the desired options selected on next page.

### Flat actuator - solder lug terminals



Illuminated  
**AV9SLD2**



Non-illuminated  
**AV9SOD2**



Also available with bushing Ø 22 (.866) : on request.

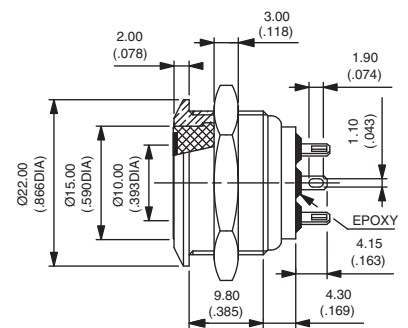
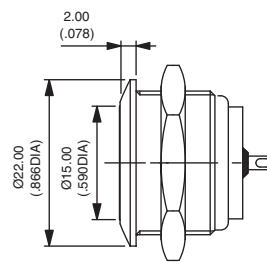

Hex nut 22 (.866) across flats

### Flat actuator - screw terminals



Illuminated  
**AV9SLD9**



Non-illuminated  
**AV9SOD9**



Also available with bushing Ø 22 (.866) : on request.

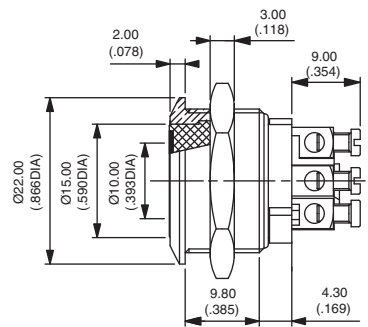
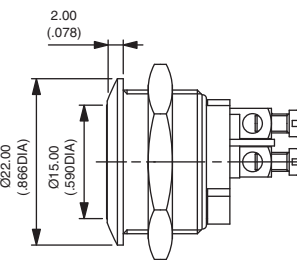

Hex nut 22 (.866) across flats

# AV series

## Snap-action security pushbuttons Ø 19 mm (.748) with overmolded actuator

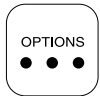

### Options

After selecting basic model no., fill in last 5 boxes with desired options.

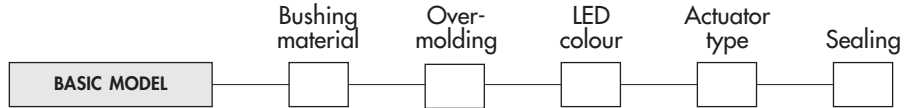

#### BUSHING MATERIALS

CODE	MATERIAL
0 (std)	Nickel plated brass
2	Chrome plated brass
4	Stainless steel
5	Gold plated brass
6	Chrome plated brass, satin
7	Chrome pl. brass, matt black
8	Varnished polished brass
9	Polished brass

#### OVERMOLDING COLOURS

CODE	COLOUR	CODE	COLOUR
1	Blue	6	Red
2	Black *	7	White
3	Green	8	Translucent
4	Grey *	9	Orange
5	Yellow		

\* non-illuminated only

#### LED COLOURS

CODE	COLOUR
Blank	No LED
1	Blue
2	Red/green
3 **	Green
V **	Green, high intensity
5	Yellow
6	Red
7	White
9	Amber

\*\* To order a green LED for actuator style 002, always use code V. Other actuator styles can be ordered with LED code 3 or V.

#### ACTUATOR STYLES

The ring and symbols are obtained by photochemical engraving of a stainless steel insert. The insert is then overmolded in the desired colour.

The following actuator styles are available. For other types, consult factory.

CODE	001	002	003	004	005
DESCRIPTION	Illuminated ring and disc	Illuminated ring	Arrow	Loudspeaker OFF	Opening
RING/SYMBOL					

CODE	006	008	009	010	011
DESCRIPTION	Validation	Closing	Standby	Cancel	Power
SYMBOL					

#### SEALING

**Blank** No sealing

**K** Front panel sealing (IP67)

- ① internal membrane
- ② external gasket

Recommended panel mounting for IP69K

**K** Front panel sealing (IP69K)

# AV series

## Snap-action security pushbuttons Ø 22 mm (.866) with overmolded actuator

*Illuminated and non-illuminated - momentary (NO)*

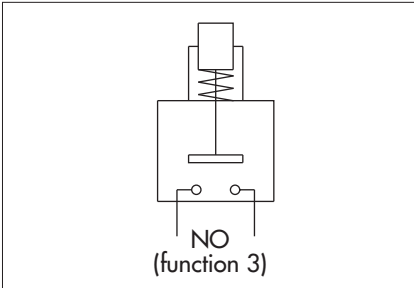

### ORDER FORMAT

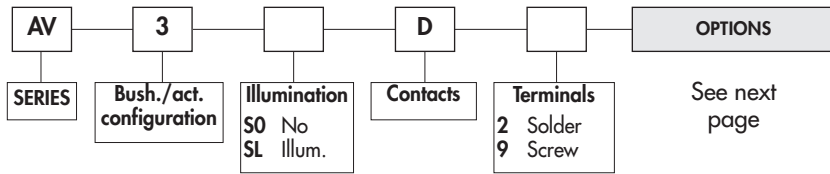

### SPECIFICATIONS

- **Travel : 0,7 mm (.027) ± 0,1 mm (.003)**
- **Max. current/voltage rating with resistive load : 50mA 24VDC**
- **LED voltage and consumption : 2-colour LED : 2V (3V max.) 20mA**  
Other colours : 2V (3V max.) 10mA  
(a resistor must be series-connected by the user)\*\*
- **Initial contact resistance : 100 mΩ max.**
- **Insulation resistance : 1.000 MΩ min. at 500VDC**
- **Dielectric strength : 500 Vrms 50 Hz min. between terminals**  
2.000 Vrms 50 Hz min. between terminals and frame
- **Electrical life : 1.000.000 cycles at full load**
- **Operating force : 7 N ±2N**
- **Torque : 5 Nm min.- 14 Nm max. applied to nut**
- **Panel thickness : 1 (.039) to 6 mm (.236) max.**
- **Operating temperature : -30°C to +70°C**
- **Hand soldering : 270°C, 3 sec. max.**
- **Packaging unit : 16 pieces**

\*\* Resistor value =  $\frac{\text{supply voltage} - \text{LED forward voltage}}{\text{LED forward current}}$

### MATERIALS

- **Case : PBT UL94-V0**
- **Terminals : brass, gold plated**
- **Contacts : gold plated dome**
- **Bushing : see next page**
- **Actuator : stainless steel, with thermoplastic overmolding**
- **LED**

### CUT-OUT

- **Panel cut-out : Ø 22,2 mm (.874)**
- **Min. pitch for matrix mounting : 30 mm x 30 mm (1.181x1.181)**

To order a product, select a basic model below and add the desired options selected on next page.

### Flat actuator - solder lug terminals



Illuminated  
**AV3SLD2**

Non-illuminated  
**AV3SOD2**

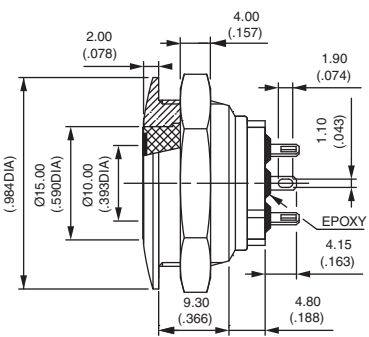
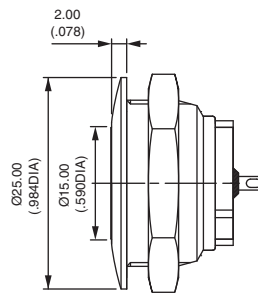
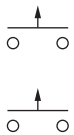

Hex nut 25 (.984) across flats

### Flat actuator - screw terminals



Illuminated  
**AV3SLD9**

Non-illuminated  
**AV3SOD9**

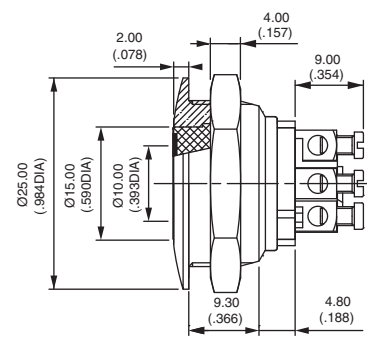
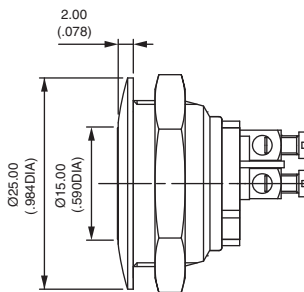

Hex nut 25 (.984) across flats

# AV series

## Snap-action security pushbuttons Ø 22 mm (.866) with overmolded actuator

### Options

After selecting basic model no., fill in last 5 boxes with desired options.

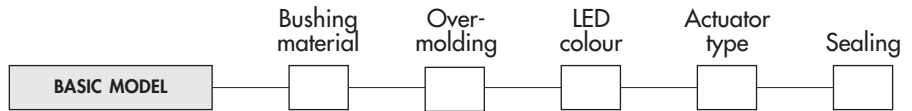

#### BUSHING MATERIALS

CODE	MATERIAL
0 (std)	Nickel plated brass
2	Chrome plated brass
4	Stainless steel
5	Gold plated brass
6	Chrome plated brass, satin
7	Chrome pl. brass, matt black
8	Varnished polished brass
9	Polished brass

#### OVERMOLDING COLOURS

CODE	COLOUR	CODE	COLOUR
1	Blue	6	Red
2	Black *	7	White
3	Green	8	Translucent
4	Grey *	9	Orange
5	Yellow		

\* non-illuminated only

#### LED COLOURS

CODE	COLOUR
Blank	No LED
1	Blue
2	Red/green
3 **	Green
V **	Green, high intensity
5	Yellow
6	Red
7	White
9	Amber

\*\* To order a green LED for actuator style 002, always use code V. Other actuator styles can be ordered with LED code 3 or V.

#### ACTUATOR STYLES

The ring and symbols are obtained by photochemical engraving of a stainless steel insert. The insert is then overmolded in the desired colour.

The following actuator styles are available. For other types, consult factory.

CODE	001	002	003	004	005
DESCRIPTION	Illuminated ring and disc	Illuminated ring	Arrow	Loudspeaker OFF	Opening
RING/SYMBOL					

CODE	006	008	009	010	011
DESCRIPTION	Validation	Closing	Standby	Cancel	Power
SYMBOL					

#### SEALING

Blank No sealing

**K** Front panel sealing (IP67)

- ① internal membrane
- ② external gasket

Recommended panel mounting for IP69K

**K** Front panel sealing (IP69K)



# AV series

## Security pushbutton switches Ø 22 mm (.866)

Momentary (NO)

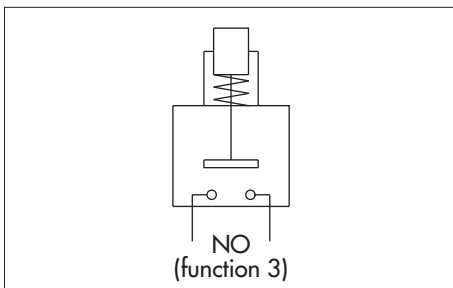

### ORDER FORMAT

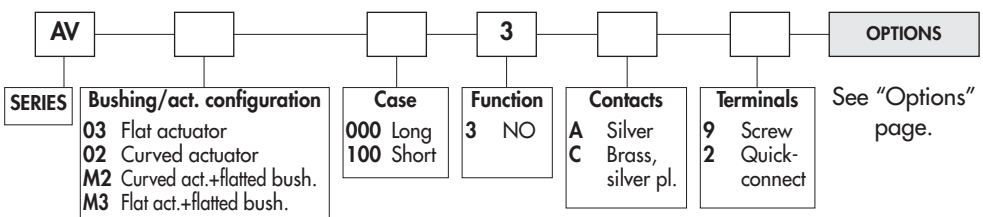

### SPECIFICATIONS

- Max. current/voltage rating with resistive load :
  - A contacts : 4A 12VDC, 500.000 cycles
  - C contacts : 2A 48 VDC, 10.000 cycles
- Approved ratings of models with long case and A contacts (AV..000) :
  - UL-CSA : 4A 250VAC - 8A 125VAC - 6.000 cycles
- Initial contact resistance : 10 mΩ max.
- Insulation resistance : 1.000 MΩ min. at 500VDC
- Dielectric strength : 2.000 Vrms 50 Hz min. between terminals and frame
- Torque : 5 Nm min.- 14 Nm max. applied to nut
- Panel thickness : 1 (.039) to 11 mm (.433) max.
- Operating temperature : -30°C to +70°C
- Low level or mechanical life : 1.000.000 cycles
- Hand soldering : 300°C, 3 sec. max.
- Packaging unit : 20 pieces

### MATERIALS

- Case : PBT
- Contacts : silver (A) or brass, silver plated (C)
- Bushing and actuator : see "Options" page

### CUT-OUTS

- Panel cut-out : Ø 22,2 mm (.874)
- Min. pitch for matrix mounting : 30 mm x 30 mm (1.181x1.181)

B2

To order a product, select a basic model below or on next page and add the desired options.

### BASIC MODEL

#### Flat actuator - short case - 48VDC - AV03100

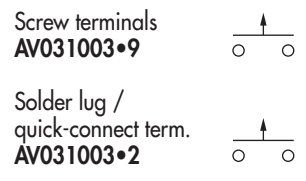

Screw terminals for wires 1,5 mm<sup>2</sup> max.

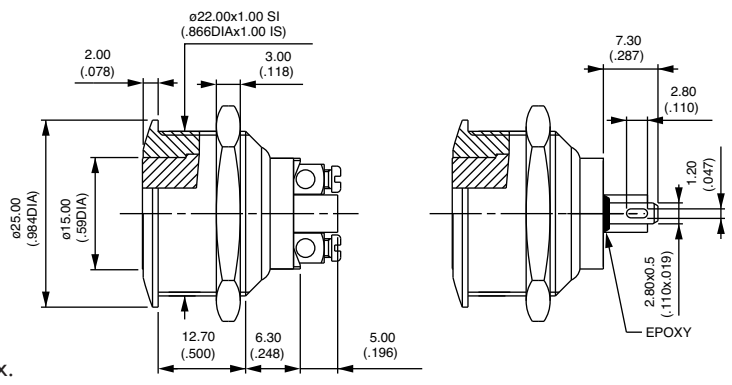

Contacts : replace • with A (silver) or C (silver plated brass).

#### Curved actuator - short case

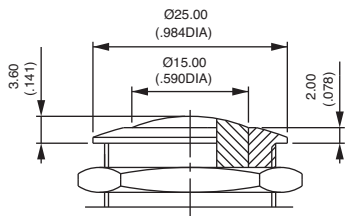

Screw terminals  
**AV021003•9**  
Solder lug / quick-connect terminals  
**AV021003•2**

#### Flatted bushing - short case - AVM3 and AVM2

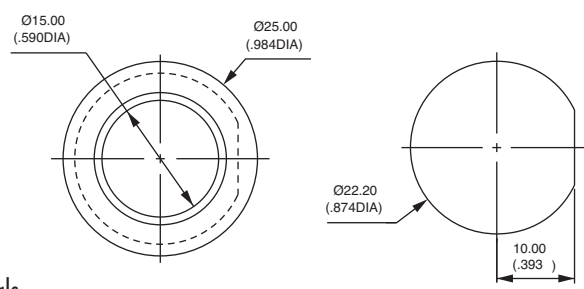

Flat actuator, screw terminals  
**AVM31003•9**  
Curved actuator, screw terminals  
**AVM21003•9**

# AV series

Security pushbutton switches Ø 22 mm (.866)

Momentary (NO) - momentary (NC) - alternate action

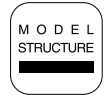

## Flat actuator - long case - 4A 250VAC/8A 125VAC - UL/CSA - AV03000

Hex nut 25 (.984) across flats



Screw terminals  
AV030003A9



To order switches marked **UL-CSA**, add "UU" at the end of model number.

Screw terminals for wires 1,5 mm<sup>2</sup> max.

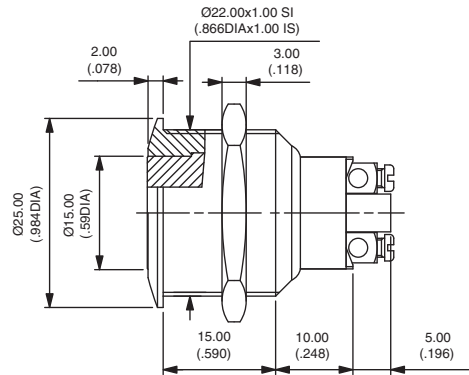

B2

## Curved actuator - long case

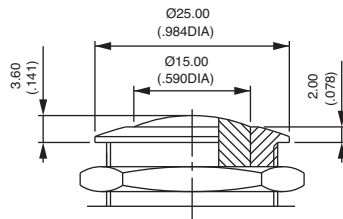

Screw terminals  
AV020003A9

## Flatted bushing - long case - AVM3 and AVM2

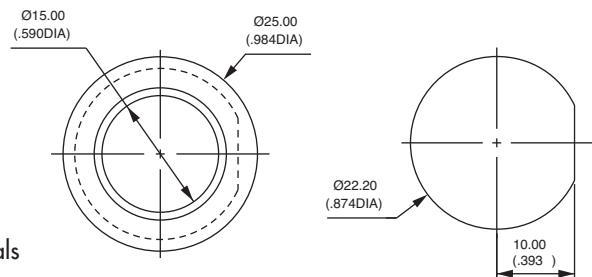

Flat actuator, screw terminals  
AVM30003•9  
Curved actuator, screw terminals  
AVM20003•9

## MOMENTARY NORMALLY CLOSED MODEL (NC)

### Bushing Ø 22 (.866) - AV..1200

Hex nut 25 (.984) across flats

- Single pole, screw terminals, without marking
- Silver plated copper contacts (C)
- Max. current/voltage rating with resistive load : 2A 250VAC - 3A 125VAC - 2,5A 24VDC
- Dielectric strength : 2.000 Vrms 50 Hz min. betw. term. and frame 2.000 Vrms. 50 Hz min. between terminals
- Electrical life : 100.000 cycles at 0,3A 24VAC or DC 10.000 cycles at full load
- Packaging unit : 20 pieces

Flat actuator  
AV031202C900

Curved actuator  
AV021202C900

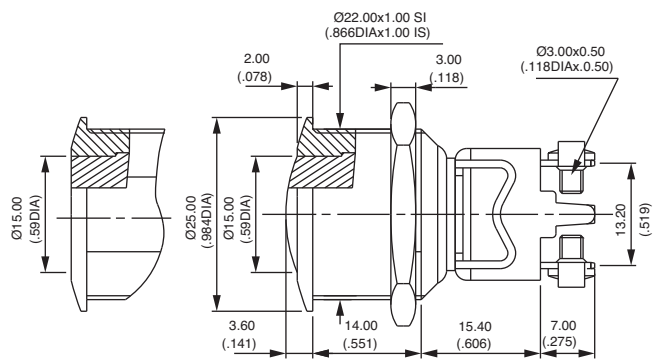

### Bushing Ø 22 (.866) - alternate action - AV..4700

Hex nut 25 (.984) across flats

- Double pole, solder lug/quick-connect term., curved actuator
- Silver contacts
- Max. current/voltage rating with resistive load : 3(1,5)A 250VAC - 6A 125VAC - 3A 24VAC or DC
- Dielectric strength : 3.000 Vrms min. between terminals and frame
- Electrical life : 10.000 cycles at full load 50.000 cycles at 1A 24VAC or DC
- Mechanical life : 100.000 cycles
- Packaging unit : 10 pieces

AV044746A200

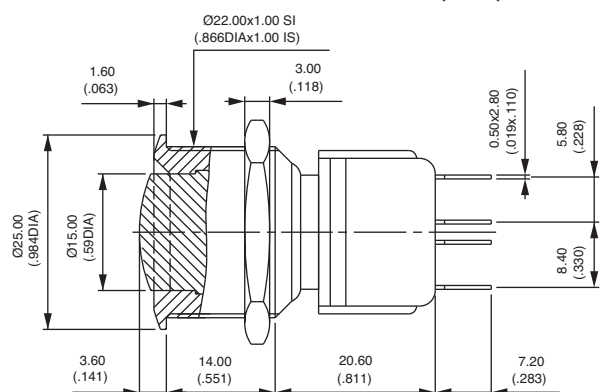

Further specifications : see previous page. Bushing/actuator materials, marking and sealing : see "options" on next page.



# AV series

## Security pushbutton switches Ø 22 mm (.866)

Options

After selecting basic model number, fill in last 3 boxes with desired options.

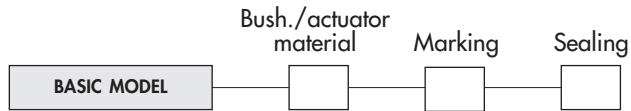

### BUSHING/ACTUATOR MATERIALS

#### Flat or curved metal actuator

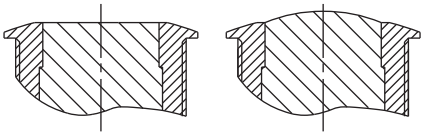

CODE	BUSHING	ACTUATOR
<b>00 (standard)</b>	<b>Nickel plated brass</b>	<b>Nickel plated brass</b>
<b>10</b>	Nickel plated brass	Stainless steel
<b>12</b>	Nickel plated brass	Chrome plated brass
<b>20</b>	Chrome plated brass	Chrome plated brass
<b>30</b>	Chrome plated brass	Stainless steel
<b>40</b>	Stainless steel	Stainless steel
<b>80 **</b>	Varnished polished brass	Varnished polished brass

#### Flat thermoplastic actuator

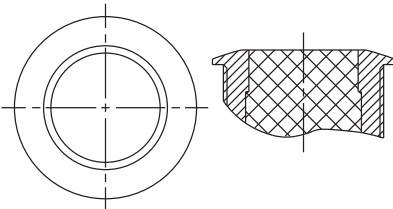

CODE	BUSHING	ACTUATOR COLOUR
<b>0• (standard)</b>	<b>Nickel plated brass</b>	Replace • with one of the following codes.
<b>2•</b>	Chrome plated brass	<b>1</b> : blue - <b>1/4</b> : dark blue - <b>2</b> : black - <b>3</b> : green
<b>8•</b>	Varnished polished brass	<b>4</b> : grey - <b>5</b> : yellow - <b>6</b> : red - <b>7/1</b> : white
		<b>9</b> : orange

### MARKING

- By engraving on flat or curved brass actuator (stainless steel on request)
- by hot stamping on flat thermoplastic actuator

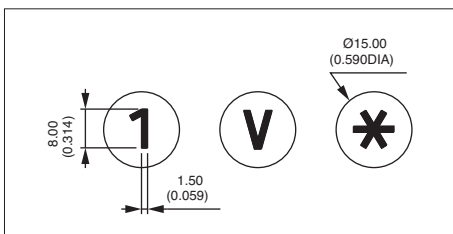

Select an option from each of the two tables below.

TYPE OF MARKING	
CODE	TYPE
<b>0 to 9</b>	Numbers 0 to 9
<b>X</b>	Symbol *
<b>Y</b>	Symbol #
<b>A to N</b>	Letters A to N
<b>P to W</b>	Letters P to W
<b>0</b>	Letter O

Letter O : same code and same design as number 0.  
For special symbols, consult factory.  
Minimum order : 500 pieces

COLOUR OF MARKING	
CODE	COLOUR
<b>Brass actuator</b>	
<b>0 (standard)</b>	Same as finish
<b>2</b>	Black
Note : a finished product supplied in version "0" cannot be modified to version "2".	
<b>Thermoplastic actuator</b>	
<b>2</b>	Black
<b>7</b>	White

### SEALING

Blank No sealing

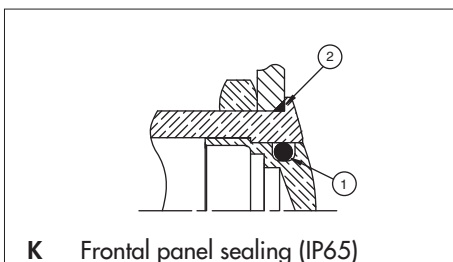

**K** Frontal panel sealing (IP65)

- ① internal gasket
- ② external gasket

B2



# AV series

## Security pushbutton switches Ø 22 mm (.866)

With illuminated ring - momentary (NC/NO)

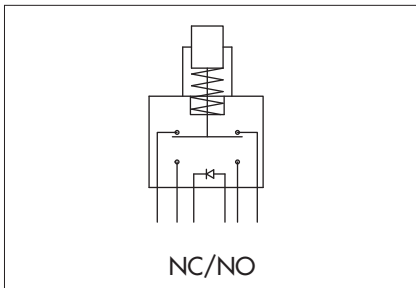
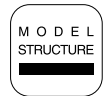

### ORDER FORMAT

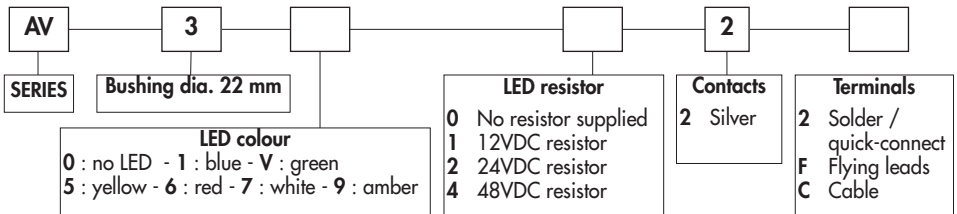

### SPECIFICATIONS

- Travel : 2 mm ± 0,3 mm (.003)
  - Max. current/voltage rating with resistive load : 1A 30VDC
  - LED voltage : 12VDC, 24VDC or 48VDC (If not supplied by APEM, a resistor must be series-connected by the user)\*\*
  - Initial contact resistance : 100 mΩ max.
  - Insulation resistance : 10 MΩ min. at 500VDC
  - Dielectric strength : 500 Vrms 50 Hz min. between terminals  
1.000 Vrms 50 Hz min. between terminals and frame
  - Electrical life : 250.000 cycles at full load
  - Operating force : 5N ± 2N
  - Torque : 5 Nm min.- 14 Nm max. applied to nut
  - Panel thickness : 1 (.039) to 6 mm (.236) max.
  - Low level or mechanical life : 1.000.000 cycles
  - Operating temperature : -20°C to +55°C
  - Hand soldering : 350°C, 5 seconds max.
  - Packaging unit : flying lead/cable models : 1 piece - other models : 40 pieces
- \*\* Resistor value =  $\frac{\text{supply voltage} - \text{LED forward voltage}}{\text{LED forward current}}$

### MATERIALS

- Case : polyamide, glass filled
- Contacts : silver
- Bushing : see next page
- Actuator : see next page
- Elastomeric membrane : silicone
- LED

### CUT-OUT

- Panel cut-out : Ø 22,2 mm (.874)
- Min. pitch for matrix mounting : 30 mm x 30 mm (1.181x1.181)

To order a product, select a basic model below and add the desired LED colour and voltage. Then select the desired options on next page.

### Flat actuator - solder lug terminals



Illuminated (select LED colour above) \*  
**AV3•022**

Non-illuminated  
**AV30022**

\* No LED resistor supplied on this model.

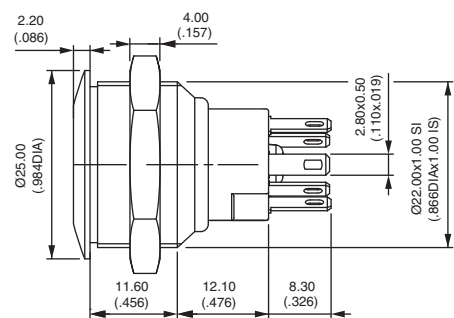
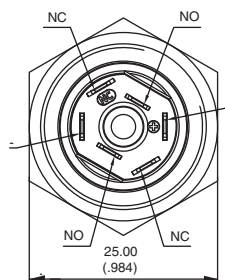

Hex nut 25 (.984) across flats

### Flat actuator - flying lead terminals



Illuminated (select LED colour & resistor above)  
**AV3••2F**

Non-illuminated  
**AV3002F**

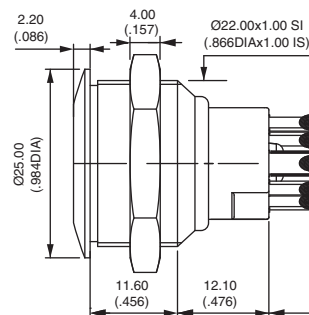

Hex nut 25 (.984) across flats

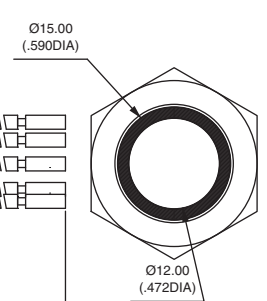

Wire colours : black: NC, orange: NO, red: LED anode (+), blue : LED cathode (-)



# AV series

## Security pushbutton switches Ø 22 mm (.866)

With illuminated ring - momentary changeover (NC/NO)

### Flat actuator - cable terminals

Hex nut 25 (.984) across flats



Illuminated (select colour & resistor)  
**AV3••2C**

Non-illuminated  
**AV3002C**

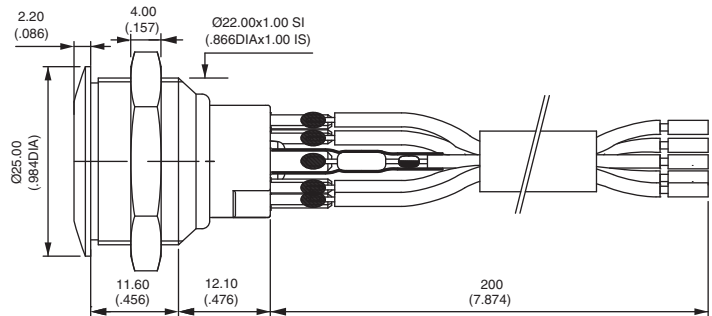

After selecting basic model No., fill in last 5 boxes with desired options.

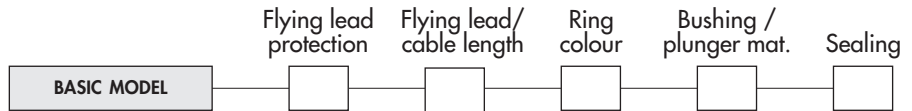

B2

### FLYING LEAD PROTECTION

- 0 No protection and/or no flying leads
- 1 Heat-shrink sleeves
- 2 Tube + epoxy

### WIRE/CABLE LENGTH

- 000 No flying leads / no cable
- 020 Length 20 cm (7.874) - standard
- XXX Length in centimeters

### RING COLOURS

CODE	COLOUR	CODE	COLOUR
1	Blue	6	Red
2	Black *	7	Opal white (std)
3	Green	8	Translucent
4	Grey *	9	Orange
5	Yellow		

\* non-illuminated only

### BUSHING/PLUNGER MATERIALS

CODE	BUSHING	ACTUATOR
00	Brass, nickel plated	Brass, nickel plated
40	Stainless steel 303	Stainless steel 303
4A	Stainless steel 304	Stainless steel 304
4B	Stainless steel 316	Stainless steel 316

Other : on request.

### SEALING

Blank No sealing

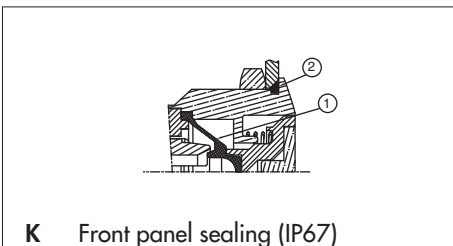

- ① internal membrane
- ② external gasket





# AV series

Security pushbutton switches Ø 22 mm (.866)

*Illuminated and non-illuminated - latching*

## Straight PC terminals

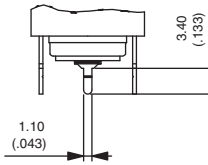

Replace 2 with 4 at the end of the model numbers shown on previous page.

## Quick-connect terminals

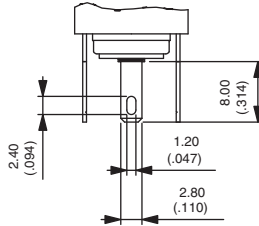

Replace 2 with 8 at the end of the model numbers shown on previous page.

B2

After selecting basic model number, fill in last 2 boxes with desired options.

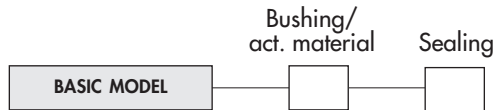

## BUSHING/ACTUATOR MATERIALS

CODE	BUSHING	ACTUATOR
00 (std)	Nickel plated brass	Nickel plated brass
10	Nickel plated brass	Stainless steel
40	Stainless steel	Stainless steel
50	Stainless steel	Nickel plated brass

## SEALING

Blank No sealing

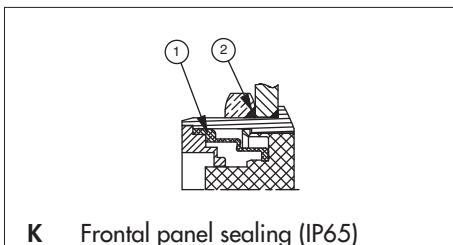

- ① elastomeric membrane
- ② external gasket



# AV series

Security pushbutton switches Ø 22 mm (.866) or 24 mm (.944) with large actuator

Momentary (combined NC+NO)

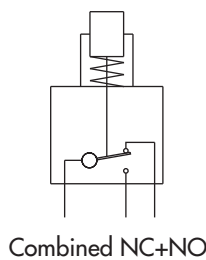

### ORDER FORMAT

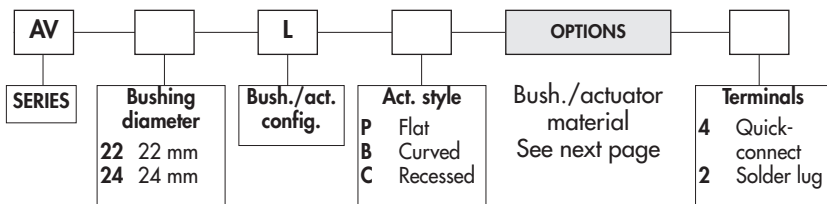

### SPECIFICATIONS

- Max. current/voltage rating with resistive load : 5A 250VAC
- Initial contact resistance : 100 mΩ max.
- Insulation resistance : 1.000 MΩ min. at 500VDC
- Dielectric strength : 2.000 Vrms 50 Hz min. between terminals and frame
- Electrical life : 1.000.000 cycles at 1A 250VAC  
100.000 cycles at full load
- Torque : 5 Nm min.- 14 Nm max. applied to nut
- Panel thickness : 1 (.039) to 6 mm (.236) max.
- Operating temperature : -20°C to +55°C
- Low level or mechanical life : 3.000.000 cycles
- Front panel sealing : IP65
- Hand soldering : 300°C, 5 sec. max.
- Packaging unit : 20 pieces (except black chrome plated : 16 pieces)

### MATERIALS

- Case : polyester, glass filled
- Contacts : silver/nickel alloy
- Bushing and actuator : see next page.

### CUT-OUT

- Panel cut-out : Ø 22,2 mm (.874) or Ø 24,2 mm (.952)
- Min. pitch for matrix mounting : 30 mm x 30 mm (1.181x1.181) or 33 mm x 33 mm (1.299x1.299)

B2

To order a product, select a basic model below or on next page and add the desired bushing/actuator materials.

### BASIC MODEL

#### Flat actuator - AV22LP



- Quick-connect terminals  
**AV22LP••4**
- Solder lug terminals  
**AV22LP••2**

→ O-ring

Hex nut 25 (.984) across flats

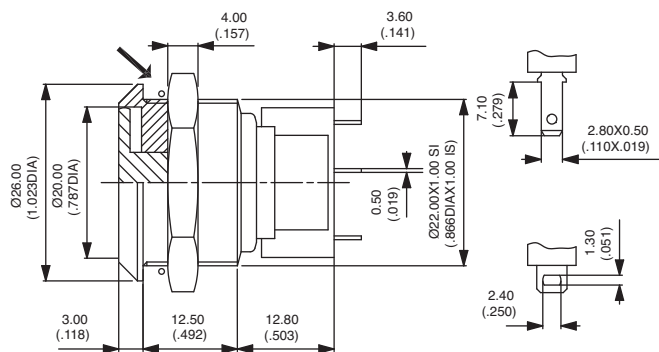

#### Curved actuator - AV22LB

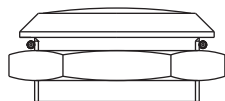

- Quick-connect terminals  
**AV22LB••4**
- Solder lug terminals  
**AV22LB••2**

#### Recessed actuator - AV22LC

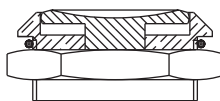

- Quick-connect terminals  
**AV22LC••4**
- Solder lug terminals  
**AV22LC••2**



# AV series

Security pushbutton switches Ø 22 mm (.866) or 24 mm (.944) with large actuator

Momentary (combined NC+NO)

## BASIC MODEL

### Flat actuator - low profile - AV24LP



Quick-connect terminals  
**AV24LP••4**



Solder lug terminals  
**AV24LP••2**



→ O-ring

Hex nut 27 (1.062) across flats

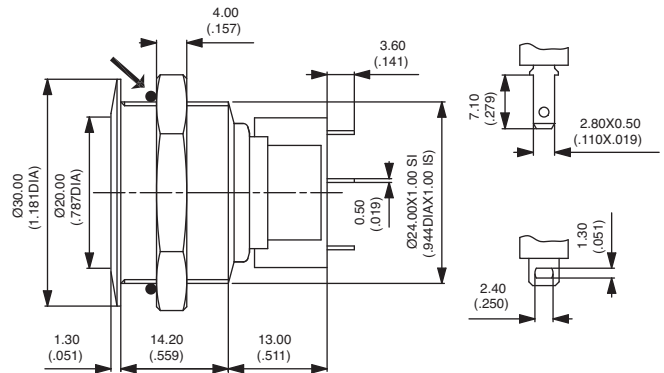

### Curved actuator - AV24LB

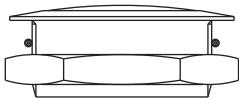

Quick-connect terminals  
**AV24LB••4**  
Solder lug terminals  
**AV24LB••2**

### Recessed actuator - AV24LC

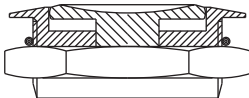

Quick-connect terminals  
**AV24LC••4**  
Solder lug terminals  
**AV24LC••2**

## BUSHING/ACTUATOR MATERIALS

### Models with non-anodized actuator

CODE	BUSHING	ACTUATOR
40 (standard)	Stainless steel	Stainless steel
20	Chrome plated brass	Chrome plated brass

### Models with anodized actuator

CODE	BUSHING	ACTUATOR COLOUR
1•	Black chrome plated brass	Replace • with one of the following codes : 1 : blue - 2 : black - 3 : pale green - 3F : dark green - 4 : natural - 5 : gold yellow 6 : red - 6B : maroon
2•	Chrome plated brass	
4•	Stainless steel	

B2

# AV series

## Mushroom head security pushbutton switches Ø 22 mm (.866)

Momentary (combined NC+NO)

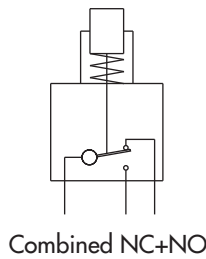
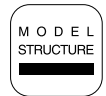

### ORDER FORMAT

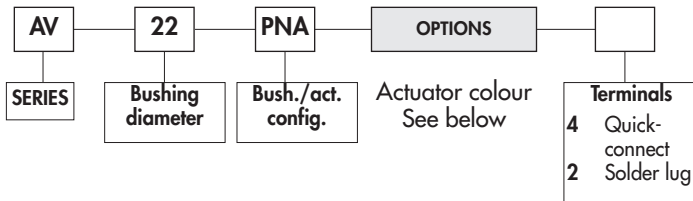

### SPECIFICATIONS

- Max. current/voltage rating with resistive load : 5A 250VAC
- Initial contact resistance : 100 mΩ max.
- Insulation resistance : 1.000 MΩ min. at 500VDC
- Dielectric strength : 2.000 Vrms 50 Hz min. between terminals and frame
- Electrical life : 1.000.000 cycles at 1A 250VAC  
50.000 cycles at full load
- Torque : 5 Nm min.- 14 Nm max. applied to nut
- Panel thickness : 1 (.039) to 6 mm (.236) max.
- Operating temperature : -20°C to +55°C
- Low level or mechanical life : 1.000.000 cycles
- Front panel sealing : IP65
- Hand soldering : 300°C, 5 sec. max.
- Packaging unit : 16 pieces

### MATERIALS

- Case : polyester, glass filled
- Contacts : silver/nickel alloy
- Bushing : brass, nickel plated
- Actuator : aluminium, anodized

### CUT-OUT

- Panel cut-out : Ø 22,2 mm (.874)
- Min. pitch for matrix mounting : 30 mm x 30 mm (1.181x1.181)

To order a product, select a basic model below and add the desired actuator colour.

### BASIC MODEL

#### Mushroom head actuator - AV22PNA



Quick-connect terminals  
**AV22PNA•4**

Solder lug terminals  
**AV22PNA•2**



→ O-ring

Hex nut 25 (.984) across flats

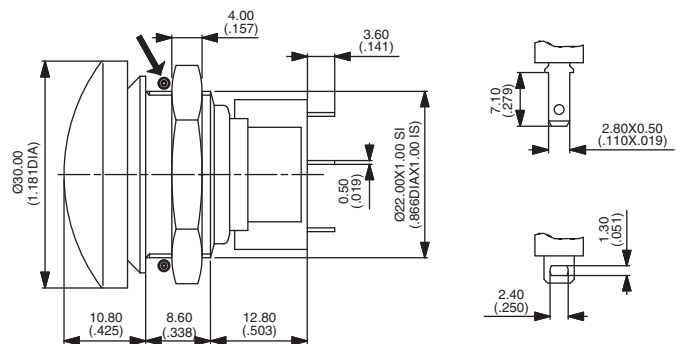

### ACTUATOR ANODIZATION COLOURS

1 : blue - 2 : black - 3 : pale green - 3F : dark green - 4 : natural - 5 : gold yellow - 6 : red - 6B : maroon

## X-ON Electronics

Largest Supplier of Electrical and Electronic Components

*Click to view similar products for [Pushbutton Switches](#) category:*

*Click to view products by [Apem](#) manufacturer:*

Other Similar products are found below :

[8940K2012](#) [LW1L-M1C10V-A](#) [LW1L-M1C70-A](#) [LW2L-A1C20M-GD](#) [LW2L-M1C20M-A](#) [60324L](#) [M22-D-R-GB0/K11](#) [M7E-HRN2](#)  
[67021K512](#) [67081K512X](#) [701PB580](#) [7190K101](#) [7199K101](#) [810K12910](#) [810KSV30B](#) [MML21EA2ADK](#) [MML21KA3ABK](#)  
[MML23KA3AC05K-001](#) [MML23KW3AA01W](#) [8418K2](#) [8442K3](#) [8450K1](#) [860K11911T01A](#) [861901](#) [861K11911T01A07](#)  
[861K13810T00A14](#) [861K13911](#) [8646AB6X718UL](#) [8646ABUL](#) [9001KXRK](#) [907AYY100](#) [PMHD155A1](#) [95-313.000](#)  
[9533CD4+U574+U4922](#) [95-414.000](#) [99-450.837](#) [99-453.837](#) [PV3H2B0NN-341](#) [1203MRA](#) [A22NZBGANGA](#) [A22NZBMMNGA](#)  
[A22NZBNANGA](#) [A22NZMPATRA](#) [A2PMA1X03EC56](#) [A3A-5123-02](#) [A3A-7140](#) [A3A-7310](#) [A3A-7340](#) [A3U-TMW-A2C-5M](#) [A595](#)