

# AV series

Tactile security pushbutton switches with overmolded actuator • Ø 19 or 22 mm



## DISTINCTIVE FEATURES

- Tactile feedback
- Illuminated or non-illuminated
- Momentary (NO)
- Overmolded marking available



## ENVIRONMENTAL SPECIFICATIONS

- Front panel sealing : IP67 or IP69K according to IEC 60529
- Operating temperature : -30 °C to +70 °C (-22 °F to +158 °F)



## ELECTRICAL SPECIFICATIONS

- Max. current/voltage rating with resistive load : 50 mA 24 VDC
- Initial contact resistance : 100 mΩ max.
- Insulation resistance : 1.000 MΩ min. at 500 VDC
- Dielectric strength : 500 Vrms 50 Hz min. between terminals  
2,000 Vrms 50 Hz min. between terminals and frame
- Electrical life : 1,000,000 cycles at full load

### LED COMPONENT SPECIFICATIONS

LED color	Forward current	Typ. forward voltage	Max. forward voltage
Blue	20 mA	3.3 V	3.8 V
Green	20 mA	4 V	4.5 V
Yellow	20 mA	2 V	2.5 V
Red	20 mA	1.95 V	2.5 V
White	20 mA	3.3 V	4 V
Amber	20 mA	2.3 V	2.8 V
Red / green	20 mA	1.85 V / 2.2 V	2.5 V

A resistor must be series-connected by the user  
 Resistor value =  $\frac{\text{supply voltage} - \text{LED forward voltage}}{\text{LED forward current}}$

The company reserves the right to change specifications without notice.



# AV series

Tactile security pushbutton switches with overmolded actuator •  
 Ø 19 or 22 mm



## GENERAL SPECIFICATIONS

- Travel : 0.7 mm (.027) ± 0.1 mm (.003)
- Operating force : 7 N ± 2N - Sealing option K will increase the operating force.
- Torque : 5 Nm min.- 14 Nm max. applied to nut
- Panel thickness : 1 (.039) to 6 mm (.236) max.
- Hand soldering : 270 °C (518 °F), 3 sec. max.



## MATERIALS

- Case : PA46 UL94-V0
- Terminals : brass, gold plated
- Contacts : gold plated dome
- Bushing : see following pages
- Actuator : stainless steel, with thermoplastic overmolding
- LED

APEM products may be recycled at end-of-life for the re-claiming of valuable metal components.



## ELECTRICAL FUNCTIONS

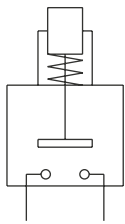

Function 3 (NO)



## MOUNTING

- Panel cut-out : Ø 19.2 mm (.755), or Ø 22.2 mm (.874)
- Min. pitch for matrix mounting :  
 30 mm x 30 mm (1.181x1.181)

Tactile security pushbutton switches with overmolded actuator • Ø 19 or 22 mm



## BUILD YOUR PART NUMBER

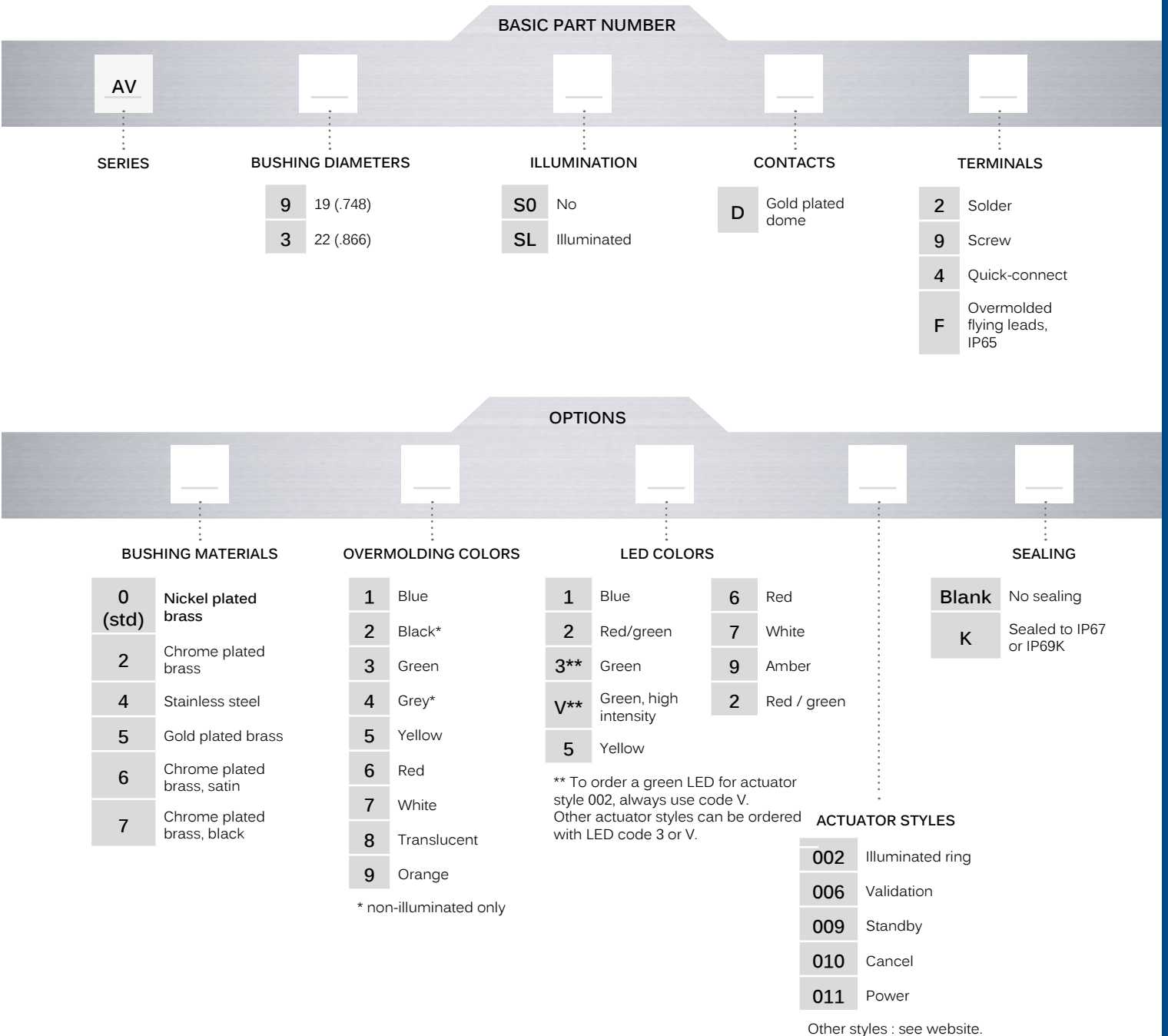

## ABOUT THIS SERIES

On the following pages, you will find successively basic part numbers of switches and options in the same order as in above chart.

- Notice:** please note that not all combinations of above numbers are available. Refer to the following pages for further information.
- Mounting accessories:** standard hardware supplied : 1 hex nut. Standard and special hardware is presented in the "Hardware" section of website.

# AV series

Tactile security pushbutton switches with overmolded actuator •  
 Ø 19 or 22 mm

## BUSHING Ø 19 (.748) - FLAT ACTUATOR SOLDER LUG TERMINALS

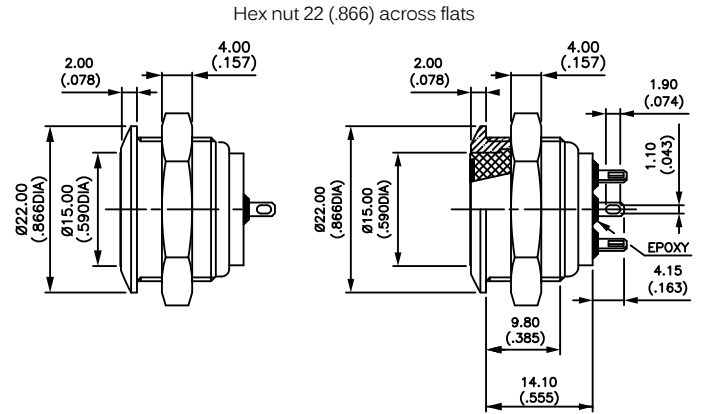
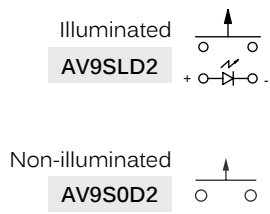

## BUSHING Ø 19 (.748) - FLAT ACTUATOR SCREW TERMINALS

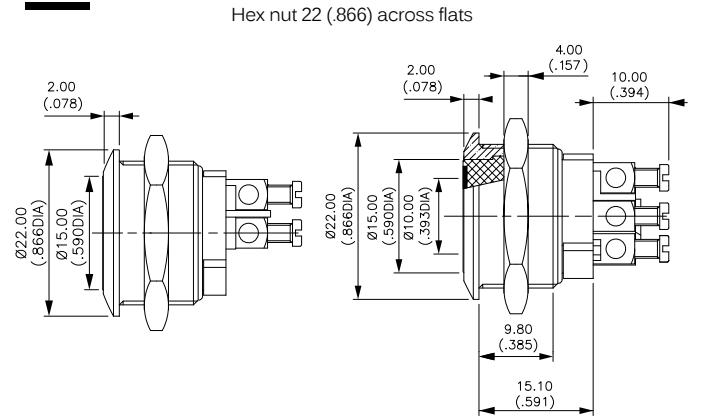
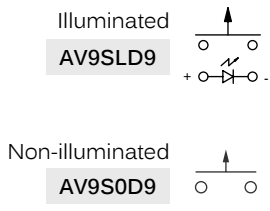

## BUSHING Ø 22 (.866) - FLAT ACTUATOR SOLDER LUG TERMINALS

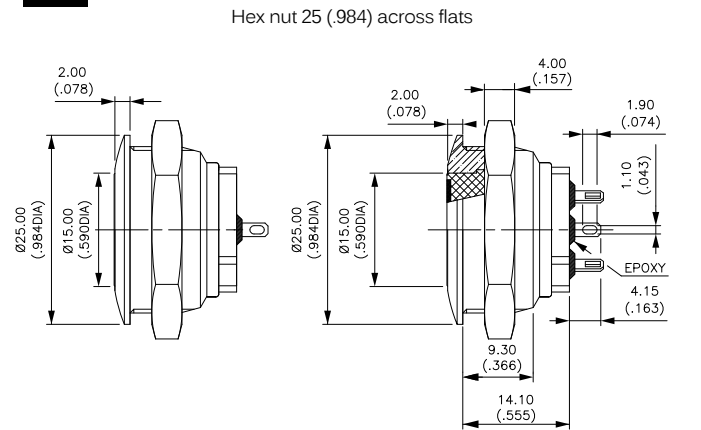
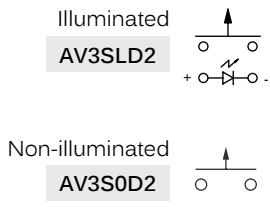

## BUSHING Ø 22 (.866) - FLAT ACTUATOR SCREW TERMINALS

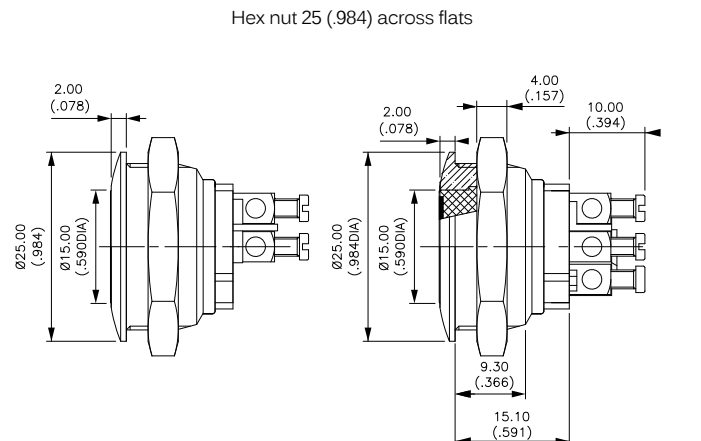
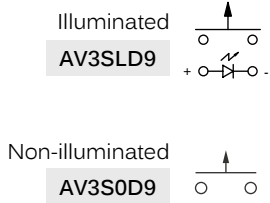

# AV series

Tactile security pushbutton switches with overmolded actuator •  
 Ø 19 or 22 mm

## BUSHING MATERIALS

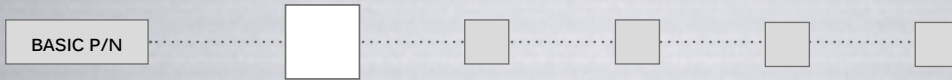

- 0 (std) Nickel plated brass
- 2 Chrome plated brass
- 4 Stainless steel
- 5 Gold plated brass
- 6 Chrome plated brass, satin
- 7 Chrome plated brass, black

## OVERMOLDING COLORS



- 1 Blue \* non-illuminated only
- 2 Black\*
- 3 Green
- 4 Grey\*
- 5 Yellow
- 6 Red
- 7 White
- 8 Translucent
- 9 Orange

## LED COLORS

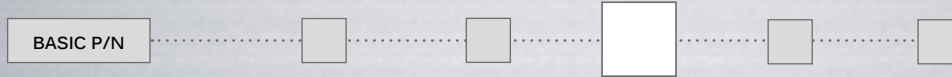

- Blank No LED
  - 1 Blue
  - 2 Red / green
  - 3\*\* Green
  - V\*\* Green, high intensity
  - 5 Yellow
  - 6 Red
  - 7 White
  - 9 Amber
- \*\* To order a green LED for actuator style 002, always use code V.  
 Other actuator styles can be ordered with LED code 3 or V.

## ACTUATOR STYLES



The ring and symbols are obtained by photochemical engraving of a stainless steel insert.  
 The insert is then overmolded in the desired color.

The following actuator styles are available. For other types, consult factory.



001  
Illuminated  
ring and disc



002  
Illuminated  
ring



003  
Arrow



004  
Loudspeaker  
OFF



005  
Opening



006  
Validation



008  
Closing



009  
Standby



010  
Cancel



011  
Power

# AV series

Tactile security pushbutton switches with overmolded actuator •  
 Ø 19 or 22 mm

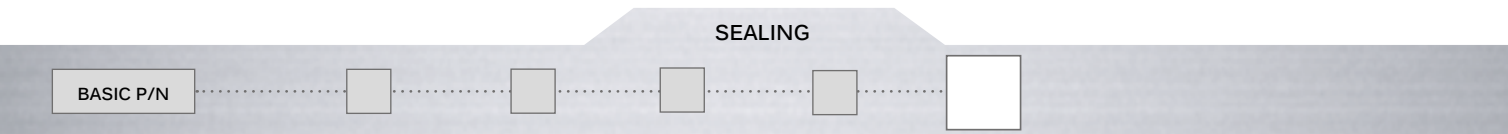

- Blank No sealing
- K Front panel sealing to IP67 or IP69K

OPTION K - FRONT PANEL SEALING IP67

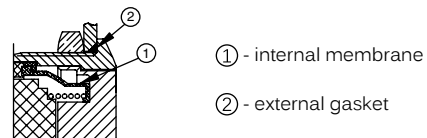

OPTION K - FRONT PANEL SEALING IP69K

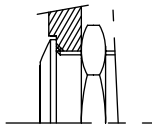

## X-ON Electronics

Largest Supplier of Electrical and Electronic Components

*Click to view similar products for [Pushbutton Switches](#) category:*

*Click to view products by [Apem](#) manufacturer:*

Other Similar products are found below :

[8940K2012](#) [LW1L-M1C10V-A](#) [LW1L-M1C70-A](#) [LW2L-A1C20M-GD](#) [LW2L-M1C20M-A](#) [60324L](#) [M22-D-R-GB0/K11](#) [M7E-HRN2](#)  
[67021K512](#) [67081K512X](#) [701PB580](#) [7190K101](#) [7199K101](#) [810K12910](#) [810KSV30B](#) [MML21EA2ADK](#) [MML21KA3ABK](#)  
[MML23KA3AC05K-001](#) [MML23KW3AA01W](#) [8418K2](#) [8442K3](#) [8450K1](#) [860K11911T01A](#) [861901](#) [861K11911T01A07](#)  
[861K13810T00A14](#) [861K13911](#) [8646AB6X718UL](#) [8646ABUL](#) [9001KXRK](#) [907AYY100](#) [PMHD155A1](#) [95-313.000](#)  
[9533CD4+U574+U4922](#) [95-414.000](#) [99-450.837](#) [99-453.837](#) [PV3H2B0NN-341](#) [1203MRA](#) [A22NZBGANGA](#) [A22NZBMMNGA](#)  
[A22NZBNANGA](#) [A22NZMPATRA](#) [A2PMA1X03EC56](#) [A3A-5123-02](#) [A3A-7140](#) [A3A-7310](#) [A3A-7340](#) [A3U-TMW-A2C-5M](#) [A595](#)