

DS-DP-DA series

DIP switches

Distinctive features and specifications

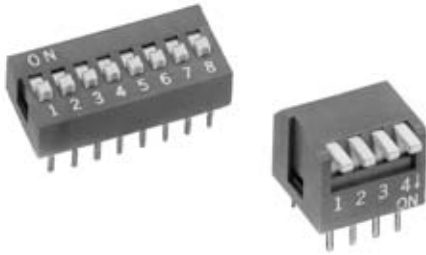

- Standard, piano and right angle models
- 2 to 12 positions
- Top tape sealing option

ELECTRICAL SPECIFICATIONS

- Current/voltage rating :
 - non-switching : 100mA 50VDC
 - switching : 50mA 24VDC
- Contact resistance (at 100mA) :
 - 50mΩ max. at initial
 - 100mΩ after life test
- Insulation resistance (at 100VDC +/-15V) :
 - 100 MΩ min. between adjacent terminals
- Dielectric strength : 500VDC for one minute
- Capacitance : 5 pF between adjacent terminals
- Circuit : single pole, single throw
- Electrical life : 2.000 cycles min. per switch

MATERIALS

- Case, UL94-V0, glass fiber filled PBT, black
- Cover : UL94-V0, glass fiber filled PBT, red
- Actuator : UL94-V0, glass fiber filled PBT, white
- Terminals/contacts : gold over nickel plated phosphor bronze
- Terminal seal : epoxy
- Tape seal : polyester film

GENERAL SPECIFICATIONS

- Operating force : DP models : 4N - DS/DA models : 8N
- Travel : 2 mm (.078)
- Mechanical life : 5.000 cycles min. per switch
- Vibration test : MIL-STD-202F method 201A
- Shock test : MIL-STD-202F method 213B, condition A
- Operating temperature : -20°C to +70°C

RECOMMENDED SOLDERING AND CLEANING PROCESSES

- Hand soldering : 320°C max. for 2 seconds max. (30 watt iron max.)
- Wave soldering : 260°C max. for 5 seconds max.
- Force rinse, high agitation or triple bath cleaning method (**with tape seal, option T**) : freon TF or TE. When vapor methods are used, do not subject switch to solvents above 51°C.

Note : keep switches in "OFF" position during soldering and cleaning for best results.

Dimensions : first dimensions are in mm while inches are shown as bracketed numbers.



Packaging unit : standard IC tubes - Quantities depending on model. See table below.

DS/DSR	Quantity	DS-T/DSR-T	Quantity	DA	Quantity	DA-T	Quantity	DP/DPL	Quantity	DP-T/DPL-T	Quantity
DS(R)-02	72	DS(R)-02T	72	DA-02	73	DA-02T	70	DP(L)-02	70	DP(L)-02T	65
DS(R)-03	51	DS(R)-03T	51	DA-03	52	DA-03T	50	DP(L)-03	50	DP(L)-03T	49
DS(R)-04	40	DS(R)-04T	40	DA-04	40	DA-04T	39	DP(L)-04	39	DP(L)-04T	39
DS(R)-05	32	DS(R)-05T	32	DA-05	33	DA-05T	32	DP(L)-05	32	DP(L)-05T	32
DS(R)-06	27	DS(R)-06T	27	DA-06	28	DA-06T	28	DP(L)-06	27	DP(L)-06T	27
DS(R)-07	24	DS(R)-07T	24	DA-07	24	DA-07T	24	DP(L)-08	21	DP(L)-08T	21
DS(R)-08	21	DS(R)-08T	21	DA-08	21	DA-08T	21	DP(L)-10	17	DP(L)-10T	17
DS(R)-09	19	DS(R)-09T	19	DA-09	19	DA-09T	19	DP(L)-12	14	DP(L)-12T	14
DS(R)-10	17	DS(R)-10T	17	DA-10	17	DA-10T	17				
DS(R)-12	14	DS(R)-12T	14	DA-12	14	DA-12T	14				

DS/DSR series

Standard DIP switches

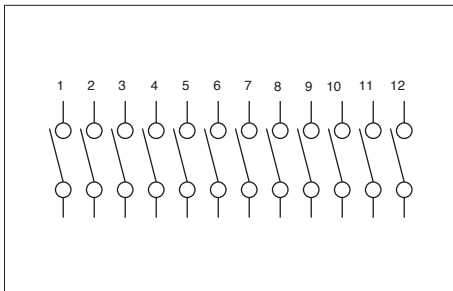

- Raised or recessed actuator
- 2 to 12 positions

MODEL STRUCTURE



Raised actuator : DS



Model No	No. pos.	Dim "A"	Dim. "B"
DS-02	2	6,60 (.259)	2,54 (.100)
DS-03	3	9,14 (.359)	5,08 (.200)
DS-04	4	11,68 (.459)	7,62 (.300)
DS-05	5	14,22 (.559)	10,16 (.400)
DS-06	6	16,76 (.659)	12,70 (.500)
DS-07	7	19,30 (.759)	15,24 (.600)
DS-08	8	21,84 (.859)	17,78 (.700)
DS-09	9	24,38 (.959)	20,32 (.800)
DS-10	10	26,92 (1.059)	22,86 (.900)
DS-12	12	32,00 (1.259)	27,94 (1.100)

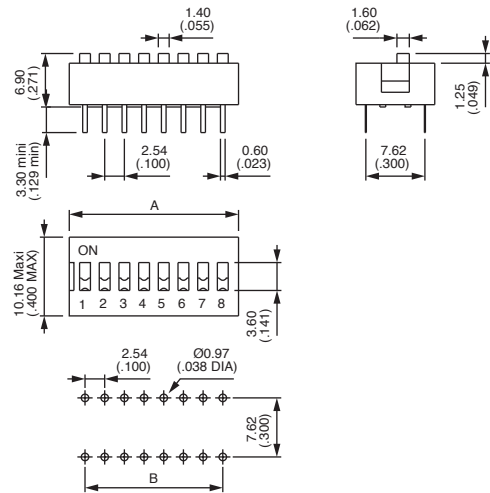

Top tape sealed : add "T" after model number.

Recessed actuator : DSR



Model No	No. pos.	Dim "A"	Dim. "B"
DSR-02	2	6,60 (.259)	2,54 (.100)
DSR-03	3	9,14 (.359)	5,08 (.200)
DSR-04	4	11,68 (.459)	7,62 (.300)
DSR-05	5	14,22 (.559)	10,16 (.400)
DSR-06	6	16,76 (.659)	12,70 (.500)
DSR-07	7	19,30 (.759)	15,24 (.600)
DSR-08	8	21,84 (.859)	17,78 (.700)
DSR-09	9	24,38 (.959)	20,32 (.800)
DSR-10	10	26,92 (1.059)	22,86 (.900)
DSR-12	12	32,00 (1.259)	27,94 (1.100)

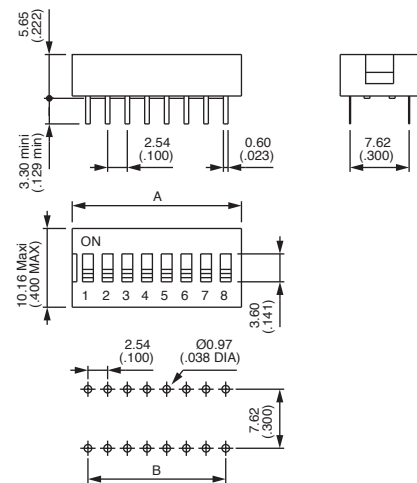

Top tape sealed : add "T" after model number.

DP/DPL series

Piano DIP switches

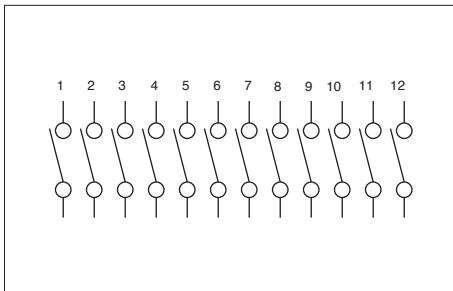

- Short or long actuator
- 2 to 12 positions

Note : Push down for "ON" is our standard type.
Push down for "OFF" is also available on special order, consult factory.

MODEL STRUCTURE



Short actuator : DP

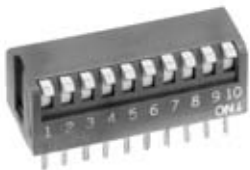

Model No	No. pos.	Dim "A"	Dim. "B"
DP-02	2	6,63 (.261)	2,54 (.100)
DP-03	3	9,17 (.361)	5,08 (.200)
DP-04	4	11,71 (.461)	7,62 (.300)
DP-05	5	14,25 (.561)	10,16 (.400)
DP-06	6	16,8 (.661)	12,70 (.500)
DP-08	8	21,87 (.861)	17,78 (.700)
DP-10	10	26,95 (1.061)	22,86 (.900)
DP-12	12	32,03 (1.261)	27,94 (1.100)

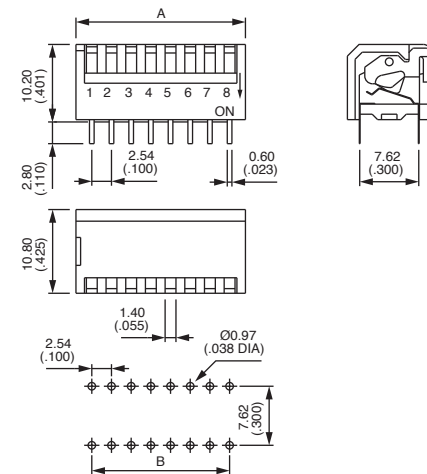

Top tape sealed : add "T" after model number.

Long actuator : DPL



Model No	No. pos.	Dim "A"	Dim. "B"
DPL-02	2	6,63 (.261)	2,54 (.100)
DPL-03	3	9,17 (.361)	5,08 (.200)
DPL-04	4	11,71 (.461)	7,62 (.300)
DPL-05	5	14,25 (.561)	10,16 (.400)
DPL-06	6	16,8 (.661)	12,70 (.500)
DPL-08	8	21,87 (.861)	17,78 (.700)
DPL-10	10	26,95 (1.061)	22,86 (.900)
DPL-12	12	32,03 (1.261)	27,94 (1.100)

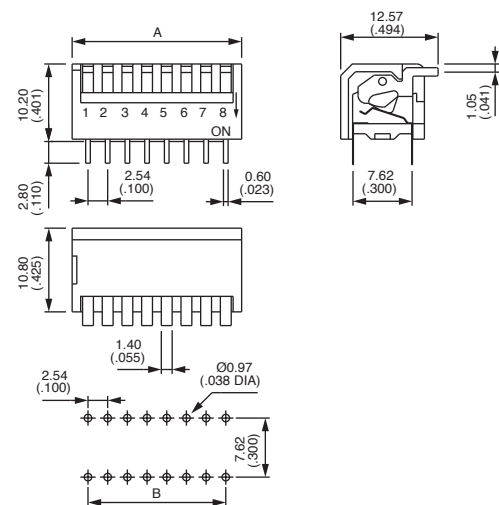

Top tape sealed : add "T" after model number.



DA series

Right angle DIP switches

- 2 to 12 positions

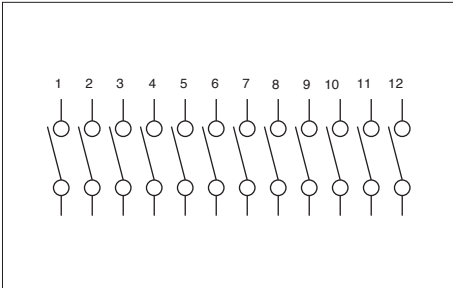

**MODEL
STRUCTURE**



Raised actuator : DA



Model No	No. pos.	Dim "A"	Dim. "B"
DA-02	2	6,60 (.259)	2,54 (.100)
DA-03	3	9,14 (.359)	5,08 (.200)
DA-04	4	11,68 (.459)	7,62 (.300)
DA-05	5	14,22 (.559)	10,16 (.400)
DA-06	6	16,76 (.659)	12,70 (.500)
DA-07	7	19,30 (.759)	15,24 (.600)
DA-08	8	21,84 (.859)	17,78 (.700)
DA-09	9	24,38 (.959)	20,32 (.800)
DA-10	10	26,92 (1.059)	22,86 (.900)
DA-12	12	32,00 (1.259)	27,94 (1.100)

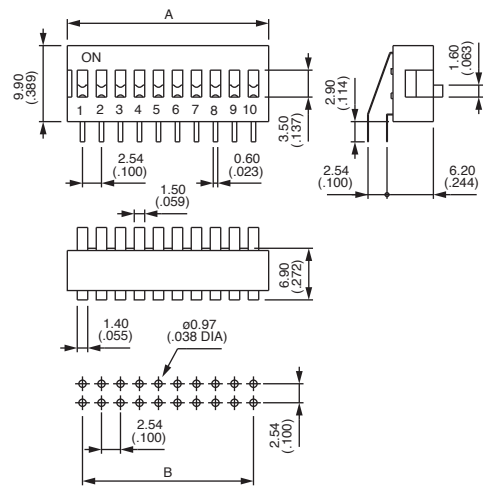

Top tape sealed : add "T" after model number.

F

X-ON Electronics

Largest Supplier of Electrical and Electronic Components

Click to view similar products for [DIP Switches/SIP Switches](#) category:

Click to view products by [Apem](#) manufacturer:

Other Similar products are found below :

[78M03S](#) [79B10T](#) [8136-475G4T](#) [G7G-1A2-CB-DC12](#) [H7CZL8AC100240](#) [A7SS-M](#) [A8CA-201](#) [DRR60016](#) [DRS4016](#) [1825008-1](#) [1825444-1](#) [25.350.0653.0](#) [SBS 5004 TG](#) [SDA10H1BDA](#) [97R06ST](#) [A2C-2A5](#) [1825444-7](#) [ADE08SA04](#) [ADE12S04](#) [192960010](#) [2-1825058-8](#) [25.330.0653.1](#) [25.352.0353.0](#) [CXDRIVEV2X](#) [IKN0600000](#) [IKN0800000](#) [LA2-002-DC24](#) [DBS1003](#) [438872000](#) [DRD10CRAE04](#) [DSR02T](#) [DSS 208 N](#) [E2FMX2D1M1TGJ03M](#) [NDI10H](#) [219-9MSTP](#) [204-6ES](#) [EPM02FV](#) [701521596](#) [NDS08V](#) [76SB05](#) [79A10](#) [TD06H0SK1](#) [Z7.255.9027.0](#) [1-1825058-3](#) [1825428-4](#) [206-8ST-ON](#) [219-10LPSTF](#) [E3ZG6111D03M](#) [G4D212PUSTV2DC5](#) [NDI05H](#)