



The HFX Series I Joystick is designed for precision finger operated applications requiring proportional control and long trouble-free life. Featuring non-contacting Hall effect technology for three million lifecycle performance, the HFX Series I may be specified as a one, two, or three axes joystick. Featuring APEM's core Hall effect technology and patented joystick mechanism, the HFX Series I has been field tested and proven for more than a dozen years. The HFX Series I joystick's compact size, low operational force and high reliability make it ideally suited for clean environment applications including coordinate measuring machines, CCTV equipment and broadcast camera control.



KEY FEATURES

- Hall effect technology
- Precision analog control
- One, two, or three axes operation
- Range of fingertip handle options
- Rated for 3 million lifecycles
- Sealing up to IP68 above panel



HFX series I

First generation Hall effect joysticks

OPTION SELECTION

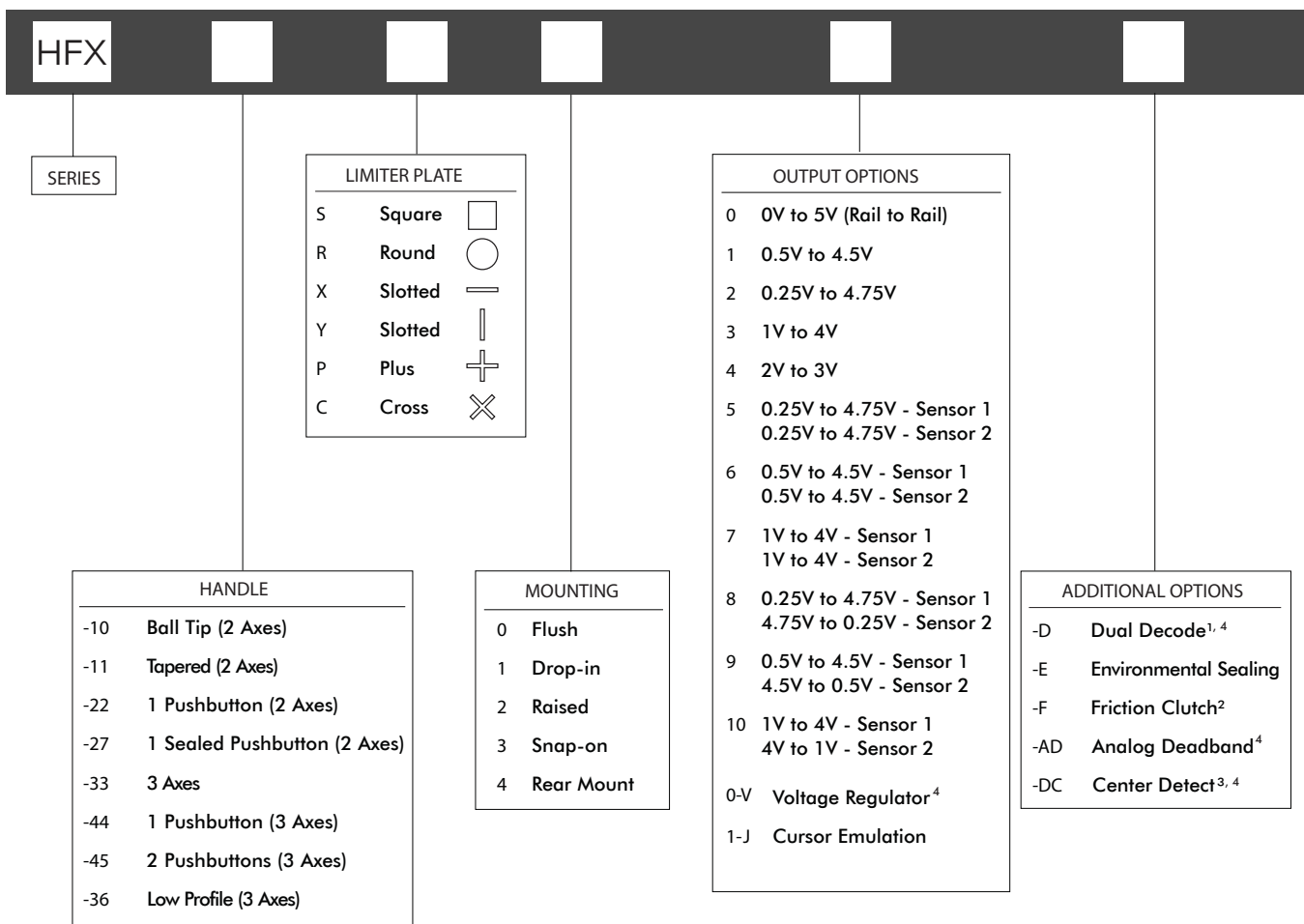

NOTES

1. Dual Decode cannot be used with the Voltage Regulator. Dual Decode requires Output Option 8.
2. Friction Clutch requires limiter plates R, X, or Y.
3. Center Detect requires output Option 1.
4. Depth below panel increases by 10mm (0.394in) for Voltage Regulator, Dual Decode, Analog Deadband, and Center Detect Output Options.



Up to IP68 available.



Mounting accessories. Standard hardware includes: gasket, clamping ring, and four 40-3/4Phil Ph MS SS screws.

HFX series I

First generation Hall effect joysticks

SPECIFICATIONS

MECHANICAL (FOR X, Y AXES)

Break Out Force	-	1.3N (0.3lbf)
Operating Force	-	2.8N (0.63lbf)
Maximum Applied Force	-	200N (45.00lbf)
Mechanical Angle of Movement	-	36° (±18°)
Expected Life	-	3 million cycles
Material	-	Glass filled nylon
Lever Action	-	Single spring omnidirectional

MECHANICAL (FOR Z AXIS)

Break Out Torque	-	0.09N-m (0.80lbf-in)
Operating Torque	-	0.121N-m (1.07lbf-in)
Maximum Allowable Torque	-	0.150N-m (1.33lbf-in)
Hand Mechanical Angle	-	60° (±30°)
Handle Action	-	Spring centering, rotational
Expected Life	-	3 million cycles

ENVIRONMENTAL

Operating Temperature	-	-25°C to 70°C (-13°F to 158°F)
Storage Temperature	-	-40°C to 70°C (-40°F to 158°F)
Sealing (IP)	-	IP65 to IP68*
EMC Immunity Level (V/M)	-	IEC 61000-4-3: 2006
EMC Emissions Level	-	IEC 61000-4-8: 1993/A1: 2000
ESD	-	IEC 61000-4-2: 2008

ELECTRICAL

Sensor	-	Hall effect
Resolution	-	Infinite
Supply Voltage Operating	-	5.00VDC
Reverse Polarity Max	-	-14.5VDC
Overvoltage Max	-	18VDC
Output Voltage	-	See options
Output Impedance	-	6Ω
Current Consumption Max	-	10mA per axis
Return to Center Voltage (No Load)	-	±200mV
Output Ramp	-	See options

NOTES:

- All values are nominal
- Exact specifications may be subject to configuration.
Contact Technical Support for the performance of your specific configuration.
- * Excludes some handle options

HFX series I

First generation Hall effect joysticks

DIMENSIONAL DRAWINGS



Note: The company reserves the right to change specifications without notice.

HFX series I

First generation Hall effect joysticks

DIMENSIONAL DRAWINGS



NOTES:

1. Dimensions are in mm/(inch).
2. Depth below panel increases by 10mm (0.394in) for Voltage Regulator, Dual Decode, Analog Deadband, and Center Detect Output Options.
3. Axes orientation:



DEFAULT WIRE COLOR CODE*

COLOR	FUNCTION	AWG
RED	Vcc or Vdd	28
BLACK	Ground	
BLUE	X Axis	
YELLOW	Y Axis	
GREEN	Z Axis	22
WHITE	Switch Common (optional)	
ORANGE	Switch 1 (optional)	
VIOLET	Switch 2 (optional)	

* - Starting from the strain relief, the leads are 178mm (7in) long, 3.18mm (0.125in) stripped.

HFX series I

First generation Hall effect joysticks

DIMENSIONAL DRAWINGS - continued

PANEL CUTOUT DIMENSIONS

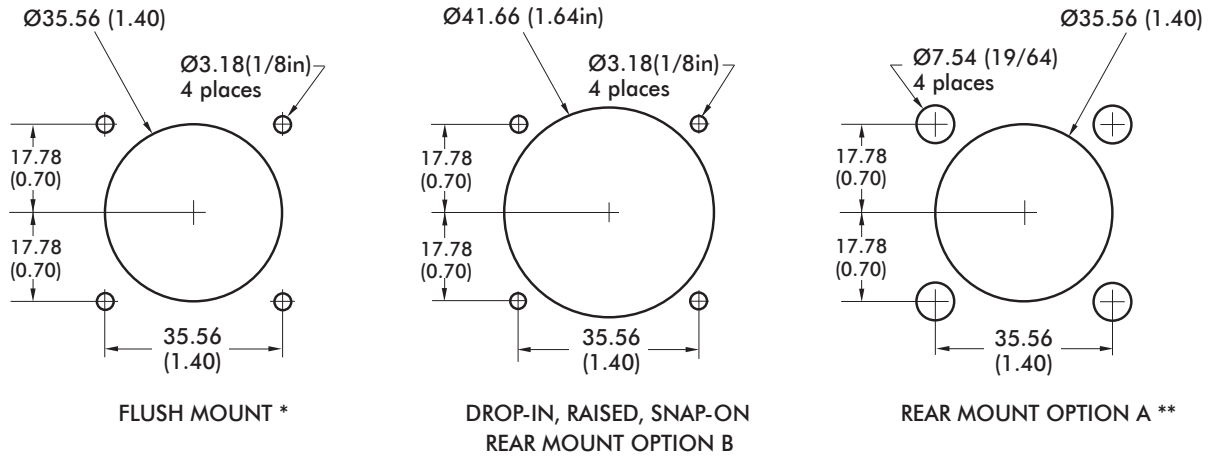

* Not available for Option 11 Handle

** Available only for Option 10, 22, and 27 Handles

MOUNTING OPTIONS

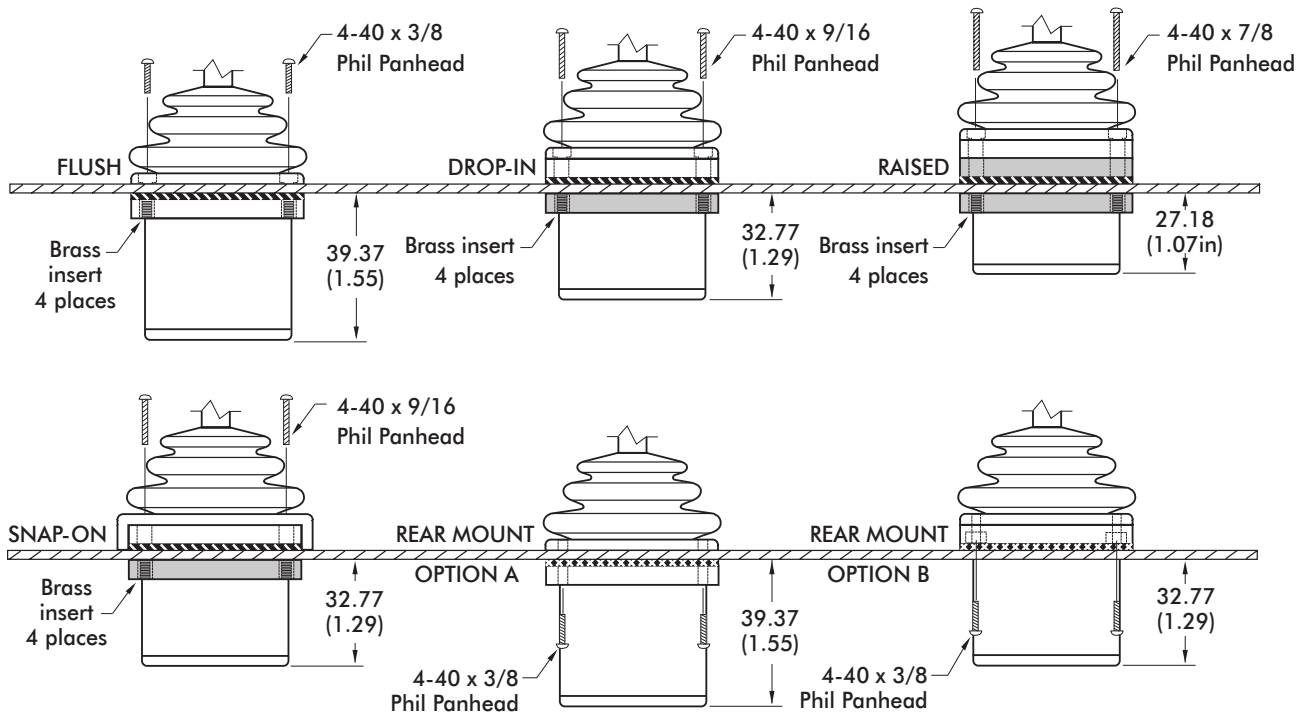

NOTES:

- Dimensions are in mm/(inch).
- The panel thickness can be 1.17mm to 3.17mm (0.046in to 0.125in), except for the Rear Mount Option A, where the maximum panel thickness is 1.6mm (0.063in).
- A panel thickness of 1/16" (1.6mm, 0.063in) was considered for all the below-panel depth values.

HFX series I

First generation Hall effect joysticks

CONFIGURATION OPTIONS

LINEAR OUTPUT OPTIONS

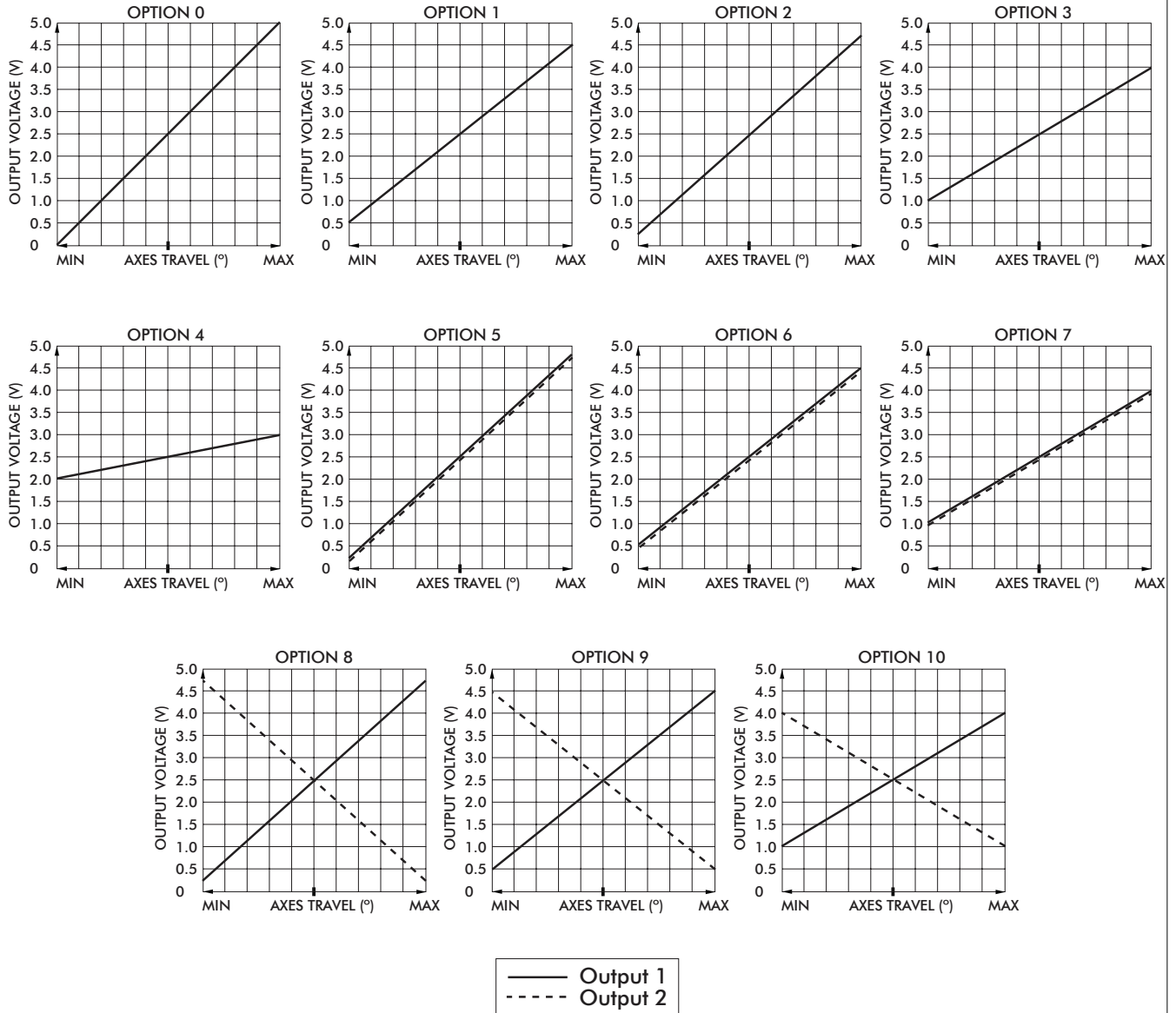

Note: The company reserves the right to change specifications without notice.

HFX series I

First generation Hall effect joysticks

CONFIGURATION OPTIONS - continued

ADDITIONAL OUTPUT OPTIONS

DUAL DECODE

Dual Decode utilizes a microprocessor to monitor two linear opposite-ramp signals for each joystick axis and provides one proportional (0.5VDC – 4.5VDC) and one logical output accordingly. The dual inverted signals are continuously monitored and a logical signal of 0VDC is provided for over-range (>4.5VDC), under-range (<0.5VDC) and signal tracking (sum of both signals equals 4.5V +/-10%) error. A logical signal of 5.0VDC is provided for a properly functioning joystick deflected from center.

APPLICATIONS

Dual Decode provides a center detect function as well as error tracking, making it ideal for high liability, safety critical applications.

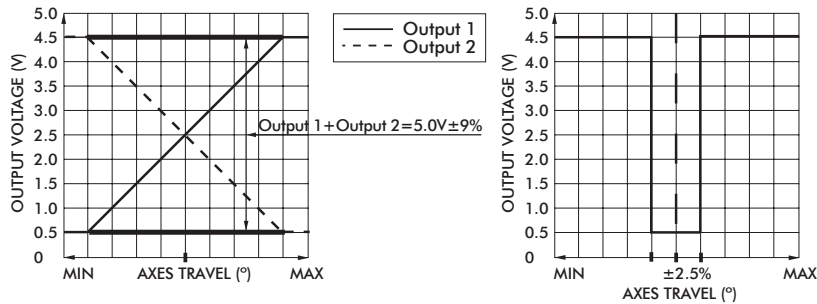

ELECTRICAL SPECIFICATIONS

Supply Power	-	4.5VDC to 5.5VDC
Supply Current	-	30mA + 10mA per axis

WIRING SPECIFICATION

Red wire	-	Customer power supply 4.5VDC-5.5VDC
Black wire	-	Customer power supply ground
Blue wire	-	X axis output
Yellow wire	-	Y axis output
Green wire	-	Z axis output
Blue/White wire	-	X axis dual decode logic output
Yellow/Black wire	-	Y axis dual decode logic output
Green/Black wire	-	Z axis dual decode logic output
White wire	-	Pushbutton common wire
Orange,violet,grey,brown,pink,bl/wt/y/bk,gn/bk,gy/w wire	-	Pushbutton outputs

ANALOG DEADBAND

Analog Deadband utilizes an analog circuit to monitor proportional joystick outputs and enhance return to center accuracy over multiple axes. Specified for joysticks with normally ranged outputs of 0vdc – 5vdc at full axis travel, a constant output of 2.5vdc is provided for the joystick's position +/-2.5° from center.

APPLICATIONS

Analog Deadband effectively eliminates mechanical return-to-center error, making it ideally suited for safety critical applications susceptible to drift and motion control systems lacking center position trim.

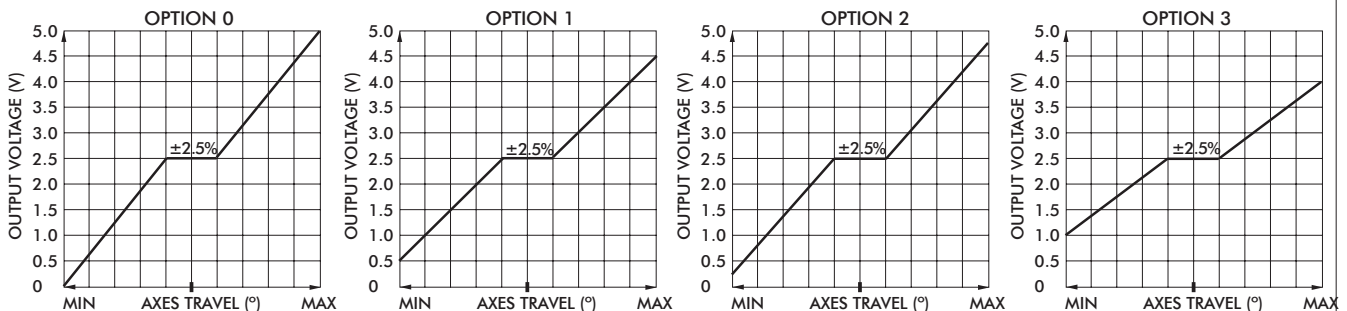

Note: The company reserves the right to change specifications without notice.

HFX series I

First generation Hall effect joysticks

CONFIGURATION OPTIONS - continued

ADDITIONAL OUTPUT OPTIONS

ELECTRICAL SPECIFICATIONS

Supply Power	-	4.5VDC to 5.5VDC
Supply Current	-	10mA per axis

WIRING SPECIFICATION

Red wire	-	Customer power supply 4.5-5.5vdc
Black wire	-	Customer power supply ground
Blue wire	-	X axis output
Yellow wire	-	Y axis output
Green wire	-	Z axis output
White wire	-	Pushbutton common wire
Orange,violet,grey,brown,pink,bl/wt/y/bk,gn/bk,gy/w wire	-	Pushbutton outputs

CENTER DETECT

Center Detect utilizes a microprocessor to monitor joystick output and provides both logic and proportional signals for enhanced operator safety. Specified for a joystick normally ranged 0.5VDC to 4.5VDC, the microprocessor continuously monitors the proportional output and provides HI logic signal (5.0VDC) when moved off center and an LO logical signal (0VDC) for an over-range (>4.5VDC) or under-range (<0.5VDC).

APPLICATIONS

Center Detect is ideal for safety critical applications including master relay control "MRC" for a motion control systems or as a brake release for an overhauling load.

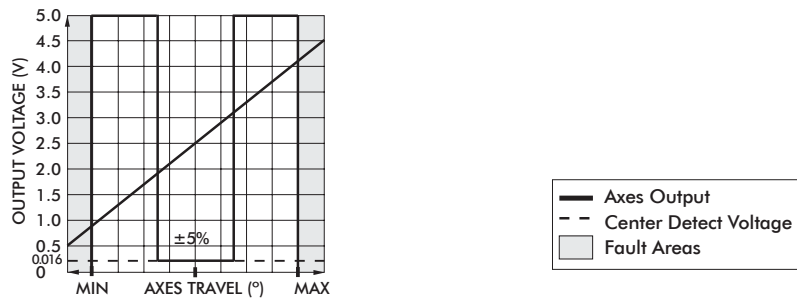

ELECTRICAL SPECIFICATIONS

Supply Power	-	4.5V to 5.5V
Supply Current	-	30mA + 10mA per axis

WIRING SPECIFICATION

Red Wire	-	Power supply 4.5 - 5.5VDC
Black Wire	-	Ground
Blue Wire	-	X axis output
Yellow Wire	-	Y axis output
Green Wire	-	Z axis output
Blue/White Wire	-	X axis center detect logic output
Yellow/Black Wire	-	Y axis center detect logic output
Green/Black Wire	-	Z axis center detect logic output
White Wire	-	Pushbutton common wire
Orange,violet,gray,brown,pink,bl/wt,y/bk,gn/bk,gy/w wire	-	Pushbutton outputs

HFX series I

First generation Hall effect joysticks

CONFIGURATION OPTIONS - continued

ADDITIONAL OUTPUT OPTIONS

VOLTAGE REGULATOR

The Voltage Regulator is a multi-wired analog option used to mate to a variety of industrial control voltages. The Voltage Regulator may be used when the supply or output voltage is greater than 5V or when bipolar output is required.

User Specified Supply Voltage:

- 5 VDC
- 10 VDC
- 12 VDC
- 24 – 30 VDC
- Custom supply options available.

User Specified Output Voltage:

- 0-5 VDC
- 0-10 VDC
- +/-5 VDC
- +/-10 VDC
- Custom outputs available.

ELECTRICAL SPECIFICATIONS

Supply Power	-	5VDC to 30VDC
Supply Current	-	90mA max

WIRING SPECIFICATION

Red wire	-	Supply power 5-30VDC
Black wire	-	Ground
Blue wire	-	X axis output
Yellow wire	-	Y axis output
Green wire	-	Z axis output
White wire	-	Pushbutton common wire
Orange,violet,gray,brown,pink,bl/wt/y/bk,gn/bk,gy/w wire	-	Pushbutton outputs

FRICITION CLUTCH

The Friction Clutch option provides absolute positioning. The joystick does not mechanically return to center, the handle maintains its position when released.

X-ON Electronics

Largest Supplier of Electrical and Electronic Components

Click to view similar products for [Input Devices](#) category:

Click to view products by [Apem](#) manufacturer:

Other Similar products are found below :

[80260-08](#) [M11L0A1](#) [M11L0B1M](#) [M21L0H1PX](#) [M41C091P100](#) [80260-00](#) [81521-08](#) [FKB4720-103](#) [84250-26](#) [84980-04](#) [84S-AC1-000](#)
[C10O0C1P](#) [JD-0700EU-2](#) [JM-0800-2](#) [JOY-THUMB](#) [JW-T0100](#) [89498-13](#) [89758-05](#) [89886-26](#) [89941-00](#) [FQ-XT](#) [G3-A1AM151NNNN](#)
[G80-3000LSCEU-2](#) [M11C011B](#) [TH500P00D4](#) [MJ0FGGRY](#) [JM-0800-0](#) [KBCV-4100W](#) [MR2110R5BB](#) [60C22-M7-4-020S](#) [67A-DF-3C-](#)
[060C](#) [84S-BB1-004](#) [81601-26](#) [G8011900LPMUS0](#) [G844420LUBEU0](#) [G84-4700LUCUS-0](#) [89701-26](#) [81485-26](#) [84105-13](#) [V400-W24 5M](#)
[V400-W23 5M](#) [G84-5200LCMEU-2](#) [M11F061P](#) [84Z2029-100](#) [4P182F1D0100](#) [M41L091M](#) [M41L091P](#) [60A00-8-050C](#) [84Z2029-78](#)
[XD2CF1111](#)