

# KR series

## Power rocker switches

*Distinctive features*

### Attractive rugged rocker switch

UG1410A-R2

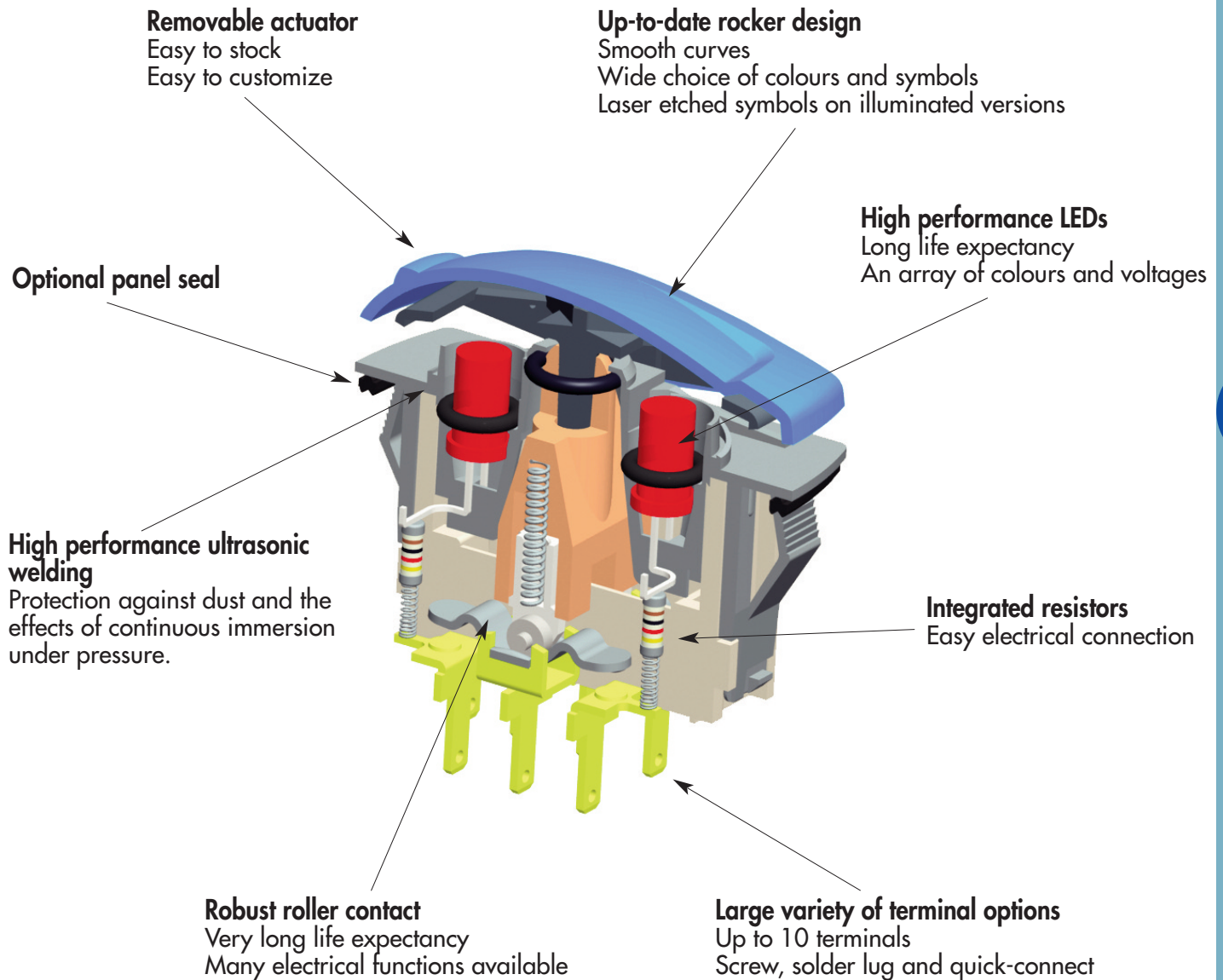

APEM will be happy to develop custom product solutions. Please contact us with your requirements.

The company reserves the right to change specifications without notice.

# KR series

## Power rocker switches

### Specifications



- Unique rocker design
- Wide choice of colours
- Laser etched symbols
- Illuminated or non-illuminated
- Optionally sealed to IP68 or IP69K

#### ELECTRICAL SPECIFICATIONS

- Current/voltage rating with resistive load :
  - Silver plated contacts :
    - A** : 5A 24VDC, 100.000 cycles - 10A 24VDC, 10.000 cycles (terminals 6.35 x 0.8 only)
    - S** : 20A 12VDC, 10.000 cycles (see Overview)
  - Gold plated contacts (D) : 20mA 12V, 150.000 cycles
- Current/voltage rating with lamp load - silver contacts (A) :
  - functions 1 & 6 : 100W 24VDC, 10.000 cycles
  - other functions : 60W 24VDC, 10.000 cycles
- Initial contact resistance : 10 mΩ max.
- Insulation resistance : 1.000 MΩ min. at 500VDC
- Dielectric strength : 2.000 Vrms 50 Hz min. between terminals
- Mechanical life : 150.000 cycles min.

#### MATERIALS

- Case : PA 6-6
- Actuator : ABS
- Bezel : PA 6-6
- Contacts & terminals : brass, solid silver grain, silver plated (**A or S**) or brass, solid silver grain, gold plated (**D**)
- Contact roller : brass, nickel plated

#### SEALING

Sealing is optional.  
To order a sealed product, complete the appropriate box of ordering format on the following pages.

#### ENVIRONMENTAL SPECIFICATIONS

- Sealing options :
  - K : IP68 to front panel components of switch only according to IEC 60529
  - Z : IP69K panel sealing according to DIN 40050-9
- Salt spray resistance : 96 hours according to IEC 512-6, test 11f
- Vibration resistance : 10-500 Hz / 10 g per IEC 60068-2-6
- Operating temperature : -40°C to +85°C

#### DIMENSIONS

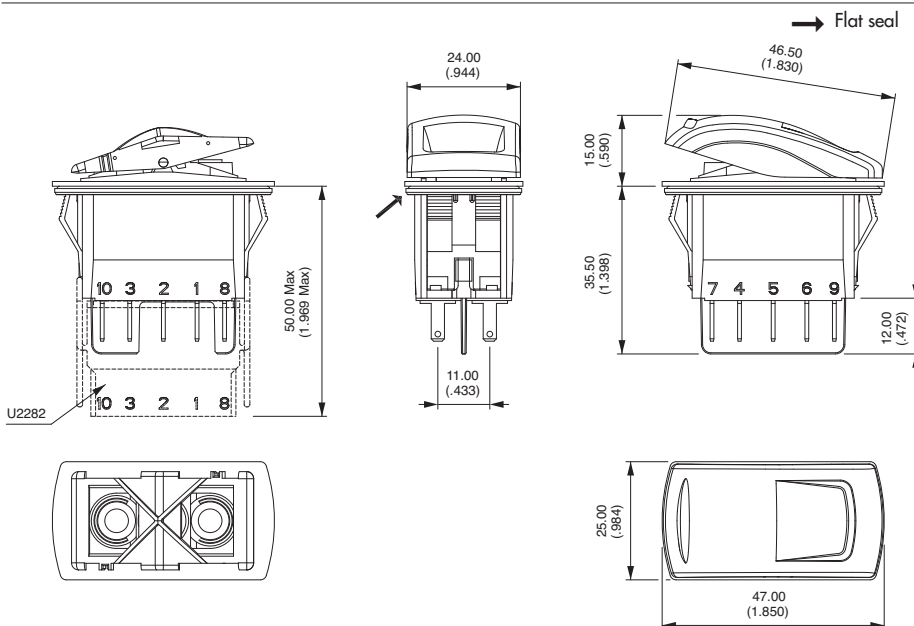

Packaging unit : 40 pieces

**Dimensions** : First dimensions are in mm while inches are shown as bracketed numbers.

# KR series

## Power rocker switches

Overview

### HOW TO ORDER

- To order a complete product, fill in all the boxes of the following order guide.
- To order case only (without actuator), finish your order number with the LED wiring code.
- To order actuator only (without case), begin the order number with code KRR, then follow the order format from "actuator type" until the end of the options.

### CASE + LEDS

KR						Side A	Side B	
<b>SERIES</b>	<b>Poles</b>		<b>Contacts</b>	<b>Sealing</b>	<b>LEDS</b>	<b>Wiring</b>		
	3 Single pole 4 Double pole		A Silver D Gold plated S Silver 20A *	X No K IP68 Z IP69K	X None A LED 6V red B LED 6V green C LED 6V yellow M LED 6V blue R LED 6V white D LED 12V red E LED 12V green F LED 12V yellow N LED 12V blue S LED 12V white J LED 24V red K LED 24V green L LED 24V yellow P LED 24V blue T LED 24V white ...	See following pages.		
	<b>Electrical functions</b>	<b>Terminals</b>	<b>Terminals (continued)</b>					
	1 ON - OFF 4 ON ON ON 4-1R ON ON MOM 5 MOM - ON 6 ON - ON 7 MOM OFF MOM 8 ON OFF MOM 9 ON OFF ON  Function 1 only for 6-terminal versions.	<b>Screw</b> 0 6 terminals with barrier <b>Solder lug/quick-connect</b> 2 6 terminals with barrier 4 6 terminals w/o barrier A 10 term. with barrier B 10 term. w/o barrier C 10 terminals for use with connector U2292 or U3152 <b>Normalized quick-connect 6,35x0,8</b> 3 6 terminals with barrier	5 6 terminals w/o barrier D 10 term. with barrier E 10 term. w/o barrier F 10 term. for use with connector U2292 or U3152 <b>Normalized quick-connect 2,8x0,8</b> G 10 term. with barrier H 10 term. w/o barrier J 10 terminals for use with connector U2282					

\* S contacts for all functions except 4 and 4-1R - for normalized quick-connect terminals 6,35x0,8 only.

### ACTUATOR

<b>Type</b>	<b>Colour</b>
1 For non-illuminated application 2 For illuminated application	1 Blue 1/4 Dark blue 2 Black 3 Green 4 Grey 5 Yellow 6 Red 7 Ivory 9 Orange A Aluminium bright

### ACTUATOR MARKING

	Area A	Area M	Area B
<b>Orientation</b>	<b>Symbols</b>		
N O S E			

Symbols & Accessories : see end of section D.



NOTICE : please note that not all combinations of above numbers are available. Refer to the following pages for further information.

# KR series

## Power rocker switches

Case

- To order case only (without rocker), finish your order number with the LED wiring code.

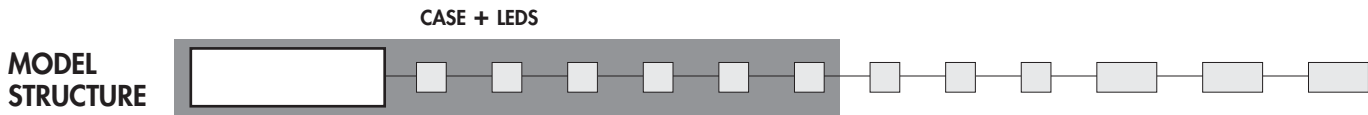

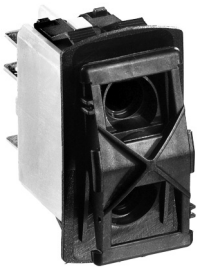

	Single pole	Double pole	2-3	1-2
KR31		KR41	ON	OFF
		KR44*	ON ON	ON
		KR44-1R*	ON ON	MOM
KR35		KR45	MOM	ON
KR36		KR46	ON	ON
KR37		KR47	MOM OFF	MOM
KR38		KR48	ON	OFF MOM
KR39		KR49	ON	OFF ON

\* Function 4 : single pole in double pole case

Bottom view

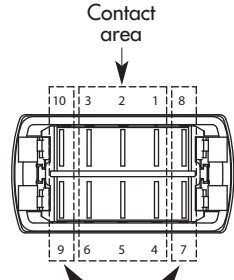

10 terminal version

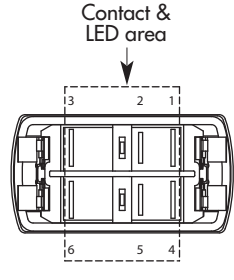

6 terminal version

LED area

D

### ELECTRICAL FUNCTIONS AND CONNECTIONS

In the tables below, terminal connections as viewed from bottom of switch.  
 Only the contact area is represented.  
 For single pole models, only terminals 1, 2 and 3 are to be considered (not terminals 6, 5, 4).

x = w/o terminal  
 o = with terminal  
 ▲ = momentary

	Positions		
Function 1 * KR31-KR41			
Function 5 KR35-KR45			
Function 6 KR36-KR46			
Function 7 KR37-KR47			
Function 8 KR38-KR48			
Function 9 KR39-KR49			
Function 4 KR44			
Function 4-1R KR44-1R			

\* Function 1 only available for 6 terminal versions.

# KR series

## Power rocker switches

Case

### TERMINALS

CASE + LEDS



Screw

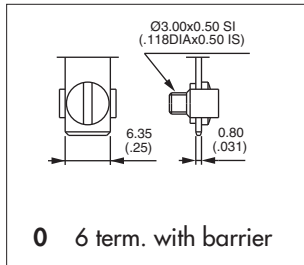

Solder lug / quick-connect

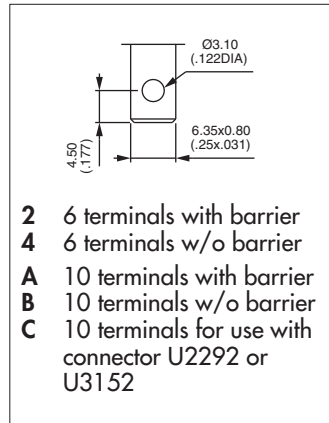

Normalized quick-connect 6,35x0,8

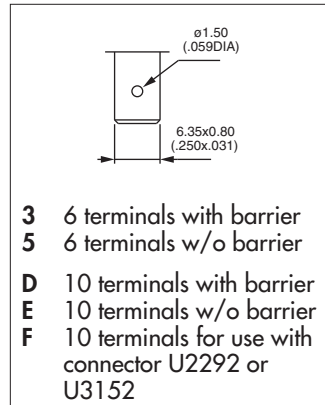

Normalized quick-connect 2,8x0,8

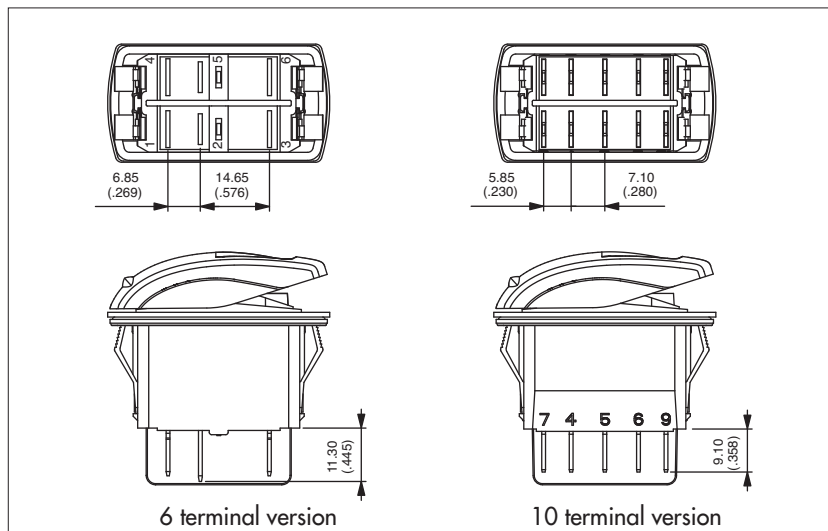
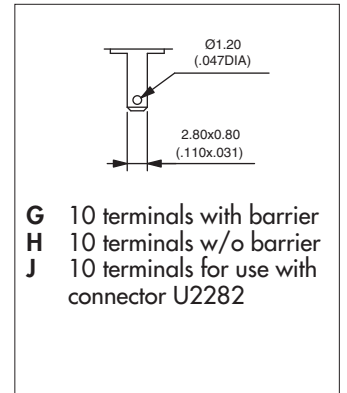

Terminals are marked on the case.

The drawings show the maximum possible number of terminals.

D

### CONTACT MATERIALS

CASE + LEDS



- A** Silver
- D** Silver, gold plated
- S** Silver 20A **NEW!**  
For all functions except 4 and 4-1R - for normalized quick-connect terminals 6,35x0,8 only.

# KR series

## Power rocker switches

Case - LEDs

### SEALING

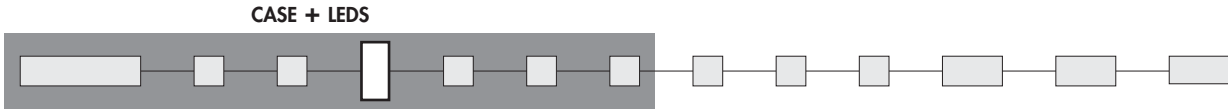

- X** No sealing
- K** IP68 (front panel components of switch only)
- Z** IP69K - Installation notice available on request

Ultrasonic welding of frame to case is standard on all versions.  
The ultrasonic welding and the optional panel seal prevent water and dust from introducing into the switch housing.

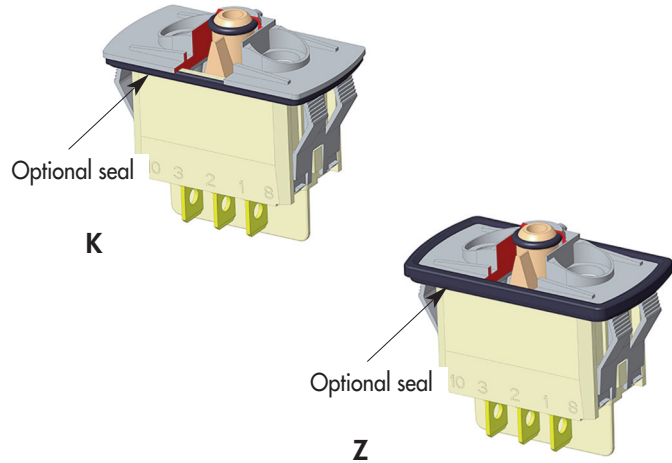

D

### LEDS

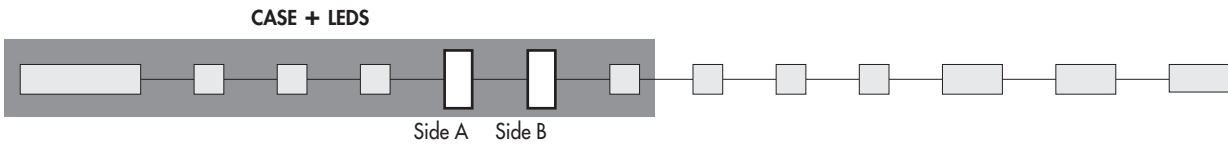

Complete each enlarged box with one of the codes listed below.

- X** Without LED

	Red	Green	Yellow	Blue	White	Amber	Red/green
6VDC	<b>A</b>	<b>B</b>	<b>C</b>	<b>M</b>	<b>R</b>	<b>4</b>	<b>1</b>
12VDC	<b>D</b>	<b>E</b>	<b>F</b>	<b>N</b>	<b>S</b>	<b>5</b>	<b>2</b>
24VDC	<b>J</b>	<b>K</b>	<b>L</b>	<b>P</b>	<b>T</b>	<b>6</b>	<b>3</b>
No resistor	<b>U</b>	<b>V</b>	<b>W</b>	<b>Y</b>	<b>Z</b>	<b>9</b>	<b>8</b>

LED consumption : 20mA @ nominal voltage (25°C)  
Other illumination solutions : on request.

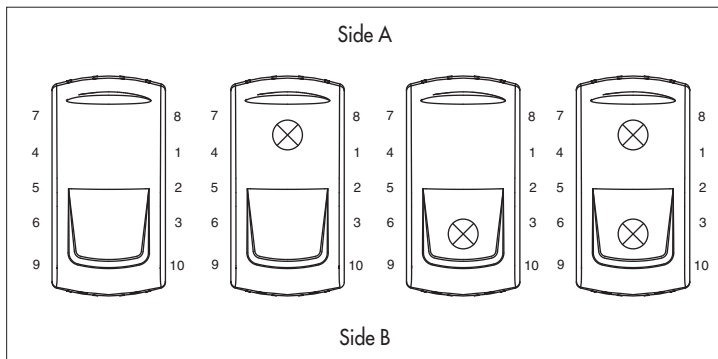

# KR series

## Power rocker switches

Case - LEDs

### WIRING

The LED wiring diagram is shown on the case.

CASE + LEDs

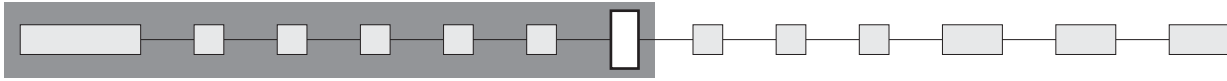

#### • For 6 terminal versions

LED connected to the load

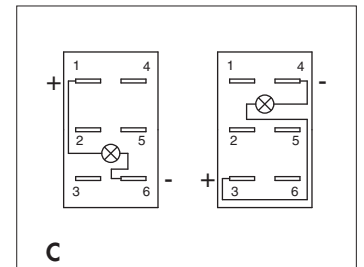
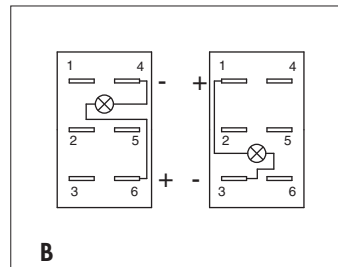
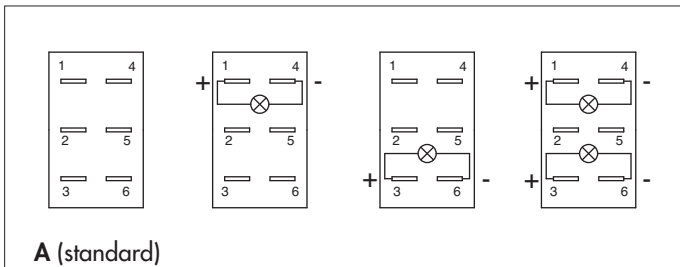

Note : If not available, terminals are added to connect the LED.

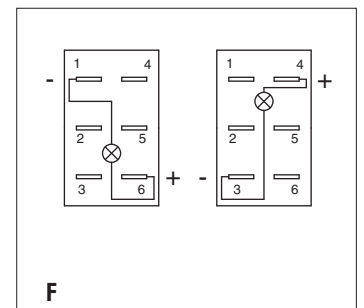
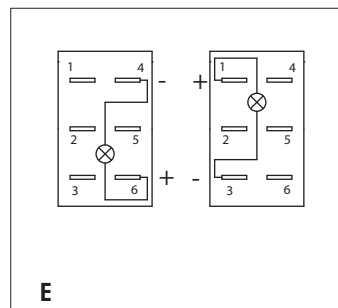
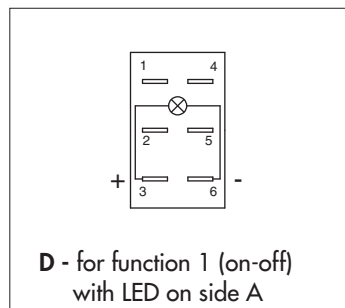

#### • For 10 terminal versions

Independent LED or integrated functions

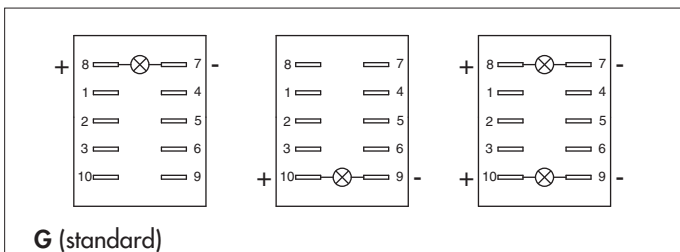

To have independent LEDs.

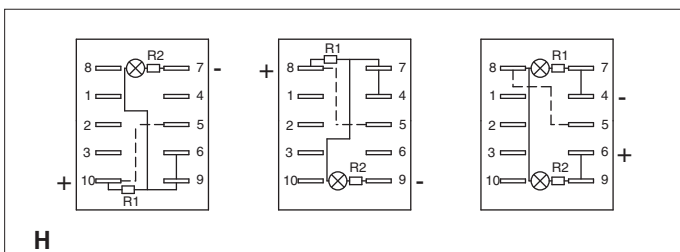

To obtain 2 symbol illumination levels (night illumination when OFF and higher illumination when ON).

H wiring with LED on side A available with functions 6, 8, 9 and 44.

H wiring with LED on side B available with functions 5, 6 and 9.

H wiring with 2 LEDs available with functions 8 and 9.

More information (H wiring schematics) : on request.

*Dotted line = external wiring, continuous line = internal wiring*

Available in Single Pole only, with H and J quick-connect terminals.

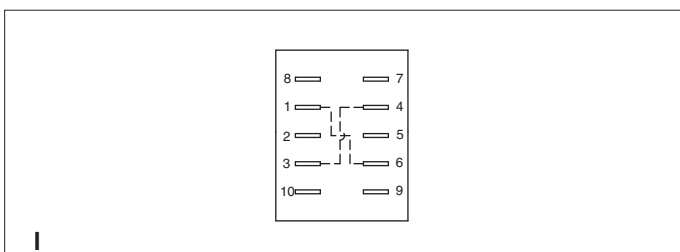

Power supply between 2 and 5 - Load between 1 and 4 or 3 and 6. Available with H and J quick-connect terminals.

To have a polarity inversion (typical application : fan motor).

*Dotted line = external wiring*

Please contact us for other wiring solutions.

# KR series

## Power rocker switches

### Actuator - Marking

To order actuator only (without case), begin the order number with code KRR, then follow the order format from "actuator type" until the end of the options.

#### ACTUATOR TYPE

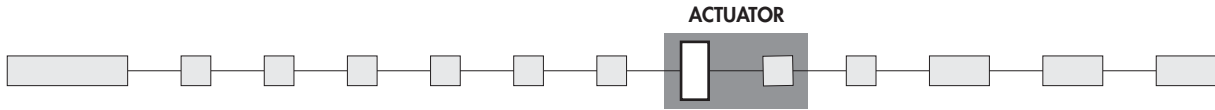

- 1 For non-illuminated application
- 2 For illuminated application

Other rocker design : on request.

#### ACTUATOR COLOUR

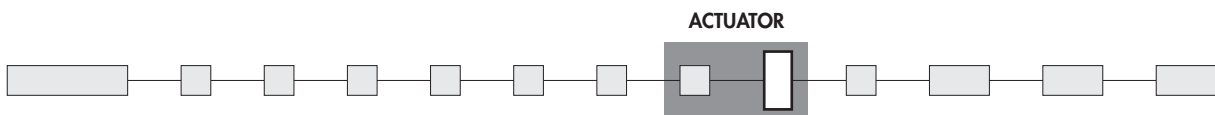

Code	Colour
1	Blue
1/4	Dark blue
2	Black
3	Green

Code	Colour
4	Grey
5	Yellow
6	Red
7	Ivory

Code	Colour
7/1	White
9	Orange
A	Aluminium bright

Note : colours 7 and 7/1 not available on illuminated versions.

A **soft-touch varnish** can be added. Consult us.



#### MARKING ORIENTATION

If no marking required, complete the box with code N.

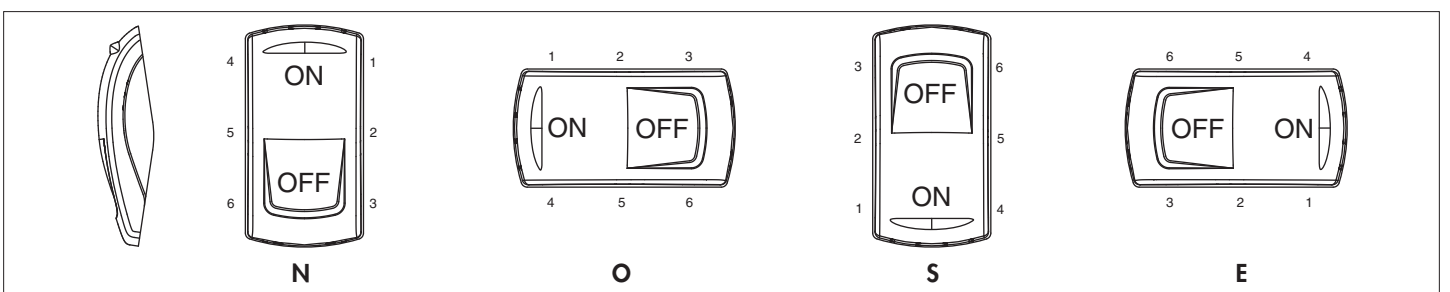
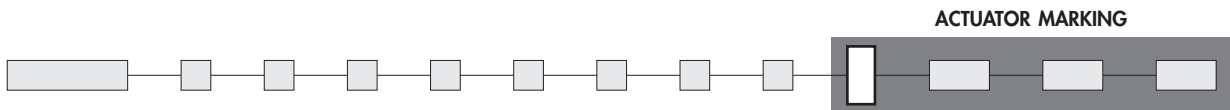

Other orientations : on request



# KR series

## Power rocker switches

Marking - Mounting

### SYMBOLS

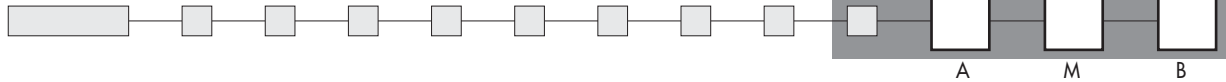

### ACTUATOR MARKING

A M B

**XX** No symbol

**Available symbols** : see end of section D.

### Marking colour

White marking for illuminated rockers (laser etching) and non-illuminated black rockers (pad printing). Black marking for non-illuminated colour rockers (pad printing). Other : on request.

### Laser etching resistance

- Water and petrol resistant according to EN61058-1
- Tear resistant (cross-cut test) according to NF ISO 2409 : class 0
- UV resistant according to ISO 4892-2

### Marking area

For illuminated versions. The symbol will be included in the hatched area. Marking in M area : on request.

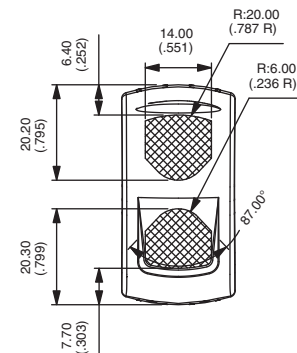
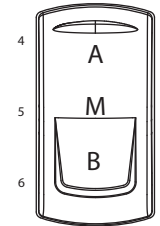

### MATRIX MOUNTING

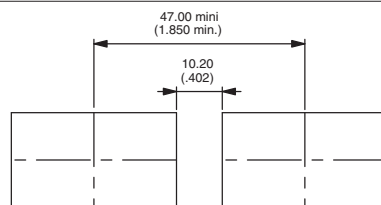
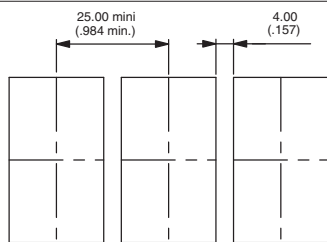

### PANEL CUT-OUT

Panel thickness : 0,8 mm to 4,6 mm  
Recommended panel thickness : between 2 mm and 3,5 mm

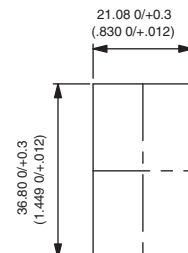

### SPECIFIC MATRIX MOUNTING FOR Z VERSION

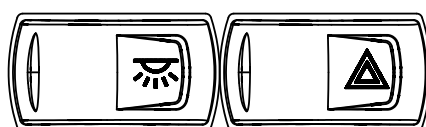
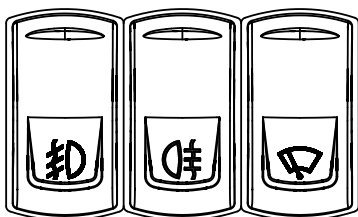
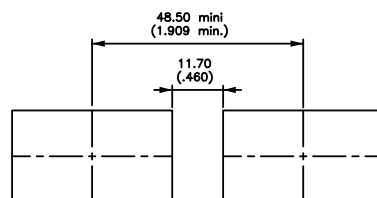
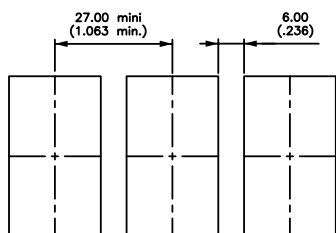

# K range

## Power rocker switches and indicators





### Symbols

















Most symbols meet the ISO 7000 standard "graphical symbols for use on equipments" (code given in bracket in the description). Contact us for symbols not featured in the following tables.















#### Legend scale :

KR series : 1:1

KL, KG and KI series : depending on space available on the product (see "Symbols" section at the end of each series).

CODE	SYMBOL	DESCRIPTION
XX	None	-
01	ON	-
02	OFF	-
03	○	-
04	I	-
05	II	-
06	STOP	-
07	A	Stop
08	M	Motion
09	▲	Up motion
10	▼	Down motion
11		Hot
12		Cold
13		Hazard warning (0085)
14		Traveller lighting
15		Driver lighting (1421)

CODE	SYMBOL	DESCRIPTION
16		Revolving light
17		Rear ventilator
18		Heating (0637)
19		Door opening
20		Windshield demister/defroster (0635)
21		Windshield wiper (0086)
22		Windshield washer (0088)
23		Ventilator fan (0089)
24		Side mirror defroster
25		Restarting pump
26		Front fog lights (0633)
27		Rear fog lights (0634)
28		Propulsion system trim
29		Beacon (1141)
30		Anchor
31		Electric motor (0011)

CODE	SYMBOL	DESCRIPTION
32		Emergency first aid vehicle (2565)
33		Load tipping (1557)
34		Loading light (2457)
35		Tractor, rear-ward (1667)
36		Combine, direction of movement (1678)
37		Use no forks (2406)
38		Transmission (1166)
39		Working spot light (1145)
40		Engine (0640)
41		Horn (0244)
42		Lock (1656)
43		Taxi sign light (2551)
44		Working light (1204)
45		Working light symmetric (1204)
46		-
47	ASM	-

# K range

## Power rocker switches and indicators









































Symbols

Most symbols meet the ISO 7000 standard “graphical symbols for use on equipments” (code given in bracket in the description). Contact us for symbols not featured in the following tables.

### Legend scale :

KR series : 1:1

KL, KG and KI series : depending on space available on the product (see “Symbols” section at the end of each series).

CODE	SYMBOL	DESCRIPTION	CODE	SYMBOL	DESCRIPTION	CODE	SYMBOL	DESCRIPTION
48		All wheel drive	64		Indicator	80		Front windshield heating
49		Differential lock (1662)	65		Brake release	81	AUS	Aus
50		-	66		Baggage room left door	82		Radiator fan
51		-	67		Baggage room right door	83		Remove retarder
52		-	68		Power blinds	84		Restricted speed
53	N	-	69		Engine idle control	85		Preheater
54		Rear window wiper (0097)	70	CRUISE RES/SET	Cruise res/set	86		ABS detection
55		Rear window washer (0099)	71		Driver windows up/down	87		ECAS detection
56		Lower load (2223)	72		Middle door opening	88		Engine stop
57		Cab lock (1560)	73		Front door opening	89	CRUISE RES/CAN	Cruise res/cancel
58		Extraction	74		Lighting in baggage room	90		ECAS reset
59		Pumping in	75	CRUISE ON/OFF	Cruise on/off	91		Driver windows heating
60		Rear PTO (1572)	76	TV	TV	92	CRUISE SET+/SET-	Cruise set
61		Front PTO	77		Pump	93		Air bag up/down
62		Rockshaft down	78	WC	Toilet	94		Read lighting
63		Rockshaft up	79		Toilet decontamination	95		Lighting main switch

# K range

## Power rocker switches and indicators

















### Symbols

















Most symbols meet the ISO 7000 standard “graphical symbols for use on equipments” (code given in bracket in the description). Contact us for symbols not featured in the following tables.





#### Legend scale :

KR series : 1:1

KL, KG and KI series : depending on space available on the product (see “Symbols” section at the end of each series).

CODE	SYMBOL	DESCRIPTION
96		Heating using water
97		Low beam
98		Position lights
99		Diesel acceleration
A1		Manual mode
A2		Clockwise cabin rotation
A3		Anticlockwise cabin rotation
A4		-
A5		-
A6		Parking brake
A7		-
A8		-
A9		-
AA		-
AB		-
AC		-

CODE	SYMBOL	DESCRIPTION
AD		-
AE		-
AF		-
AG		Battery charging condition (0247)
AH		Turn signals (0084)
AJ		High beam (0082)
AK		Differential lock, bogie (2600)
AL		Brushing with a rotating brush (0070)
AM		Differential lock, transfer case 4x4 (2475)
AN		Loader bucket, float (1441)
AP		Loader bucket (1437)
AQ		Rear window washer & wiper (0098)
AR		Header Header drive (1579)
AS		Excavator/backhoe boom side shift (2091)
AT		Chemical water treatment (1851)
AU		Grapple skidder, single funct <sup>o</sup> boom (1762)

CODE	SYMBOL	DESCRIPTION
AV		-
AW		-
AY		-
AZ		-
B1	HIGH	-
B2	LOW	-
B3		-

# K range

## Power rocker switches and indicators

Accessories for KR, KL and KI series

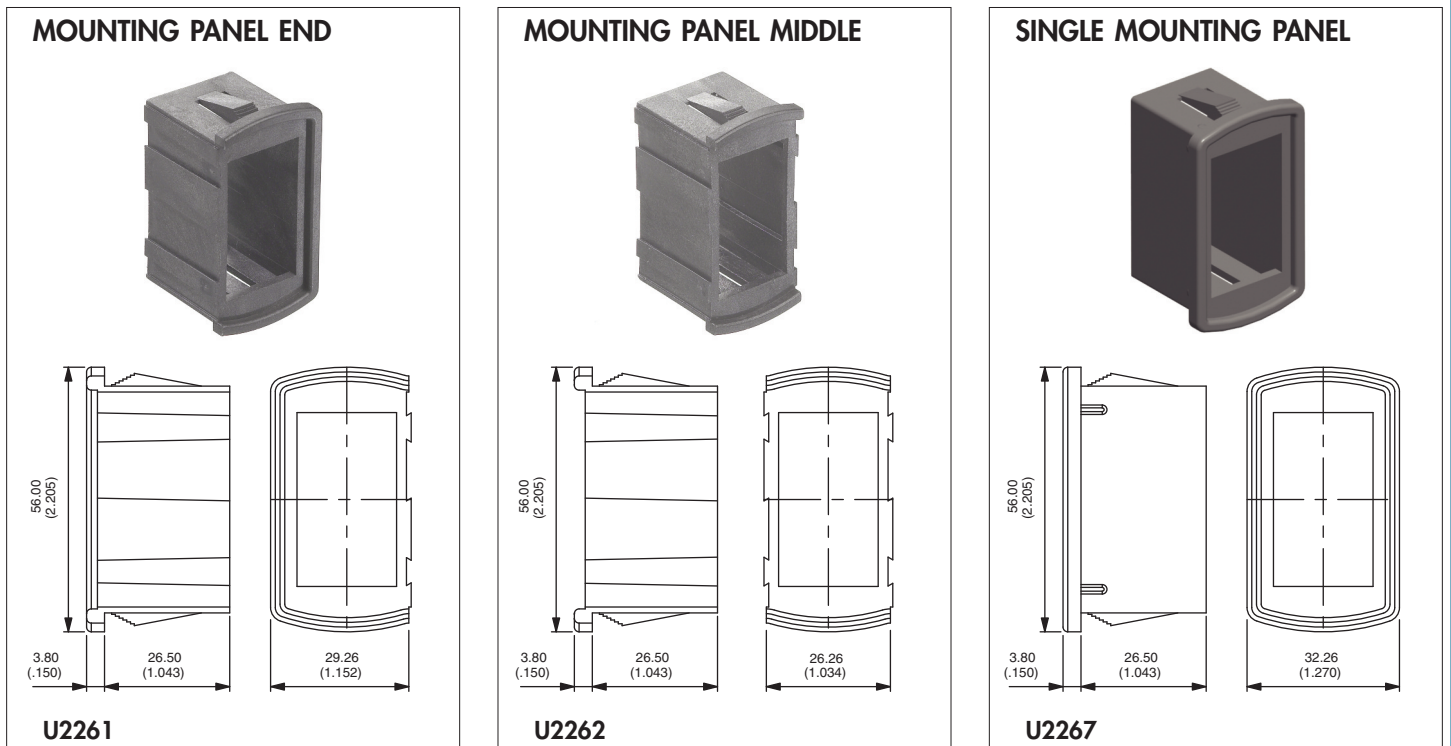

Recommended panel thickness : 1,10 mm - 1,80 mm - 2,60 mm - 3,40 mm - 4,20 mm - 5 mm - 5,80 mm

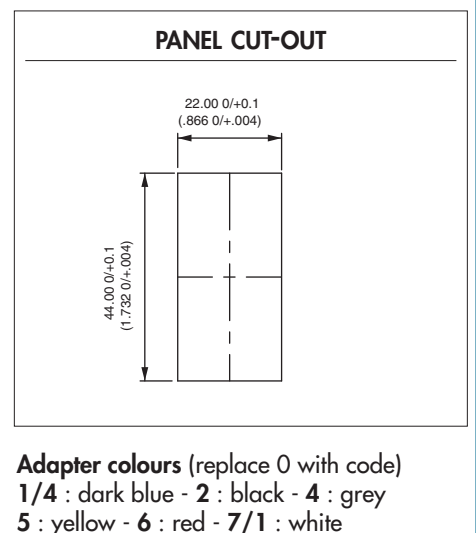
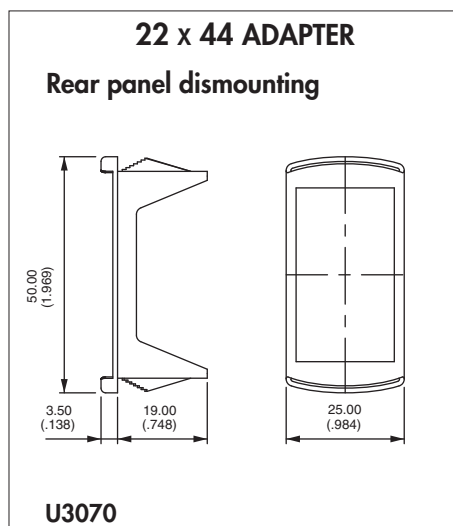
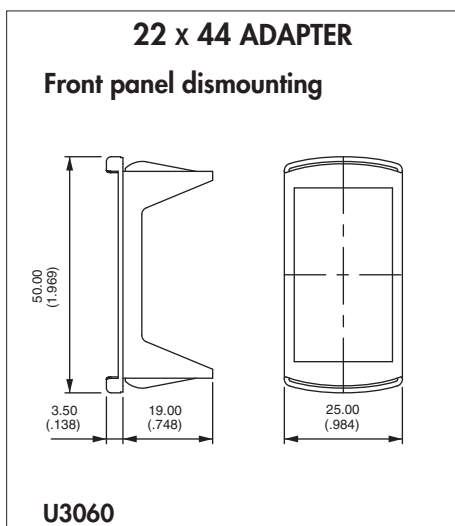
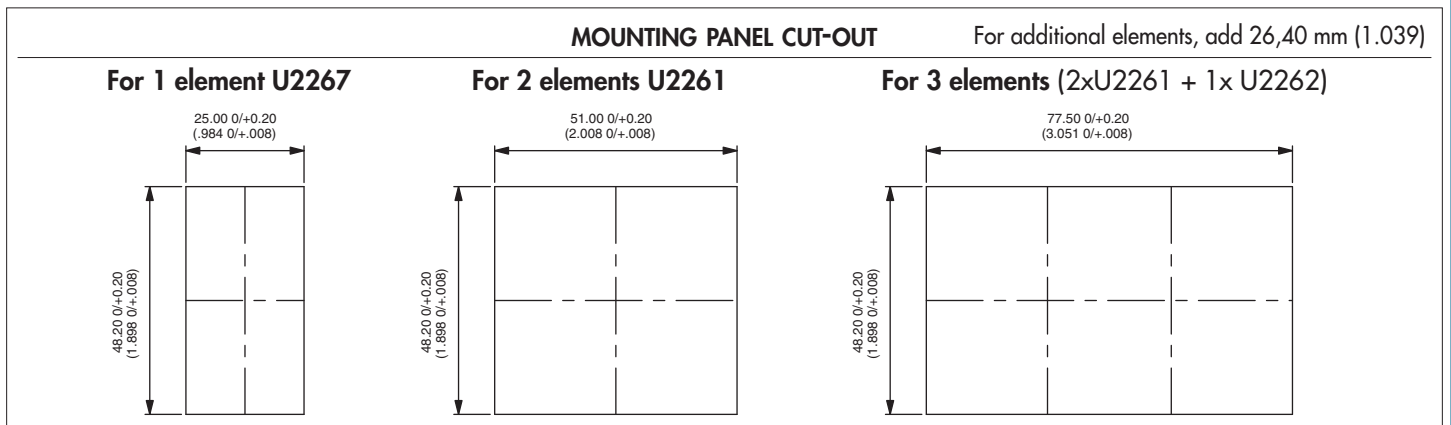

Recommended panel thickness : 0,60 mm to 1,50 mm

Recommended panel thickness : 1,60 mm -0,1/0 to 5,60 mm -0,1/0 in stages of 0,40 mm

# K range

## Power rocker switches and indicators

Accessories for KR, KL and KI series

### ACTUATOR REMOVING TOOL



**U3052**

2 tools are supplied

#### EXTRACT ACTUATOR (KR ONLY)

Allows the extraction of the rocker / rocker support assembly.  
Place the 2 claws under the support and push as indicated by the arrow.

#### EXTRACT ROCKER (KR ONLY)

Allows to separate the rocker from its support.  
Insert the tool between rocker and support as indicated by the arrow. Pull out the tool in the opposite direction.

#### EXTRACT SWITCH (KR, KL AND KI)

Allows to extract switch from panel mounting units. 2 tools are necessary.  
Insert the tools between switch and panel mounting units from the rear to compress the snap-in device. Pull off switch manually.

### CONNECTORS

Standard colour : black. Other colours : on request.  
Connectors cannot be combined with wiring types H and I.



**U2260**

#### 6 terminal version

For use with terminals type 2, 3, 4 or 5.  
6,35 (1/4) tabs to be fitted by the user  
(example : TE42282-2).  
Can be used for the KG series.

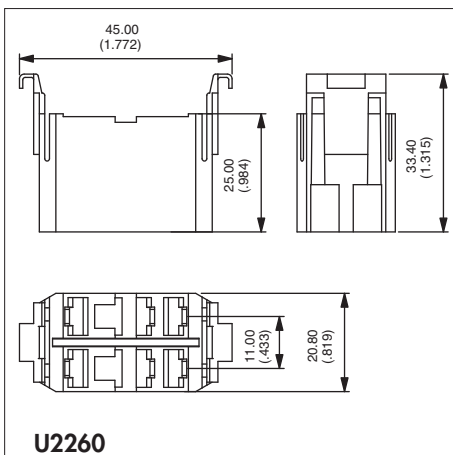

**U2260**

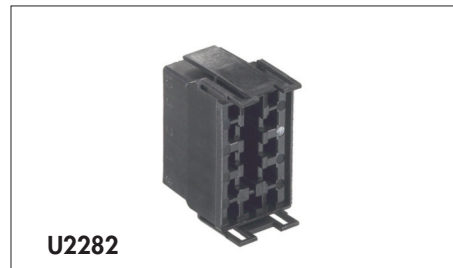

**U2282**

#### 10 terminal version

For use with terminals type H or J.  
2,8 (.110) tabs to be fitted by the user  
(example : AMP/Tyco 0-927779-3).

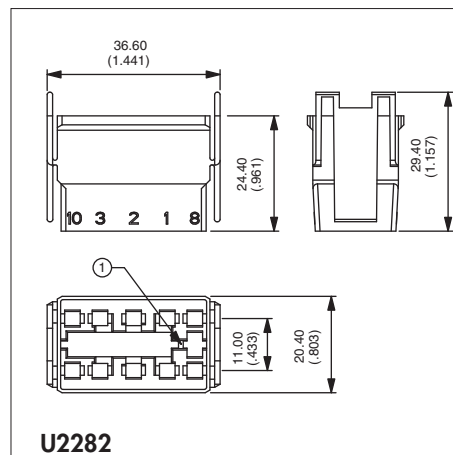

**U2282**



**U2292**

#### 10 terminal version

For use with terminals type B, C, E or F.  
6,35 (1/4) tabs to be fitted by the user  
(example : TE42282-2).

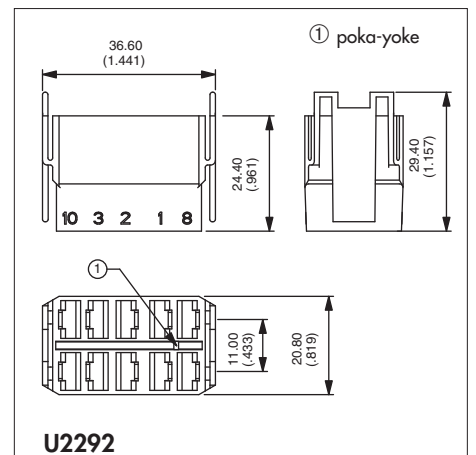

**U2292**

D

# K range

## Power rocker switches and indicators

Accessories for KR, KL and KI series

### CONNECTORS (continued)



U3152

**New!**

#### 10 terminal version

For use with terminals type B, C, E or F.  
6,35 (1/4) tabs to be fitted by the user  
(example : «Timer» terminals TE927833-2)

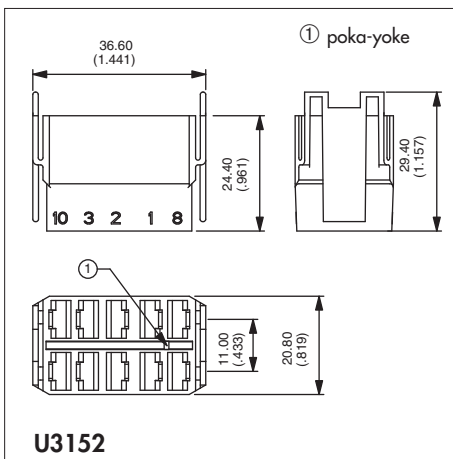

U3152

### BLANKING CAPS

Usefull for future extensions.

Code	Colour	Code	Colour
U2271	Blue	U2274	Grey
U2271/4	Dark blue	U2275	Yellow
U2272	Black	U2276	Red
U2273	Green	U2277	Ivory
		U2279	Orange

Recommended panel thickness :  
1,50 mm to 6 mm

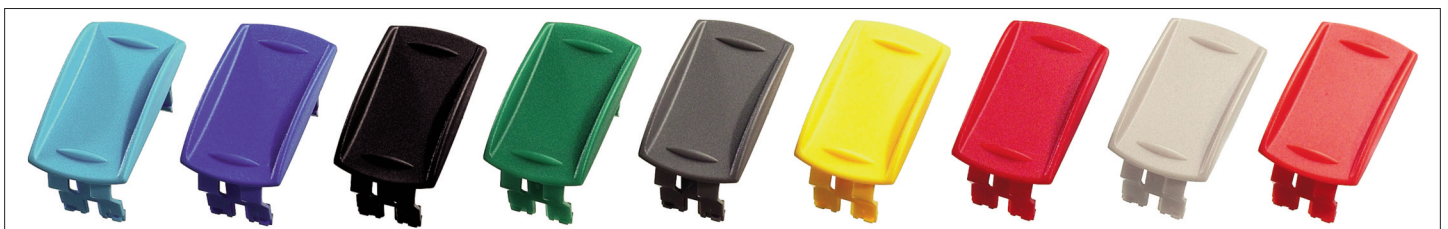
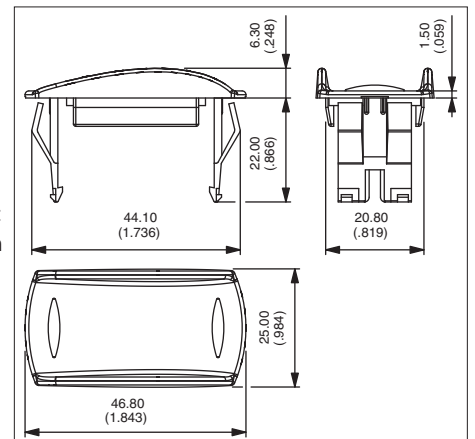

Connectors can be hanged on specific hole plugs. Contact APEM.

## X-ON Electronics

Largest Supplier of Electrical and Electronic Components

*Click to view similar products for [Rocker Switches](#) category:*

*Click to view products by [Apem](#) manufacturer:*

Other Similar products are found below :

[LTI LA6E-1S-WH-RC-FN12VXCR1](#) [6-1571986-9](#) [8007K26N324V52](#) [8055K32Z7V](#) [8055K52Z7V](#) [8138K20E6M50](#) [84206L](#) [84312LX](#)  
[PREDD5-07F-BB0GW](#) [999-16716-002](#) [999-16716-003](#) [999-16716-004](#) [A101J1V3Q004](#) [A101J2ZQ004](#) [A101J4ZQ004](#) [A101J51CB0004](#)  
[A103J1ZQ004](#) [A201J1AQ004](#) [A201J3ZB004](#) [A201J50ZQ004](#) [A203J51ZQ0004](#) [A435S1YZQ](#) [H8500XBBBBBL-A](#) [H8653VBBG2577W](#)  
[HB130CHNWWNAAC](#) [R13112ABB-602W](#) [1251.0303](#) [AE205J60V3B004](#) [1352.0107](#) [1500G51E](#) [1571099-3](#) [1571987-4](#) [1571987-5](#)  
[1571989-7](#) [1571988-5](#) [B123J77V7B2](#) [B226J50W4Q22P](#) [B433J37ZQ22M](#) [160212E](#) [1634200-7](#) [1801.1164](#) [1839.1502](#) [PANEL-PLUG-VHP-](#)  
[BLACK](#) [PANEL-PLUG-VHP-WT](#) [K1ABBSCADN](#) [K2ABAAAAAA](#) [KG312A2DXD246X](#) [250011E714](#) [2600HM11E](#) [2600R21E](#)