

Blattfeder Kontaktsystem

- Microschalter Bauform A gem. DIN 41635
- funktionale Endkontrolle
- solide Konstruktion
- hochwertige Materialien
- sehr genaue Schaltlage
- Sonderausführung mit 3,5N erfüllt Glühdrahtprüfung GWT750°C/2s nach DIN EN6335-1 (Hausgerätenorm)

Leaf spring mechanism

- Micro switches design A acc. to DIN 41635
- functional final inspection and testing
- solid design
- high-quality materials
- very exact switching position
- special version 3.5N fulfils glow wire testing GWT750°C/2s acc. DIN EN6335-1 (household appliance standard)

Microschalter, auch als Schnappschalter bezeichnet, werden vorrangig als Endschalter eingesetzt, sind aber auch für viele weitere Industrieanwendungen geeignet. Die Schaltgeschwindigkeit ist weitgehend unabhängig von der eigentlichen Betätigungsgeschwindigkeit. Die nach ISO 9001:2000 zertifizierte Fertigung und die 100% funktionale Endkontrolle garantieren die zuverlässige Funktion. Bei diesen Schaltern haben wir unsere langjährige Erfahrung und Zuverlässigkeit im Schalterbau eingebracht.

Micro switches, also known as snap action switches, are primarily used as limit switches, but are also suitable for many other industry applications. The actual switching speed is completely independent from the speed of operation. ISO 9001:2000 approved production together with 100% functional final inspection and testing guarantee reliable operation. These products reflect our long standing experience in design and production of high quality switches.

MECHANISCHE KENNWERTE	MECHANICAL DATA	
Mech. Lebensdauer	Mech. lifetime	2 000 000 Schaltungen / 2 000 000 actuations
Sonderausführung 3,5N	Special version 3.5N	10 000 000 Schaltungen / 10 000 000 actuations
Elektr. Lebensdauer	Electrical lifetime	min. 50 000 Schaltungen / min. 50 000 actuations
abhängig von Schaltleistung	depending on switching capacity	
Differenzweg	Movement differential	≤ 0,4mm
Vorlaufweg	Pretravel	≤ 1,4mm
Nachlaufweg	Overtravel	0,75 - 1,5mm
Schaltpunkt	Operating position	14,8 ± 0,6mm
Kontaktöffnungsweite	Contact opening	<3mm (μ)
SONSTIGE KENNWERTE	OTHER DATA	
Zulassungen	Approvals	ENEC-VDE, cULus
MATERIAL	MATERIAL	
Gehäuse	Housing	PBT/PET (UL94-V0)
Deckel	Cover	PBT/PET (UL94-V0)
Betätiger	Actuator	Phenolic (UL94-V0)
Anschlüsse	Terminals	CuZn versilbert / CuZn Ag plated
Kontakte	Contacts	AgNi
Kontaktgeber	Contact spring	CuBe

MAB1 Plunger

2 SCHALTLEISTUNG / RATING

	cULus		Code: MAB1 01	3	4	5	6	7	8	9
1(0,3)A 250VAC	1A 125VAC	☎								
5(2)A 250VAC	5A 125VAC	☎								
10(3)A 250VAC	10A 125VAC	☎								
16(4)A 250VAC	16A 125VAC	☎								

3 BETÄTIGUNGSKRAFT / OPERATING FORCE

		Code: MAB1 2	A	4	5	6	7	8	9
0,8N	☎								
1,0N	☎		B	4	5	6	7	8	9
1,5N	☎		C	4	5	6	7	8	9
2,0N	☎		D	4	5	6	7	8	9
2,5N	☎		E	4	5	6	7	8	9
3,0N	☎		F	4	5	6	7	8	9
3,5N	☎		G	4	5	6	7	8	9
4,0N	☎		H	4	5	6	7	8	9

EMPFOHLENE KOMBINATIONEN / RECOMMENDED COMBINATIONS

	0,8N	1,0N	1,5N	2,0N	2,5N	3,0N	3,5N	4,0N
1(0,3)A 250VAC	■	■	■	■	■	■		■
5(2)A 250VAC	■	■	■	■	■	■		■
10(3)A 250VAC		■	■	■	■	■		■
16(4)A 250VAC			■	■	■	■	■	■

4 UMGEBUNGSTEMPERATUR / AMBIENT TEMPERATURE

-10...+105°C		Code: MAB1 2 3	01	5	6	7	8	9
-10...+125°C	☎	Code: MAB1 2 3	02	5	6	7	8	9

5 KONTAKTANORDNUNG / CONTACT ARRANGEMENT

Öffner / Normally closed	Schließer / Normally open	Wechsler / Change-over
☎ Code: MAB1 2 3 4 A 6 7 8 9	Code: MAB1 2 3 4 B 6 7 8 9	Code: MAB1 2 3 4 C 6 7 8 9

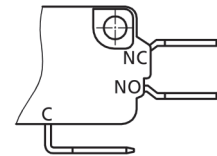
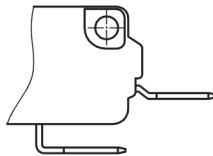
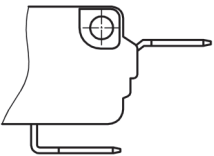

6 BETÄTIGER / ACTUATOR

Stößel / Plunger
Code: MAB1 2 3 4 5 01 7 8 9

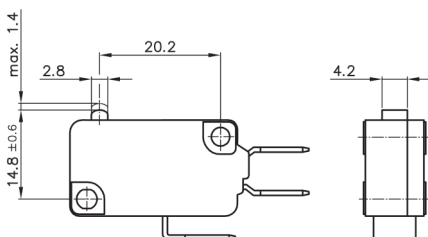

7 EINHÄNGEPUNKT / FIXING POSITION

Kein Zusatzbetätiger / No additional actuator
Code: MAB1 2 3 4 5 6 X 8 9

☎ = auf Anfrage / upon request

MAB1 Stöbel

8

ANSCHLÜSSE / TERMINALS

Steckanschluss 0,8x6,3mm / Plug connection

Code: MAB1 2 3 4 5 6 7 01 9

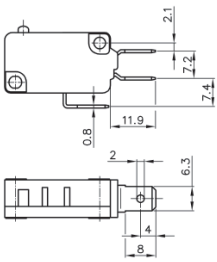

Steckanschluss 0,5x4,7mm / Plug connection

Code: MAB1 2 3 4 5 6 7 02 9

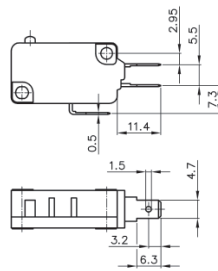

Steckanschluss 0,8x4,7mm / Plug connection

Code: MAB1 2 3 4 5 6 7 03 9

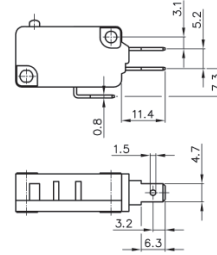

Steck/Lötanschluss 0,5x4,7mm

Plug/solder terminal

Code: MAB1 2 3 4 5 6 7 04 9

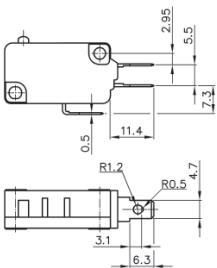

LP-Anschluss links / PCB terminal left

Code: MAB1 2 3 4 5 6 7 05 9

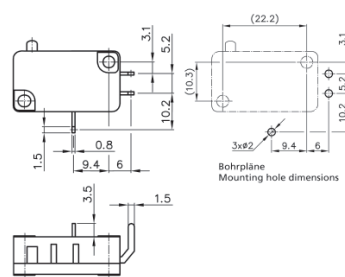

LP-Anschluss rechts / PCB terminal right

Code: MAB1 2 3 4 5 6 7 06 9

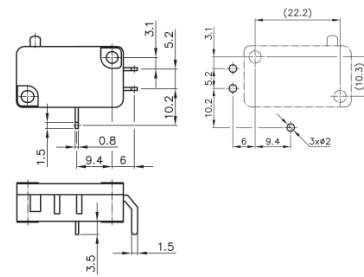

Lötöse / Solder terminal

Code: MAB1 2 3 4 5 6 7 07 9

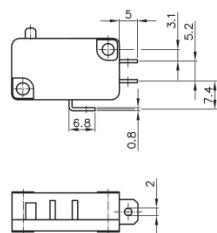

Schraubanschluss / Screw terminal

Code: MAB1 2 3 4 5 6 7 08 9

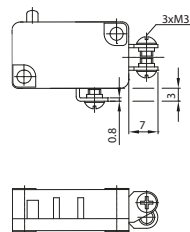

Rast 5 / Pin spacing 5

Code: MAB1 2 3 4 5 6 7 09 9

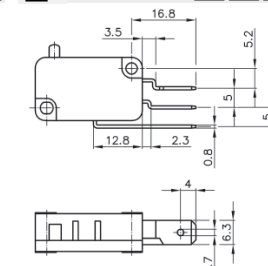

9

KONTAKTÖFFNUNG / CONTACT GAP

<3mm (Standard)

Code: MAB1 2 3 4 5 6 7 8 A

= auf Anfrage / upon request

= auf Anfrage / on request

Weitere Informationen finden Sie im Internet: www.hartmann-codier.de

Technische Änderungen vorbehalten / Specifications are subject to change without notice.

MAB1 Plunger

ÜBERSICHT BETÄTIGER / WEGE / KRÄFTE
OVERVIEW ACTUATORS / TRAVEL / FORCES

	Code	mm	≤ N	Code	≤ N	≤ mm	min. mm	≤ mm	≤ mm	mm
		Zusatzbetätigerlänge Actuator length	Betätigungskraft am Stößel Operating force on plunger		Betätigungskraft am Zusatzbetätiger Operating force on lever	Vorlaufweg Pretravel	Nachlaufweg Overtravel	Differenzweg Movement differential	Ruhestellung Free position	Schaltpunkt Operating position
Stößel	01	-	0,8	A	-	1,4	0,75 - 1,5	0,4	16,8	14,8 ±0,6
Plunger			1,0	B						
			1,5	C						
			2,0	D						
			2,5	E						
			3,0	F						
			3,5	G						
			4,0	H						

Von der Idee bis zur Produktion
From the idea to production

Drehcodierschalter
Rotary Code Switches

DIP-Schalter
DIP-Switches

Schiebeschalter
Slide Switches

Schalter und Buchsen
Switches and Jacks

Anzeigelemente
LED-Elements

Microschalter
Micro Switches

Zweistastcodierschalter
Dual Pushbutton Switches

Anhang
Appendix

1 MAB1 Hebel

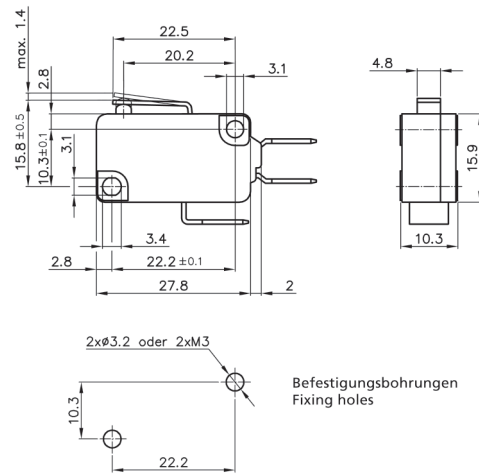
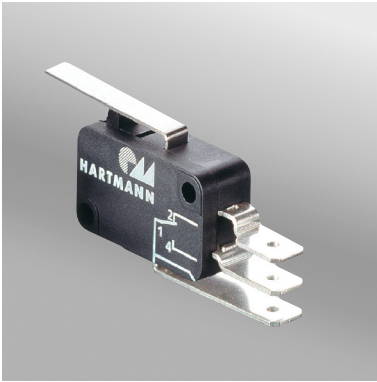

Blattfeder Kontaktsystem

- Microschalter Bauform A gem. DIN 41635
- funktionale Endkontrolle
- solide Konstruktion
- hochwertige Materialien
- sehr genaue Schaltlage
- Sonderausführung mit 3,5N erfüllt Glühdrahtprüfung GWT750°C/2s nach DIN EN6335-1 (Hausgerätenorm)

Leaf spring mechanism

- Micro switches design A acc. to DIN 41635
- functional final inspection and testing
- solid design
- high-quality materials
- very exact switching position
- special version 3.5N fulfils glow wire testing GWT750°C/2s acc. DIN EN6335-1 (household appliance standard)

Microschalter, auch als Schnappschalter bezeichnet, werden vorrangig als Endschalter eingesetzt, sind aber auch für viele weitere Industrieanwendungen geeignet. Die Schaltgeschwindigkeit ist weitgehend unabhängig von der eigentlichen Betätigungsgeschwindigkeit. Die nach ISO 9001:2000 zertifizierte Fertigung und die 100% funktionale Endkontrolle garantieren die zuverlässige Funktion. Bei diesen Schaltern haben wir unsere langjährige Erfahrung und Zuverlässigkeit im Schalterbau eingebracht.

Micro switches, also known as snap action switches, are primarily used as limit switches, but are also suitable for many other industry applications. The actual switching speed is completely independent from the speed of operation. ISO 9001:2000 approved production together with 100% functional final inspection and testing guarantee reliable operation. These products reflect our long standing experience in design and production of high quality switches.

MECHANISCHE KENNWERTE	MECHANICAL DATA	
Mech. Lebensdauer	Mech. lifetime	2 000 000 Schaltungen / 2 000 000 actuations
Sonderausführung 3,5N	Special version 3.5N	10 000 000 Schaltungen / 10 000 000 actuations
Elektr. Lebensdauer	Electrical lifetime	min. 50 000 Schaltungen / min. 50 000 actuations
abhängig von Schaltleistung	depending on switching capacity	
Differenzweg	Movement differential	siehe Übersicht nächste Seite / please see overview next page
Vorlaufweg	Pretravel	siehe Übersicht nächste Seite / please see overview next page
Nachlaufweg	Overtravel	siehe Übersicht nächste Seite / please see overview next page
Schaltpunkt	Operating position	siehe Übersicht nächste Seite / please see overview next page
Kontaktöffnungsweite	Contact opening	<3mm (µ)
SONSTIGE KENNWERTE	OTHER DATA	
Zulassungen	Approvals	ENEC-VDE, cULus
MATERIAL	MATERIAL	
Gehäuse	Housing	PBT/PET (UL94-V0)
Deckel	Cover	PBT/PET (UL94-V0)
Betätiger	Actuator	Phenolic (UL94-V0)
Anschlüsse	Terminals	CuZn versilbert / CuZn Ag plated
Kontakte	Contacts	AgNi
Kontaktgeber	Contact spring	CuBe

MAB1 Hinge lever

2 SCHALTLEISTUNG / RATING

	cULus		3	4	5	6	7	8	9
1(0,3)A 250VAC	1A 125VAC		Code: MAB1 01						
5(2)A 250VAC	5A 125VAC		Code: MAB1 02						
10(3)A 250VAC	10A 125VAC		Code: MAB1 03						
16(4)A 250VAC	16A 125VAC		Code: MAB1 04						

3 BETÄTIGUNGSKRAFT / OPERATING FORCE

			2	A	4	5	6	7	8	9
0,8N		Code: MAB1	2	A	4	5	6	7	8	9
1,0N		Code: MAB1	2	B	4	5	6	7	8	9
1,5N		Code: MAB1	2	C	4	5	6	7	8	9
2,0N		Code: MAB1	2	D	4	5	6	7	8	9
2,5N		Code: MAB1	2	E	4	5	6	7	8	9
3,0N		Code: MAB1	2	F	4	5	6	7	8	9
3,5N		Code: MAB1	2	G	4	5	6	7	8	9
4,0N		Code: MAB1	2	H	4	5	6	7	8	9

EMPFOHLENE KOMBINATIONEN / RECOMMENDED COMBINATIONS

	0,8N	1,0N	1,5N	2,0N	2,5N	3,0N	3,5N	4,0N
1(0,3)A 250VAC	■	■	■	■	■	■		■
5(2)A 250VAC	■	■	■	■	■	■		■
10(3)A 250VAC		■	■	■	■	■		■
16(4)A 250VAC			■	■	■	■	■	■

4 UMGEBUNGSTEMPERATUR / AMBIENT TEMPERATURE

-10...+105°C		Code: MAB1	2	3	01	5	6	7	8	9
-10...+125°C		Code: MAB1	2	3	02	5	6	7	8	9

5 KONTAKTANORDNUNG / CONTACT ARRANGEMENT

Öffner / Normally closed	Code: MAB1	2	3	4	A	6	7	8	9
Schließer / Normally open	Code: MAB1	2	3	4	B	6	7	8	9
Wechsler / Change-over	Code: MAB1	2	3	4	C	6	7	8	9

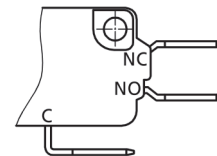
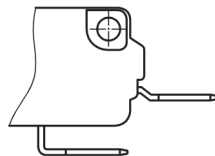
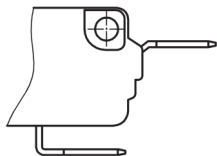

6 BETÄTIGER / ACTUATOR

Hebel kurz / Hinge lever short	Code: MAB1	2	3	4	5	03	7	8	9
Hebel mittel / Hinge lever medium size	Code: MAB1	2	3	4	5	04	7	8	9
Hebel lang / Hinge lever long	Code: MAB1	2	3	4	5	05	7	8	9

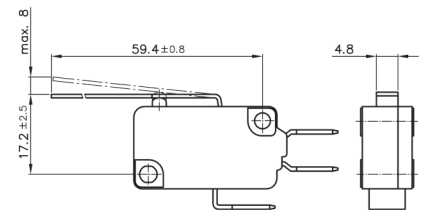
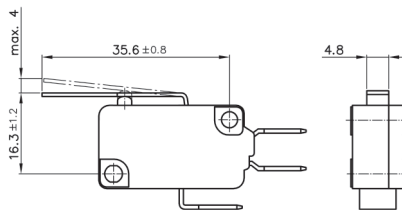
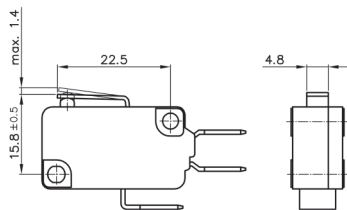

7 EINHÄNGEPUNKT / FIXING POSITION

vorne / front	Code: MAB1	2	3	4	5	6	A	8	9
hinten / rear	Code: MAB1	2	3	4	5	6	B	8	9

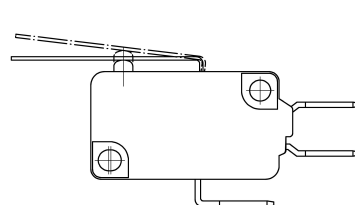
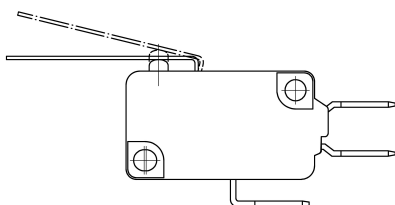

= auf Anfrage / upon request

MAB1 Hebel

8 ANSCHLÜSSE / TERMINALS

Steckanschluss 0,8x6,3mm / Plug connection

Code: MAB1 2 3 4 5 6 7 01 9

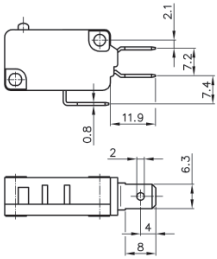

Steckanschluss 0,5x4,7mm / Plug connection

Code: MAB1 2 3 4 5 6 7 02 9

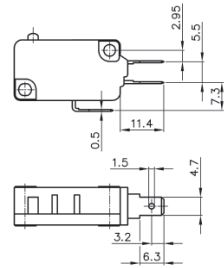

Steckanschluss 0,8x4,7mm / Plug connection

Code: MAB1 2 3 4 5 6 7 03 9

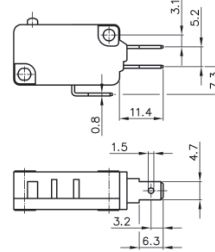

Steck/Lötanschluss 0,5x4,7mm / Plug/solder terminal

Code: MAB1 2 3 4 5 6 7 04 9

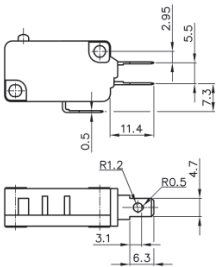

LP-Anschluss links / PCB terminal left

Code: MAB1 2 3 4 5 6 7 05 9

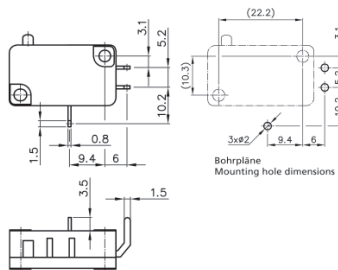

LP-Anschluss rechts / PCB terminal right

Code: MAB1 2 3 4 5 6 7 06 9

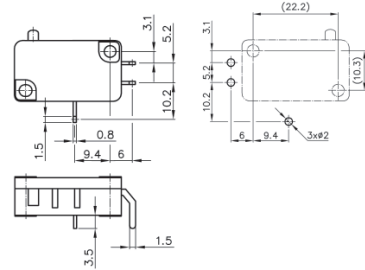

Lötöse / Solder terminal

Code: MAB1 2 3 4 5 6 7 07 9

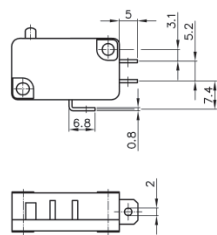

Schraubanschluss / Screw terminal

Code: MAB1 2 3 4 5 6 7 08 9

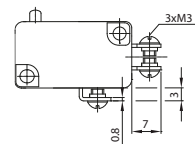

Rast 5 / Pin spacing 5

Code: MAB1 2 3 4 5 6 7 09 9

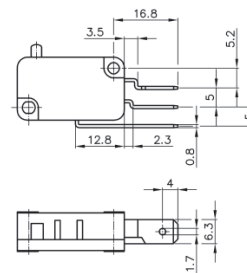

9 KONTAKTÖFFNUNG / CONTACT GAP

<3mm (Standard)

Code: MAB1 2 3 4 5 6 7 8 A

= auf Anfrage / upon request

= auf Anfrage / on request

Weitere Informationen finden Sie im Internet: www.hartmann-codier.de

Technische Änderungen vorbehalten / Specifications are subject to change without notice.

MAB1 Hinge lever

ÜBERSICHT BETÄTIGER / WEGE / KRÄFTE
OVERVIEW ACTUATORS / TRAVEL / FORCES

Einhängepunkt vorne / Fixing position front	Code	mm	Zusatzbetätigerlänge Actuator length		Betätigungskraft am Stößel Operating force on plunger		Betätigungskraft am Zusatzbetätiger Operating force on lever		Vorlaufweg Pretravel	Nachlaufweg Overtravel	Differenzweg Movement differential	Ruhstellung Free position	Schaltpunkt Operating position
			≤ N	Code	≤ N	≤ mm	min. mm	≤ mm					
Hebel kurz Hinge lever short	03	28,2	0,8	A	0,65	3,2	1,5	0,8	19,7	16,4±1			
			1,0	B	0,79								
			1,5	C	1,20								
			2,0	D	1,60								
			2,5	E	2,00								
			3,0	F	2,40								
			3,5	G	2,80								
			4,0	H	3,20								
Hebel mittel Hinge lever medium size	04	41,2	0,8	A	0,45	6,2	3,0	1,2	26	17,8±1,5			
			1,0	B	0,54								
			1,5	C	0,85								
			2,0	D	1,10								
			2,5	E	1,38								
			3,0	F	1,70								
			3,5	G	1,95								
			4,0	H	2,20								
Hebel lang Hinge lever long	05	64,9	0,8	A	0,28	11,7	4,5	2,0	34,7	20,5±2,5			
			1,0	B	0,35								
			1,5	C	0,52								
			2,0	D	0,70								
			2,5	E	0,87								
			3,0	F	1,05								
			3,5	G	1,22								
			4,0	H	1,40								
Einhängepunkt hinten / Fixing position rear	Code	mm	≤ N	Code	≤ N	≤ mm	min. mm	≤ mm	≤ mm	mm			
Hebel kurz Hinge lever short	03	22,5	0,8	A	0,80	1,4	1,0	0,5	17,7	15,8 ±0,5			
			1,0	B	1,00								
			1,5	C	1,50								
			2,0	D	2,00								
			2,5	E	2,50								
			3,0	F	3,00								
			3,5	G	3,50								
			4,0	H	4,00								
Hebel mittel Hinge lever medium size	04	35,6	0,8	A	0,36	4,0	2,0	1,0	21,5	16,3 ±1,2			
			1,0	B	0,45								
			1,5	C	0,70								
			2,0	D	0,90								
			2,5	E	1,15								
			3,0	F	1,30								
			3,5	G	1,60								
			4,0	H	1,80								
Hebel lang Hinge lever long	05	59,4	0,8	A	0,20	8,0	4,0	2,0	27,7	17,2 ±2,5			
			1,0	B	0,25								
			1,5	C	0,37								
			2,0	D	0,50								
			2,5	E	0,62								
			3,0	F	0,75								
			3,5	G	0,88								
			4,0	H	1,00								

Von der Idee bis zur Produktion
From the idea to production

Drehcodierschalter
Rotary Code Switches

DIP-Schalter
DIP-Switches

Schiebeschalter
Slide Switches

Schalter und Buchsen
Switches and jacks

Anzeigeelemente
LED-Elements

Microschalter
Micro Switches

Zweistastcodierschalter
Dual Pushbutton Switches

Anhang
Appendix

1 MAB1 Rolle

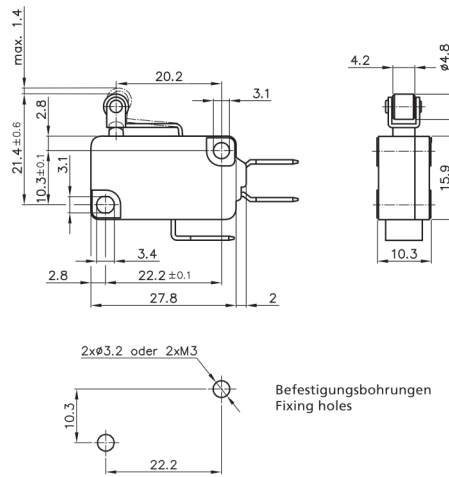

Blattfeder Kontaktsystem

- Microschalter Bauform A gem. DIN 41635
- funktionale Endkontrolle
- solide Konstruktion
- hochwertige Materialien
- sehr genaue Schaltlage
- Sonderausführung mit 3,5N erfüllt Glühdrahtprüfung GWT750°C/2s nach DIN EN6335-1 (Hausgerätenorm)

Leaf spring mechanism

- Micro switches design A acc. to DIN 41635
- functional final inspection and testing
- solid design
- high-quality materials
- very exact switching position
- special version 3.5N fulfils glow wire testing GWT750°C/2s acc. DIN EN6335-1 (household appliance standard)

Microschalter, auch als Schnappschalter bezeichnet, werden vorrangig als Endschalter eingesetzt, sind aber auch für viele weitere Industrieanwendungen geeignet. Die Schaltgeschwindigkeit ist weitgehend unabhängig von der eigentlichen Betätigungsgeschwindigkeit. Die nach ISO 9001:2000 zertifizierte Fertigung und die 100% funktionale Endkontrolle garantieren die zuverlässige Funktion. Bei diesen Schaltern haben wir unsere langjährige Erfahrung und Zuverlässigkeit im Schalterbau eingebracht.

Micro switches, also known as snap action switches, are primarily used as limit switches, but are also suitable for many other industry applications. The actual switching speed is completely independent from the speed of operation. ISO 9001:2000 approved production together with 100% functional final inspection and testing guarantee reliable operation. These products reflect our long standing experience in design and production of high quality switches.

MECHANISCHE KENNWERTE	MECHANICAL DATA	
Mech. Lebensdauer	Mech. lifetime	2 000 000 Schaltungen / 2 000 000 actuations
Sonderausführung 3,5N	Special version 3.5N	10 000 000 Schaltungen / 10 000 000 actuations
Elektr. Lebensdauer	Electrical lifetime	min. 50 000 Schaltungen / min. 50 000 actuations
abhängig von Schaltleistung	depending on switching capacity	
Differenzweg	Movement differential	siehe Übersicht nächste Seite / please see overview next page
Vorlaufweg	Pretravel	siehe Übersicht nächste Seite / please see overview next page
Nachlaufweg	Overtravel	siehe Übersicht nächste Seite / please see overview next page
Schaltpunkt	Operating position	siehe Übersicht nächste Seite / please see overview next page
Kontaktöffnungsweite	Contact opening	<3mm
SONSTIGE KENNWERTE	OTHER DATA	
Zulassungen	Approvals	ENEC-VDE, cULus
MATERIAL	MATERIAL	
Gehäuse	Housing	PBT/PET (UL94-V0)
Deckel	Cover	PBT/PET (UL94-V0)
Betätiger	Actuator	Phenolic (UL94-V0)
Anschlüsse	Terminals	CuZn versilbert / CuZn Ag plated
Kontakte	Contacts	AgNi
Kontaktgeber	Contact spring	CuBe

MAB1 Roller lever

2 SCHALTLEISTUNG / RATING

	cULus		Code: MAB1	01	3	4	5	6	7	8	9
1(0,3)A 250VAC	1A 125VAC		MAB1	01	3	4	5	6	7	8	9
5(2)A 250VAC	5A 125VAC		MAB1	02	3	4	5	6	7	8	9
10(3)A 250VAC	10A 125VAC		MAB1	03	3	4	5	6	7	8	9
16(4)A 250VAC	16A 125VAC		MAB1	04	3	4	5	6	7	8	9

3 BETÄTIGUNGSKRAFT / OPERATING FORCE

			Code: MAB1	2	A	4	5	6	7	8	9
0,8N		MAB1	2	A	4	5	6	7	8	9	
1,0N		MAB1	2	B	4	5	6	7	8	9	
1,5N		MAB1	2	C	4	5	6	7	8	9	
2,0N		MAB1	2	D	4	5	6	7	8	9	
2,5N		MAB1	2	E	4	5	6	7	8	9	
3,0N		MAB1	2	F	4	5	6	7	8	9	
3,5N		MAB1	2	G	4	5	6	7	8	9	
4,0N		MAB1	2	H	4	5	6	7	8	9	

EMPFOHLENE KOMBINATIONEN / RECOMMENDED COMBINATIONS

	0,8N	1,0N	1,5N	2,0N	2,5N	3,0N	3,5N	4,0N
1(0,3)A 250VAC	■	■	■	■	■	■		■
5(2)A 250VAC	■	■	■	■	■	■		■
10(3)A 250VAC		■	■	■	■	■		■
16(4)A 250VAC			■	■	■	■	■	■

4 UMGEBUNGSTEMPERATUR / AMBIENT TEMPERATURE

-10...+105°C		Code: MAB1	2	3	01	5	6	7	8	9
-10...+125°C		Code: MAB1	2	3	02	5	6	7	8	9

5 KONTAKTANORDNUNG / CONTACT ARRANGEMENT

Öffner / Normally closed Code: MAB1 2 3 4 A 6 7 8 9	Schließer / Normally open Code: MAB1 2 3 4 B 6 7 8 9	Wechsler / Change-over Code: MAB1 2 3 4 C 6 7 8 9
--	---	--

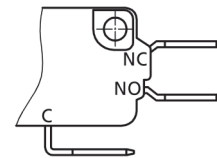
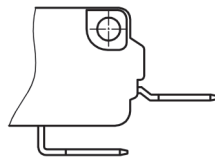
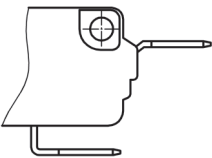

6 BETÄTIGER / ACTUATOR

Rolle kurz / Roller lever short Code: MAB1 2 3 4 5 06 7 8 9	Rolle lang / Roller lever long Code: MAB1 2 3 4 5 07 7 8 9	Simulierte Rolle / Simulated roller Code: MAB1 2 3 4 5 08 7 8 9
--	---	--

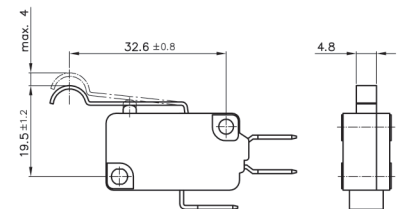
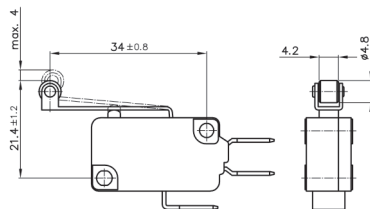
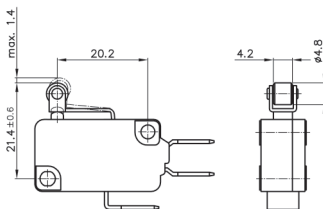

7 EINHÄNGEPUNKT / FIXING POSITION

vorne / front Code: MAB1 2 3 4 5 6 A 8 9	hinten / rear Code: MAB1 2 3 4 5 6 B 8 9
---	---

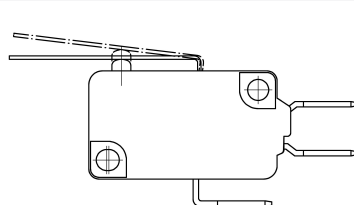
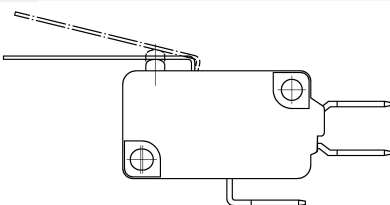

=auf Anfrage / upon request

MAB1 Rolle

8 ANSCHLÜSSE / TERMINALS

Steckanschluss 0,8x6,3mm / Plug connection

Code: MAB1 2 3 4 5 6 7 01 9

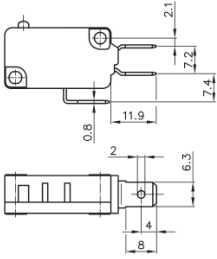

Steckanschluss 0,5x4,7mm / Plug connection

Code: MAB1 2 3 4 5 6 7 02 9

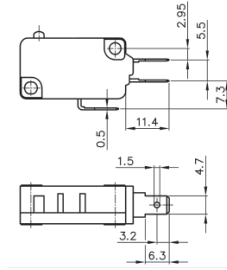

Steckanschluss 0,8x4,7mm / Plug connection

Code: MAB1 2 3 4 5 6 7 03 9

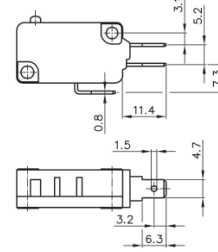

Steck/Lötan. 0,5x4,7mm /

Plug/solder terminal

Code: MAB1 2 3 4 5 6 7 04 9

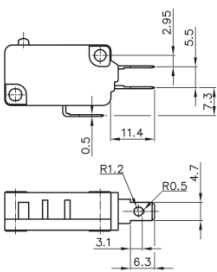

LP-Anschluss links / PCB terminal left

Code: MAB1 2 3 4 5 6 7 05 9

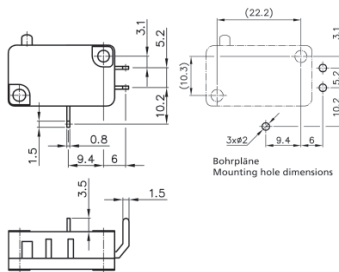

LP-Anschluss rechts / PCB terminal right

Code: MAB1 2 3 4 5 6 7 06 9

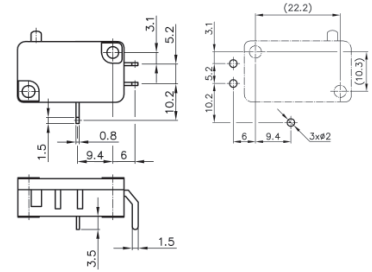

Lötöse / Solder terminal

Code: MAB1 2 3 4 5 6 7 07 9

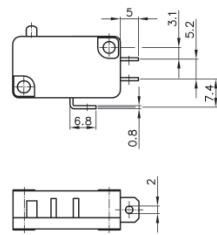

Schraubanschluss / Screw terminal

Code: MAB1 2 3 4 5 6 7 08 9

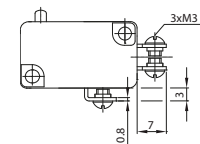

Rast 5 / Pin spacing 5

Code: MAB1 2 3 4 5 6 7 09 9

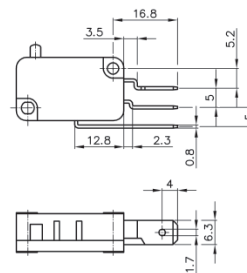

9 KONTAKTÖFFNUNG / CONTACT GAP

<3mm (Standard)

Code: MAB1 2 3 4 5 6 7 8 A

=auf Anfrage / upon request

= auf Anfrage / on request

Weitere Informationen finden Sie im Internet: www.hartmann-codier.de

Technische Änderungen vorbehalten / Specifications are subject to change without notice.

MAB1 Roller lever

ÜBERSICHT BETÄTIGER / WEGE / KRÄFTE OVERVIEW ACTUATORS / TRAVEL / FORCES

		Zusatzbetätigerlänge Actuator length	Betätigungskraft am Stoßel Operating force on plunger	Betätigungskraft am Zusatzbetätiger Operating force on lever	Vorlaufweg Pretravel	Nachlaufweg Overtravel	Differenzweg Movement differential	Ruhestellung Free position	Schaltpunkt Operating position	
Einhängepunkt vorne / Fixing position front	Code	mm	≤ N	Code	≤ N	≤ mm	min. mm	≤ mm	≤ mm	mm
Rolle kurz Roller lever short	06	25,6	0,8	A	0,69	2,4	1,5	0,8	25,5	22,5±0,6
			1,0	B	0,87					
			1,5	C	1,30					
			2,0	D	1,74					
			2,5	E	2,17					
			3,0	F	2,60					
			3,5	G	3,00					
			4,0	H	3,48					
	Code	mm	≤ N	Code	≤ N	≤ mm	min. mm	≤ mm	≤ mm	mm
Rolle lang Roller lever long	07	39,4	0,8	A	0,45	5,6	2,5	1,2	30,8	24,0±1,2
			1,0	B	0,56					
			1,5	C	0,84					
			2,0	D	1,12					
			2,5	E	1,40					
			3,0	F	1,68					
			3,5	G	0,95					
			4,0	H	2,25					
	Code	mm	≤ N	Code	≤ N	≤ mm	min. mm	≤ mm	≤ mm	mm
Simulierte Rolle Simulated roller lever	08	38,2	0,8	A	0,47	5,6	2,5	1,2	27,6	20,8±1,2
			1,0	B	0,59					
			1,5	C	0,88					
			2,0	D	1,18					
			2,5	E	1,47					
			3,0	F	1,76					
			3,5	G	2,06					
			4,0	H	2,35					
Einhängepunkt hinten / Fixing position rear	Code	mm	≤ N	Code	≤ N	≤ mm	min. mm	≤ mm	≤ mm	mm
Rolle kurz Roller lever short	06	20,2	0,8	A	0,90	1,4	1,0	0,4	23,4	21,4 ±0,6
			1,0	B	1,10					
			1,5	C	1,60					
			2,0	D	2,20					
			2,5	E	2,66					
			3,0	F	3,20					
			3,5	G	3,72					
			4,0	H	4,25					
	Code	mm	≤ N	Code	≤ N	≤ mm	min. mm	≤ mm	≤ mm	mm
Rolle lang Roller lever long	07	34	0,8	A	0,40	4,0	2,0	1,0	26,6	21,4 ±1,2
			1,0	B	0,50					
			1,5	C	0,80					
			2,0	D	1,00					
			2,5	E	1,30					
			3,0	F	1,60					
			3,5	G	1,87					
			4,0	H	2,14					
	Code	mm	≤ N	Code	≤ N	≤ mm	min. mm	≤ mm	≤ mm	mm
Simulierte Rolle Simulated roller lever	08	32,6	0,8	A	0,43	4,0	2,0	1,0	24,7	19,5 ±1,2
			1,0	B	0,54					
			1,5	C	0,81					
			2,0	D	1,08					
			2,5	E	1,35					
			3,0	F	1,62					
			3,5	G	1,89					
			4,0	H	2,16					

Von der Idee bis zur Produktion
From the idea to production

Drehcodierschalter
Rotary Code Switches

DIP-Schalter
DIP-Switches

Schiebeschalter
Slide Switches

Schalter und Buchsen
Switches and jacks

Anzeigeelemente
LED-Elements

Microschalter
Micro Switches

Zweitaastcodierschalter
Dual Pushbutton Switches

Anhang
Appendix

1 Zubehör/Accessories

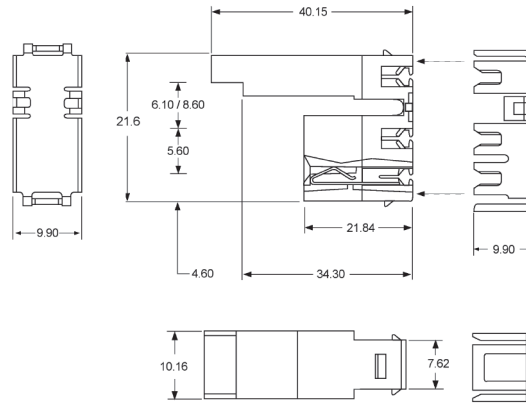
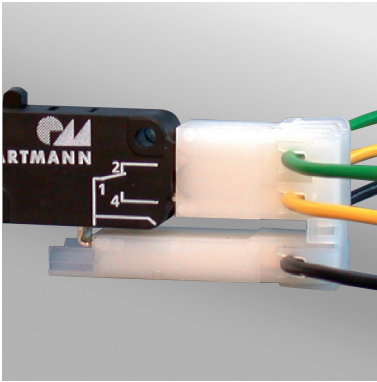

Stecker für Steckanschluss 0,5x4,7mm

- Alternative zu Einzelverdrahtung
- für End- und Durchgangsverbindungen
- zuverlässiger und schneller Schneidklemmanschluss
- zusätzliche Zugentlastungskappe montierbar
- servicefreundlich durch einfaches Aufstecken und Abziehen

Connector for Plug Connection 0.5x4.7mm

- alternative solution to discrete wiring
- for end- and feed-through connections
- reliable and fast IDC connection
- strain relief cap available
- easy on and easy off maintenance

MECHANISCHE KENNWERTE

Umgebungstemperatur	Ambient temperature	-55...+85°C
Zulassungen	Approvals	UL

MECHANICAL DATA

ELEKTRISCHE KENNWERTE

Stromtragfähigkeit	Current rating	
bei AWG18 (ca. 0,8mm ²)	for AWG18 (approx. 0.8mm ²)	10A
bei AWG20 (ca. 0,5mm ²)	for AWG20 (approx. 0.5mm ²)	6,5A
bei AWG22 (ca. 0,3mm ²)	for AWG22 (approx. 0.3mm ²)	6,5A
Prüfspannung	Test voltage	3,8kVAC
Isolationswiderstand	Insulation resistance	>5000MΩ

ELECTRICAL DATA

MATERIAL

Gehäuse	Housing	PA(UL94-V2)
Kontakte	Contacts	Phosphorbronze / Phosphor Bronze
Oberfläche	Plating	Zinn über Nickel / Tin over Nickel

MATERIAL

BESTELLBEZEICHNUNG / ORDERCODE

Stecker für AWG18 / Connector for AWG18	Code: SMA02 180301
Stecker für AWG20 / Connector for AWG20	Code: SMA02 200301
Stecker für AWG22 / Connector for AWG22	Code: SMA02 220301
Kappe für AWG18 / Cap for AWG18	Code: ZMA02 18
Kappe für AWG20, 22 / Cap for AWG20, 22	Code: ZMA02 20
Manuelles Montagewerkzeug / Manual fitting tool	Code: WMA02 M

1 Zubehör/Accessories

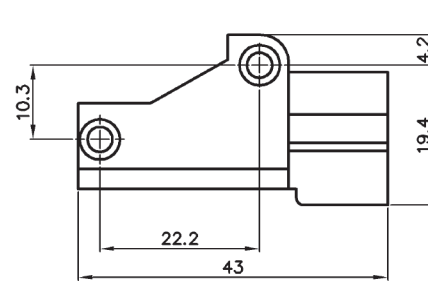
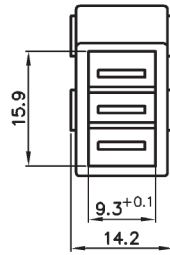

Adaptergehäuse für Rast5-Steckanschluss

- sichere Verbindung der Schalter mit dem Adaptergehäuse durch Befestigungsbohrungen

MATERIAL	MATERIAL	
Gehäuse	Housing	PBT
Farbe	Colour	schwarz / black

BESTELLBEZEICHNUNG / ORDERCODE

Adaptergehäuse / Adapter element
Code: Adaptergehäuse / Adapter element

Adapter element for Rast5-plug-connection

- reliable joining of switch and adapter element by fixing holes

X-ON Electronics

Largest Supplier of Electrical and Electronic Components

Click to view similar products for [Basic / Snap Action Switches](#) category:

Click to view products by [Apem](#) manufacturer:

Other Similar products are found below :

[5SM901-S12](#) [5SM9-S12N195](#) [602EN532](#) [602EN535-RB](#) [602HE5-RB1](#) [604HE162](#) [604HE223-6B](#) [624HE17-RB](#) [6HM82](#) [6HM89](#) [6SE1](#)
[6SX1-H58](#) [70500216](#) [70599106](#) [MBD5B1](#) [MBH2731](#) [73-316-0012](#) [EXD-AR20](#) [79211923](#) [79218589](#) [7AS12](#)
[MIL30126AB6BBMD4A12XAU](#) [ML-1155](#) [ML-1376](#) [831010C3.0](#) [831090C2.EL](#) [83131904](#) [84212012](#) [8AS239](#) [8HM73-3](#) [8SX26-H33](#)
[914CE1-6G](#) [PL-100](#) [11SM1077-H4](#) [11SM1077-H58](#) [11SM1-TN107](#) [11SM405](#) [11SM8423-H2](#) [11SX37-T](#) [11SX48-H58](#) [11SM2442-T](#)
[11SM76-T](#) [11SM77-H58](#) [11SM77-T](#) [11SM863-T](#) [11SM866](#) [A7CN-1M-1-LEFT](#) [A831700C7.0](#) [121EN187-R](#) [121EN188-R](#)