

MISCELLANEOUS HARDWARE & ACCESSORIES

SWITCH HARDWARE.....V2
PUSHBUTTON AND TOGGLE CAPS.....V2 - V3
SECURITY GUARDS.....V3

SPECIFICATIONS SUBJECT TO CHANGE WITHOUT NOTICE



MISCELLANEOUS HARDWARE

HEX NUT A112 Nickel plated brass
1/4-40

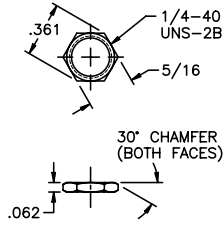

HEX NUT A465
Nickel plated brass 15/32-32

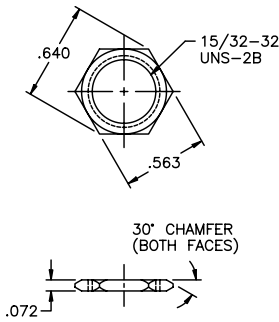

PANEL DRESS NUT A168P1
Blind thread, Nickel plated brass
1/4-40

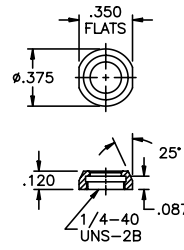

PANEL DRESS NUT A168P2
Thru thread, Nickel plated brass
1/4-40

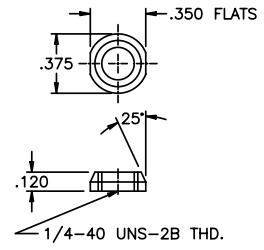

PANEL DRESS NUT A274
Nickel plated brass 1/4-40

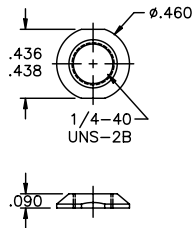

PANEL DRESS NUT A540
Nickel plated brass 15/32-32

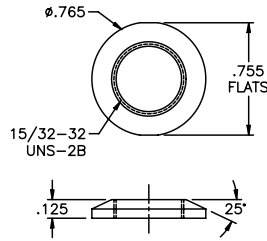

DECORATIVE NUT A447
Thru thread, chromium plated brass
1/4-40

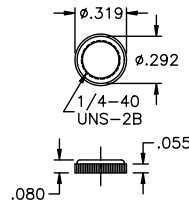

ANTI-ROTATE RING (LARGE) A158
Nickel plated brass 1/4

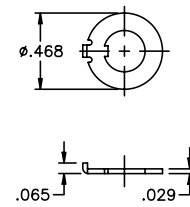

ANTI-ROTATE RING A482
Nickel plated brass 15/32

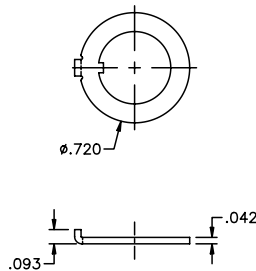

LOCKWASHER A115
Nickel plated steel 1/4

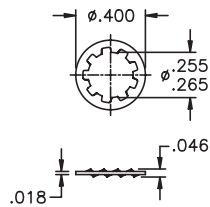

LOCKWASHER A466
Nickel plated steel 15/32

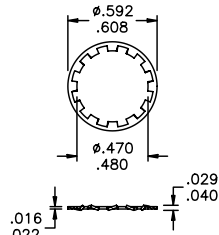

ANTI-ROTATE RING A107
Nickel plated brass 1/4

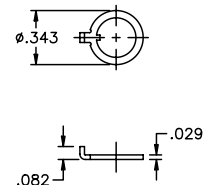

PUSHBUTTON CAPS (ALL)

Material - Nylon

Caps press fit adequately, however they may be pulled off. If permanent retention is required, cement with Loctite 405 or equivalent, insuring no cement enters switch.

PUSHBUTTON CAP A212

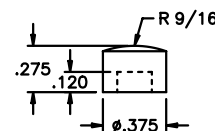

FITS PB SERIES

COLOR CAPS B366 & B497

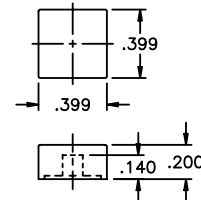

B366 fits 300 & 400 Series with S option only, and all PB Series.

B497 fits 800 Series with options KM, KS, KM1, K1M1 & K2M1.

PUSHBUTTON CAPS A180 & A496

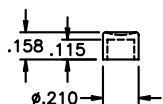

A180 fits all PB Series.
A496 fits 800 Series with options KM, KS, KM1, K1M1, K2M, K2S & K2M1.

PUSHBUTTON CAP A235

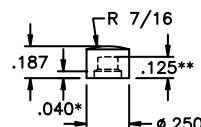

* - fits all PB, 300 & 400 Series.

** - fits 800 Series with options KM, KS, KM1 & K2M1.

STANDARD COLOR CODE

For nylon caps, actuators, bezels & bezel inserts. To specify, add selected color code to part number. Example: A2122 is a black A212 Cap. To specify for actuators, bezels and bezel inserts, see 'Order Format' section following specific series information in this catalog.

Code	Color	Code	Color
1	blue	2	black
3	green	4	gray
5	yellow	6	red
7	ivory	8	white
9	orange		

SPECIFICATIONS SUBJECT TO CHANGE WITHOUT NOTICE

MISCELLANEOUS HARDWARE (CONT'D.)

PUSHBUTTON CAP A420

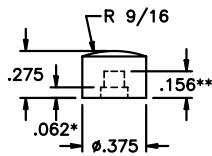

* - Fits all 300 Series except 301 & 305. Fits 301 & 305 with S option. Fits all 400 & PB Series.

** - Fits 800 Series with options KM, KS, KM1 & K2M1.

COLOR CAP B494

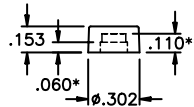

** - P1 fits all 800 Series except K1M & K1S.

* - P2 fits all 300 & 400 Series.

* - P3 fits all PB Series.

PUSHBUTTON CAP A631

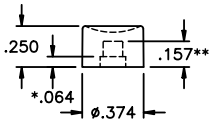

* - Fits all 300 Series except 301 & 305. Fits 301 & 305 with S option. Fits all 400 & PB Series.

** - Fits 800 Series with options KM, KS, KM1 & K2M1.

PUSHBUTTON CAP A632

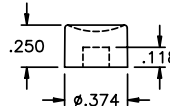

Fits all PB Series.

CUSTOM MARKING

Permanent ink marking is available for switch caps, bezels and rocker actuators. Consult factory with your special requirement. Representative samples available.

SWITCH GUARDS

Materials: 5056-H18 aluminum with clear or black anodize, or free machining brass with bright chrome plate. Dimensions in inches and (millimeters). Tolerances: A & D, ±.015" B & C, ±.005"

MODEL	TH'D.	COLOR	FINISH	A	B	C	D
MG11A	10-48	NATURAL AL.	PLAIN				
MG11B	10-48	BLACK AL.	PLAIN				
MG12A	1/4-40	NATURAL AL.	PLAIN				
MG12B	1/4-40	BLACK AL.	PLAIN	.530 (13.5)	.413 (10.5)	.315 (8.0)	.236 (6.0)
MG12C	1/4-40	CHROMED BR.	PLAIN				
MG12KA	1/4-40	NATURAL AL.	KNURLED				
MG12KB	1/4-40	BLACK AL.	KNURLED				
MG12KC	1/4-40	CHROMED BR.	KNURLED				
MG13A	1/4-40	NATURAL AL.	PLAIN				
MG13B	1/4-40	BLACK AL.	PLAIN	.730 (18.5)	.610 (15.5)	.315 (8.0)	.236 (6.0)
MG13C	1/4-40	CHROMED BR.	PLAIN				

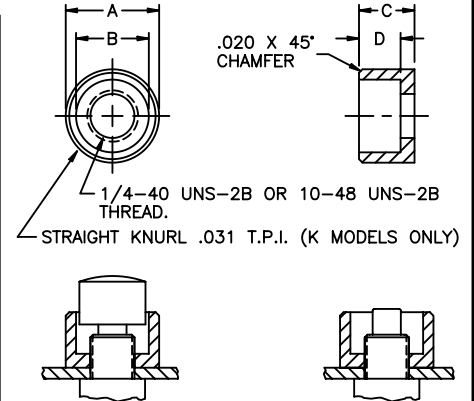

STANDARD COLOR CODE

For nylon caps, actuators, bezels & bezel inserts. To specify, add selected color code to part number. Example: A2122 is a black A212 Cap. To specify for actuators, bezels and bezel inserts, see 'Order Format' section following specific series information in this catalog.

Code	Color	Code	Color
1	blue	2	black
3	green	4	gray
5	yellow	6	red
7	ivory	8	white
9	orange		

SPECIFICATIONS SUBJECT TO CHANGE WITHOUT NOTICE

V

X-ON Electronics

Largest Supplier of Electrical and Electronic Components

Click to view similar products for [Switch Bezels / Switch Caps](#) category:

Click to view products by [Apem](#) manufacturer:

Other Similar products are found below :

[896809000](#) [LW1A-B2-R](#) [LW2A-B1-G](#) [704.604.4](#) [704.955.3](#) [F1403](#) [7527](#) [760203000](#) [760503000](#) [766601000](#) [785105000](#) [785106000](#)
[79211759](#) [MG12KB](#) [MH11](#) [MH13](#) [MHU31](#) [MJ1216](#) [MJ1226](#) [MJ33](#) [MJ612](#) [MJ626](#) [MJ627](#) [9001T8BK](#) [908-1634](#) [92-343.200](#) [92-343.400](#)
[95804.920](#) [95CAP-011](#) [95CAP-112](#) [11-932.7](#) [99-901.9](#) [99-902.9](#) [99-909.4](#) [99-909.5](#) [99-920.8](#) [A0261A](#) [11-931.2](#) [11-932.5](#) [11-936](#) [11-937](#)
[AKTSC22B](#) [AW-RF8](#) [161006](#) [1825068-6](#) [184-1872](#) [187-1872](#) [188-1471](#) [1DFBLK](#) [1D-GRY](#)