

MHPS SERIES KEY SWITCHES

FEATURES

- Double pole - double throw and 4 pole - double throw configurations.
- Momentary (non-locking) and maintained action (locking) models.
- Shorting and non-shorting contacts.
- Audible ('click') and non-audible action models.

GENERAL SPECIFICATIONS

Contact rating:	100 mA @ 30 VDC
Insulation resistance:	100 megohms minimum at 500 VDC
Dielectric withstanding voltage:	500 VAC for 1 minute
Contact resistance:	100 milliohms maximum
Life:	10,000 cycles minimum
Operating temperature range:	-20°C to +65°C

SOLDERING

Wave soldering:	260°C max. for 5 seconds maximum
Manual soldering:	350°C ± 10°C for 3 seconds maximum
Solvent washing:	Non-washable.

MATERIALS

Case:	PBT (model MHPS2266 only - Type 6/6 nylon)
Cover:	Acetal (model MHPS2266 only - Type 6/6 nylon)
Actuator:	Acetal
Terminals:	Silver plated brass
Shorting Contact:	Silver plated phosphor bronze

SPECIFICATIONS SUBJECT TO CHANGE WITHOUT NOTICE.

US # MHPS2266

Travel: full-.075" (1.9mm)
to lock-.039" (1mm)
Operating force: 140±50g



DOUBLE POLE

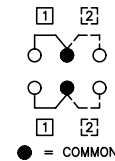
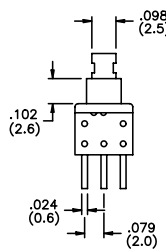
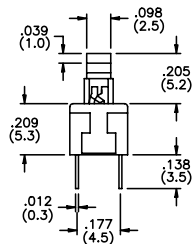
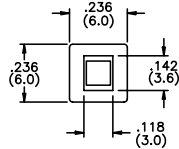

SCHEMATIC

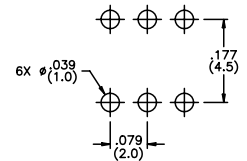

P.C. board layout

US Model No.	Action	Contacts	Audible
MHPS2266	maint'd.	non-sh't'g.	no
MHPS2266N	mom.	non-sh't'g.	no

US # MHPS2273 EU # PHAP4673

Travel: full-.071" (1.8mm)
to lock-.039" (1mm)
Operating force: 200gf ± 50gf



DOUBLE POLE

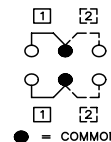
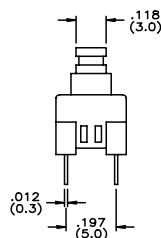
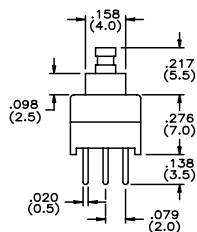
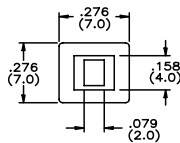

SCHEMATIC

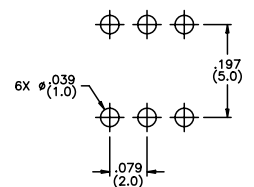

P.C. board layout

US Model No.	Action	Contacts	Audible	EU Model No.
MHPS2273	maint'd.	non-sh't'g.	no	PHAP4673
MHPS2273N	mom.	non-sh't'g.	no	N/A

US # MHPS2283
EU # PHAP4683W

Travel: full-.098" (2.5mm)
to lock-.059" (1.5mm)
Operating force: 180±50g



DOUBLE POLE

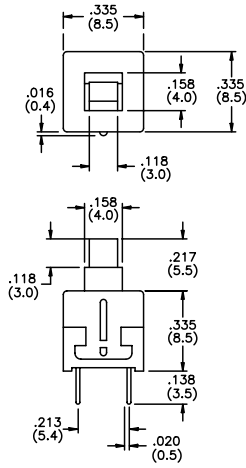

US Model No.	Action	Contacts	Audible	EU Model No.
MHPS2283	maint'd.	non-sht'g.	yes	PHAP4683W
MHPS2283N	mom.	non-sht'g.	no	N/A
MHPS2283V	mom.	non-sht'g.	yes	PHAP4383V

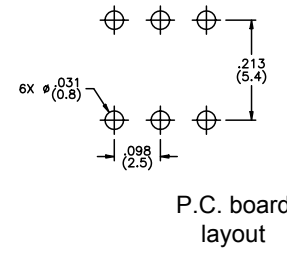
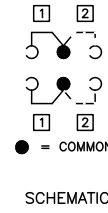

US # MHPS2285

Travel: full-.098" (2.5mm)
to lock-.059" (1.5mm)
Operating force: 180±50g



DOUBLE POLE

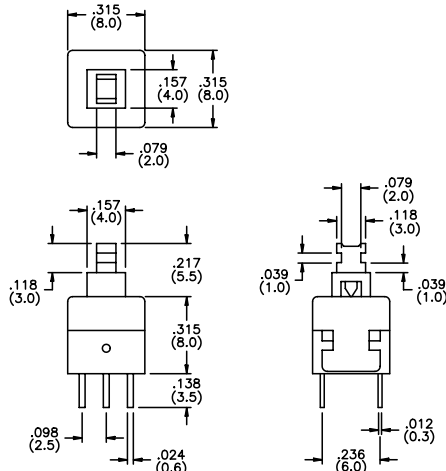

Model No.	Action	Contacts	Audible
MHPS2285	maint'd.	non-sht'g.	yes
MHPS2285N	mom.	non-sht'g.	no
MHPS2285V	mom.	non-sht'g.	yes

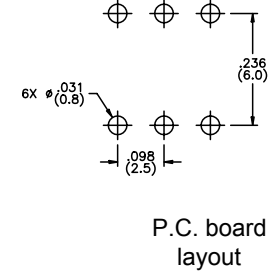
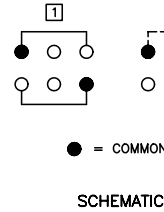

US # MHPS4284

Travel: full-.098" (2.5mm)
to lock-.059" (1.5mm)
Operating force: 180g
+100g, -50g



FOUR POLE

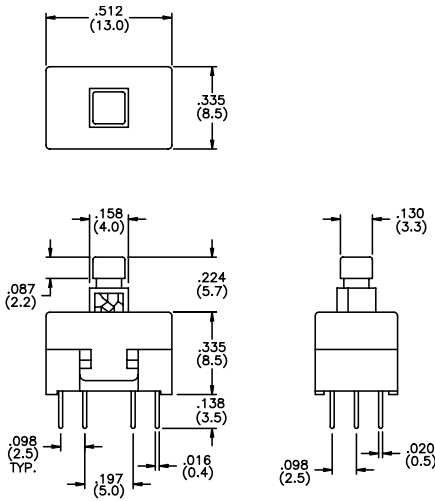

Model No.	Action	Contacts	Audible
MHPS4284	maint'd.	non-sht'g.	no
MHPS4284N	mom.	non-sht'g.	no
MHPS4284V	mom.	non-sht'g.	yes

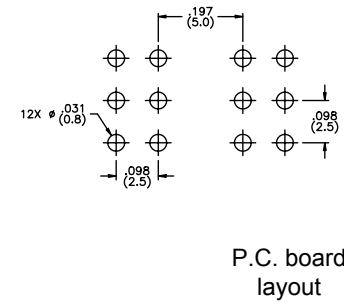
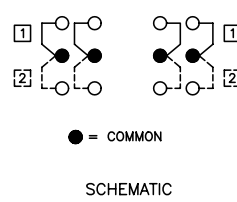

CAPS (fit MHPS2273, MHPS2283 and MHPS2285 models only)

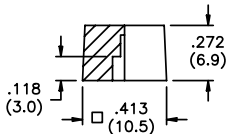

MH1 Square cap

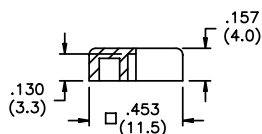

U4520 Square cap

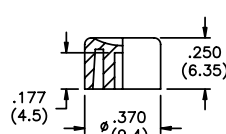

U4530 Round cap

Note - add digit from table to cap part number for color.
Example - **MH12** indicates black cap.

No.	Color
1	blue
2	black
3	green
5	yellow
6	red
7	ivory

SPECIFICATIONS SUBJECT TO CHANGE WITHOUT NOTICE.

X-ON Electronics

Largest Supplier of Electrical and Electronic Components

Click to view similar products for [Switch Bezels / Switch Caps](#) category:

Click to view products by [Apem](#) manufacturer:

Other Similar products are found below :

[896809000](#) [LW1A-B2-R](#) [LW2A-B1-G](#) [704.604.4](#) [704.955.3](#) [F1403](#) [7527](#) [760203000](#) [760503000](#) [766601000](#) [785105000](#) [785106000](#)
[79211759](#) [MG12KB](#) [MH11](#) [MH13](#) [MHU31](#) [MJ1216](#) [MJ1226](#) [MJ33](#) [MJ612](#) [MJ626](#) [MJ627](#) [9001T8BK](#) [908-1634](#) [92-343.200](#) [92-343.400](#)
[95804.920](#) [95CAP-011](#) [95CAP-112](#) [11-932.7](#) [99-901.9](#) [99-902.9](#) [99-909.4](#) [99-909.5](#) [99-920.8](#) [A0261A](#) [11-931.2](#) [11-932.5](#) [11-936](#) [11-937](#)
[AKTSC22B](#) [AW-RF8](#) [161006](#) [1825068-6](#) [184-1872](#) [187-1872](#) [188-1471](#) [1DFBLK](#) [1D-GRY](#)