

NDS-DP-DA series

DIP switches

Distinctive features and specifications

UG1410A

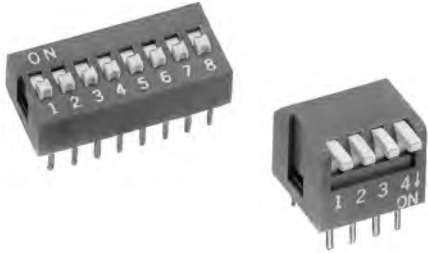

- Standard, piano and right angle models
- 1 to 12 positions
- Top tape sealing option

ELECTRICAL SPECIFICATIONS

- Current/voltage rating : 25mA 24VDC
- Initial contact resistance : 50mΩ max.
- Insulation resistance (at 500VDC) : 100 MΩ min. between adjacent terminals
- Dielectric strength : 500VDC for one minute
- Circuit : single pole, single throw
- Electrical life : 2.000 cycles min. per switch

MATERIALS

- Case, UL94-V0, glass fiber filled PBT, black
- Cover : UL94-V0, glass fiber filled PBT, red
- Actuator : UL94-V0, glass fiber filled PBT, white
- Terminals/contacts : gold over nickel plated phosphor bronze
- Terminal seal : epoxy
- Tape seal : polyester film

GENERAL SPECIFICATIONS

- Operating force :
 - NDS/DA models : 10N
 - DP models : 4N
- Travel :
 - NDS/DA : 2 mm (.078)
 - DP models : 30°
- Operating temperature :
 - DP/DA models : -20°C to +70°C
 - NDS models : -40°C to +85°C

RECOMMENDED SOLDERING AND CLEANING PROCESSES

- Hand soldering : 320°C max. for 2 seconds max. (30 watt iron max.)
- Wave soldering : 260°C max. for 5 seconds max.
- Force rinse, high agitation or triple bath cleaning method (**with tape seal, option T**) : freon TF or TE. When vapor methods are used, do not subject switch to solvents above 51°C.

Note : keep switches in "OFF" position during soldering and cleaning for best results.

Dimensions : first dimensions are in mm while inches are shown as bracketed numbers.



Packaging unit : standard IC tubes - Quantities depending on model. See table below.

NDS(R)	Quantity	NDS(R)-T	Quantity	DA	Quantity	DA-T	Quantity	DP/DPL	Quantity	DP-T/DPL-T	Quantity
NDS(R)-01	120	NDS(R)-01T	113	DA-02	73	DA-02T	70	DP(L)-02	70	DP(L)-02T	65
NDS(R)-02	72	NDS(R)-02T	70	DA-03	52	DA-03T	50	DP(L)-03	50	DP(L)-03T	49
NDS(R)-03	51	NDS(R)-03T	50	DA-04	40	DA-04T	39	DP(L)-04	39	DP(L)-04T	39
NDS(R)-04	40	NDS(R)-04T	39	DA-05	33	DA-05T	32	DP(L)-05	32	DP(L)-05T	32
NDS(R)-05	32	NDS(R)-05T	32	DA-06	28	DA-06T	28	DP(L)-06	27	DP(L)-06T	27
NDS(R)-06	27	NDS(R)-06T	27	DA-07	24	DA-07T	24	DP(L)-08	21	DP(L)-08T	21
NDS(R)-07	24	NDS(R)-07T	24	DA-08	21	DA-08T	21	DP(L)-10	17	DP(L)-10T	17
NDS(R)-08	21	NDS(R)-08T	21	DA-09	19	DA-09T	19	DP(L)-12	14	DP(L)-12T	14
NDS(R)-09	19	NDS(R)-09T	19	DA-10	17	DA-10T	17				
NDS(R)-10	17	NDS(R)-10T	17	DA-12	14	DA-12T	14				
NDS(R)-12	14	NDS(R)-12T	14								

The company reserves the right to change specifications without notice.

NDS/NDSR series

Standard DIP switches

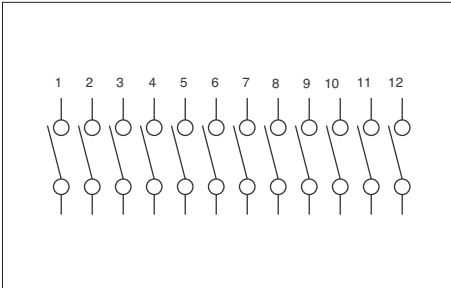

- Raised or recessed actuator
- 1 to 12 positions

MODEL STRUCTURE



Raised actuator : NDS



Model No	No. pos.	Dim. "A"	Dim. "B"
NDS-01	1	4,22 (.166)	-
NDS-02	2	6,44 (.253)	2,54 (.100)
NDS-03	3	8,98 (.353)	5,08 (.200)
NDS-04	4	11,52 (.453)	7,62 (.300)
NDS-05	5	14,06 (.553)	10,16 (.400)
NDS-06	6	16,60 (.653)	12,70 (.500)
NDS-07	7	19,14 (.753)	15,24 (.600)
NDS-08	8	21,68 (.853)	17,78 (.700)
NDS-09	9	24,22 (.953)	20,32 (.800)
NDS-10	10	26,76 (1.053)	22,86 (.900)
NDS-12	12	31,84 (1.253)	27,94 (1.100)

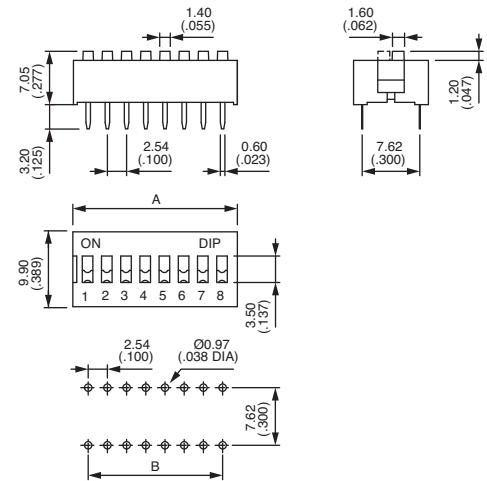

Top tape sealed : add "T" after model number.

Recessed actuator : NDSR



Model No	No. pos.	Dim. "A"	Dim. "B"
NDSR-01	1	4,22 (.166)	-
NDSR-02	2	6,44 (.253)	2,54 (.100)
NDSR-03	3	8,98 (.353)	5,08 (.200)
NDSR-04	4	11,52 (.453)	7,62 (.300)
NDSR-05	5	14,06 (.553)	10,16 (.400)
NDSR-06	6	16,60 (.653)	12,70 (.500)
NDSR-07	7	19,14 (.753)	15,24 (.600)
NDSR-08	8	21,68 (.853)	17,78 (.700)
NDSR-09	9	24,22 (.953)	20,32 (.800)
NDSR-10	10	26,76 (1.053)	22,86 (.900)
NDSR-12	12	31,84 (1.253)	27,94 (1.100)

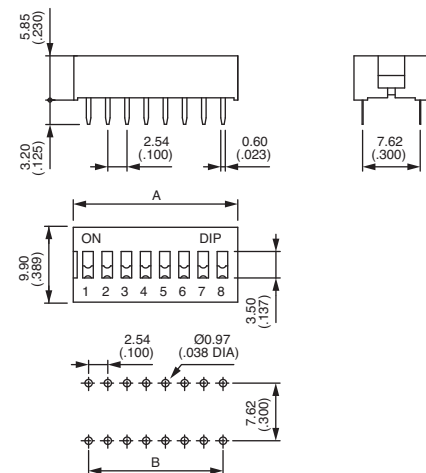

Top tape sealed : add "T" after model number.

F

DP/DPL series

Piano DIP switches

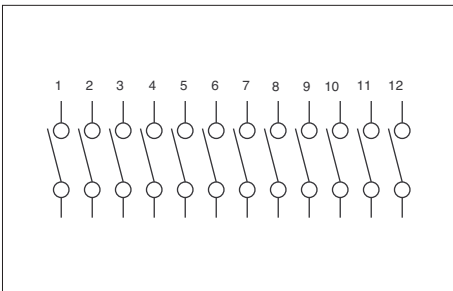

- Short or long actuator
- 2 to 12 positions

Note : Push down for "ON" is our standard type.
Push down for "OFF" is also available on special order, consult factory.

MODEL STRUCTURE



Short actuator : DP

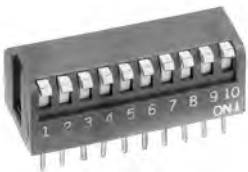

Model No	No. pos.	Dim "A"	Dim. "B"
DP-02	2	6,44 (.253)	2,54 (.100)
DP-03	3	9,18 (.361)	5,08 (.200)
DP-04	4	11,72 (.461)	7,62 (.300)
DP-05	5	14,26 (.561)	10,16 (.400)
DP-06	6	16,80 (.661)	12,70 (.500)
DP-08	8	21,88 (.861)	17,78 (.700)
DP-10	10	26,96 (1.061)	22,86 (.900)
DP-12	12	32,04 (1.261)	27,94 (1.100)

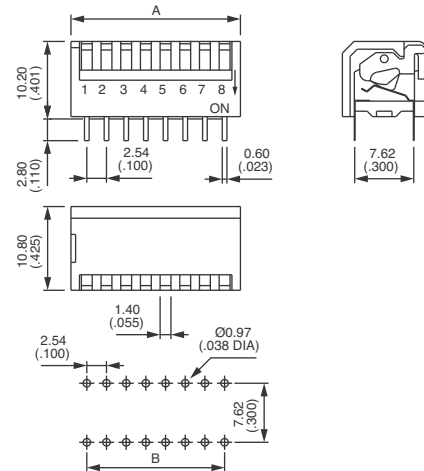

Top tape sealed : add "T" after model number.

Long actuator : DPL



Model No	No. pos.	Dim "A"	Dim. "B"
DPL-02	2	6,44 (.253)	2,54 (.100)
DPL-03	3	9,18 (.361)	5,08 (.200)
DPL-04	4	11,72 (.461)	7,62 (.300)
DPL-05	5	14,26 (.561)	10,16 (.400)
DPL-06	6	16,80 (.661)	12,70 (.500)
DPL-08	8	21,88 (.861)	17,78 (.700)
DPL-10	10	26,96 (1.061)	22,86 (.900)
DPL-12	12	32,04 (1.261)	27,94 (1.100)

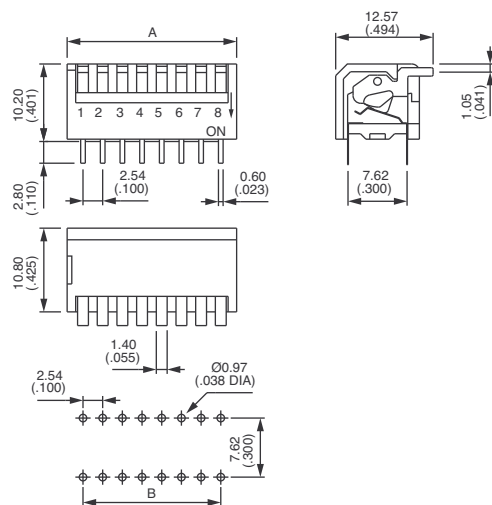

Top tape sealed : add "T" after model number.



DA series

Right angle DIP switches

- 2 to 12 positions

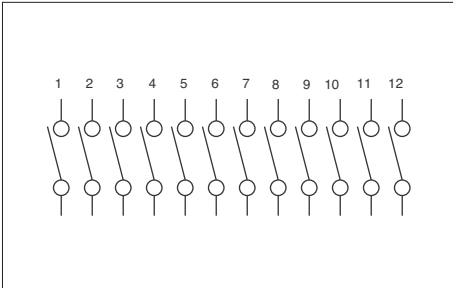

**MODEL
STRUCTURE**



Raised actuator : DA



Model No	No. pos.	Dim "A"	Dim. "B"
DA-02	2	6,44 (.253)	2,54 (.100)
DA-03	3	8,89 (.350)	5,08 (.200)
DA-04	4	11,52 (.453)	7,62 (.300)
DA-05	5	14,06 (.553)	10,16 (.400)
DA-06	6	16,60 (.653)	12,70 (.500)
DA-07	7	19,14 (.753)	15,24 (.600)
DA-08	8	21,68 (.853)	17,78 (.700)
DA-09	9	24,22 (.953)	20,32 (.800)
DA-10	10	26,76 (1.053)	22,86 (.900)
DA-12	12	31,84 (1.253)	27,94 (1.100)

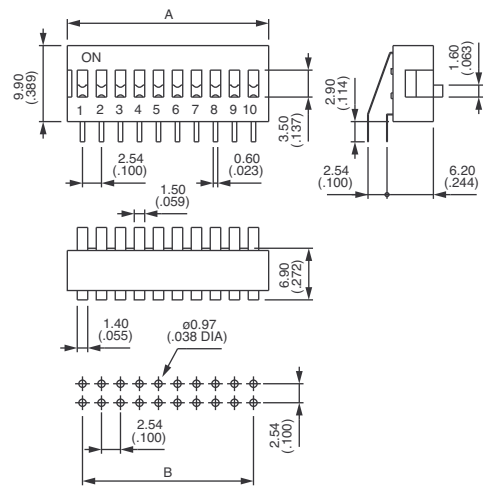

Top tape sealed : add "T" after model number.

F

X-ON Electronics

Largest Supplier of Electrical and Electronic Components

Click to view similar products for [DIP Switches/SIP Switches](#) category:

Click to view products by [Apem](#) manufacturer:

Other Similar products are found below :

[78M03S](#) [79B10T](#) [8136-475G4T](#) [G7G-1A2-CB-DC12](#) [A7SS-M](#) [DBP 2110](#) [DBP 2112](#) [DBS1008](#) [DHN02FTVTR](#) [DHN10T](#) [DHS108](#)
[DPL08TN](#) [DRD16CSE04](#) [DRR4010](#) [DRR60016](#) [DRS4016](#) [BD06E](#) [1825008-1](#) [1825444-1](#) [25.350.0653.0](#) [LA2-DC12](#) [SBS 5004 TG](#)
[SDA10H1BDA](#) [97R06ST](#) [A2C-2A5](#) [1825444-7](#) [ADE08SA04](#) [ADE12S04](#) [2161391-1](#) [2-1825058-8](#) [CCVA 2.5/ 4-G-5.08](#) [P26THRR32](#)
[25.330.0653.1](#) [25.352.0353.0](#) [MDG305ST](#) [IKN0600000](#) [IKN0800000](#) [LA2-002-DC24](#) [DBP2008](#) [DBS1003](#) [DBS2008](#) [438872000](#)
[DRD10CRAE04](#) [DRS1604](#) [DSR02T](#) [DSS 208 N](#) [5-1825033-1](#) [106-SDN06-EV](#) [1-1437507-6](#) [E2FMX2D1M1TGJ03M](#)
[E3ZMCT81M1TJ03M](#)