

PT65 series

Rotary code switches

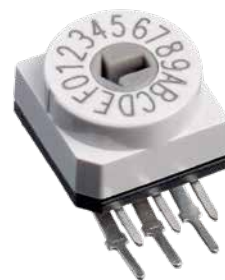

DISTINCTIVE FEATURES

4 actuator types

Sub-miniature size

Solder and flux sealed, washable



ENVIRONMENTAL SPECIFICATIONS

- Operating temperature: -20 °C to +70 °C (-4 °F to +167 °F)



ELECTRICAL SPECIFICATIONS

- Operating voltage : ≤ 42 V
- Contact load, static : ≤ 0.2 A
- Contact load, dynamic : ≤ 0.15 A
- Initial contact resistance : 80 m Ω max.
- Insulation resistance : 100 M Ω min.



MECHANICAL SPECIFICATIONS

- Torque : 0.7 Ncm min
- Expected life : 10,000 cycles min.



MATERIALS

- Base : UL94-V0, high temperature thermoplastic
- Cover : UL94-V0, high temperature thermoplastic
- Actuator : PA 4.6 nylon
- Contacts : gold over nickel plated phosphor bronze
- Terminals : tin plated

The company reserves the right to change specifications without notice.



PT65 series

Rotary code switches



SOLDERING

- DIN CEI 68-2-20
- Manual soldering : 340 °C (644 °F) max. for 2 seconds max.
- Wave soldering : 280 °C (536 °F) max. for 5 seconds max.



PACKAGING

- Switches for screwdriver slot or accessory actuation (PT651 and PT657) : tubes of 50 pieces
- Switches with spindle (PT653) or segment wheel (PT655) : trays of 50 pieces
- Accessories : bags of 50 pieces



PCB MOUNTING

PCB STRAIGHT

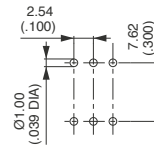

PCB RIGHT ANGLE 2.54

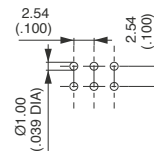

PCB RIGHT ANGLE 5.08

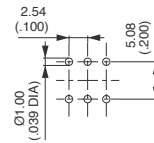

PT65 series

Rotary code switches



BUILD YOUR PART NUMBER

PT65

SERIES

ACTUATORS

CODES

TERMINALS

1 Screwdriver

3 Spindle

5 Segment wheel

7 Accessories

01 BCD

02 BCD complement

03 Hexadecimal

06 Hexadecimal complement

(none) Straight

L254 Right angle, spacing 2.54 (.100)

L508 Right angle, spacing 5.08 (.200)

AVAILABLE AS STANDARD PRODUCTS

	SCREWDRIVER		SPINDLE	SEGMENT WHEEL		ACCESSORIES
	Upper actuation	Side actuation	Upper actuation	Upper actuation	Side actuation	Upper actuation
BCD	PT65101	PT65101L254 PT65101L508	PT65301	PT65501	-	PT65701
BCD COMPLEMENT	PT65102	-	-	PT65502	-	-
HEXADECIMAL	PT65103	PT65103L254 PT65103L508	PT65303	PT65503	PT65303L254	-
HEXADECIMAL COMPLEMENT	PT65106	-	-	-	-	-

SCREWDRIVER SLOT - STRAIGHT TERMINALS

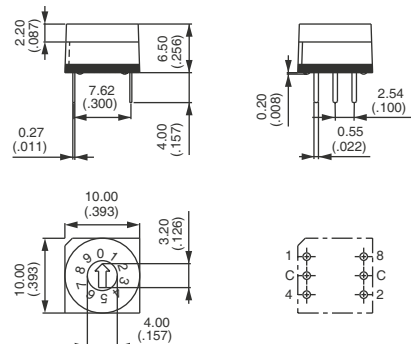

PT65 series

Rotary code switches

ACTUATORS



- 1 Screwdriver
- 3 Spindle (grey)
- 8 Segment wheel (grey)
- 7 Accessories (see next page)

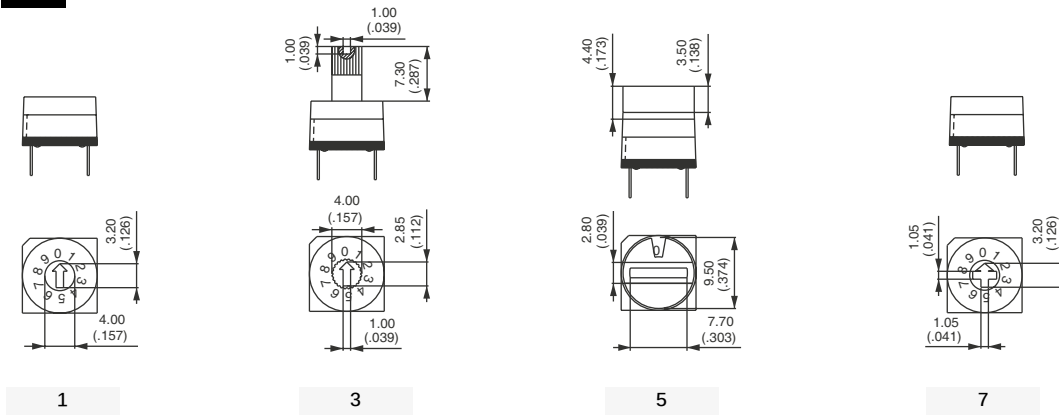

CODES

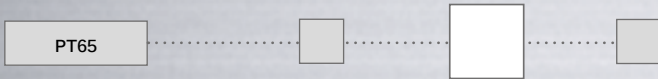

- 01 BCD
- 02 BCD complement
- 03 Hexadecimal
- 06 Hexadecimal complement

POSITION	C	1	2	4	8	MARKING
0	●					0
1	●	●				1
2	●		●			2
3	●	●	●			3
4	●			●		4
5	●	●			●	5
6	●		●	●		6
7	●	●	●	●		7
8	●				●	8
9	●	●			●	9

01

POSITION	C	1	2	4	8	MARKING
0	●	●	●	●	●	0
1	●		●	●	●	1
2	●	●		●	●	2
3	●			●	●	3
4	●	●	●		●	4
5	●		●		●	5
6	●	●			●	6
7	●				●	7
8	●	●	●	●		8
9	●		●	●		9

02

POSITION	C	1	2	4	8	MARKING
0	●					0
1	●	●				1
2	●		●			2
3	●	●	●			3
4	●			●		4
5	●	●		●		5
6	●		●	●		6
7	●	●	●	●		7
8	●				●	8
9	●	●			●	9
10	●		●		●	10
11	●	●	●		●	11
12	●		●	●		12
13	●	●		●	●	13
14	●		●	●	●	14
15	●	●	●	●	●	15

03

POSITION	C	1	2	4	8	MARKING
0	●	●	●	●	●	0
1	●		●	●	●	1
2	●	●		●	●	2
3	●			●	●	3
4	●	●	●		●	4
5	●		●		●	5
6	●	●			●	6
7	●				●	7
8	●	●	●	●		8
9	●		●	●		9
10	●	●		●		10
11	●			●		11
12	●	●	●			12
13	●		●			13
14	●	●				14
15	●					15

06

PT65 series

Rotary code switches

TERMINALS

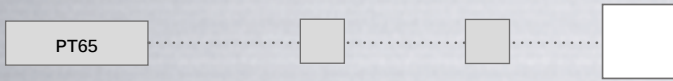

- (none) Straight
- L254 Right angle, spacing 2.54 (.100)
- L508 Right angle, spacing 5.08 (.200)

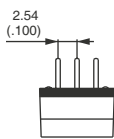
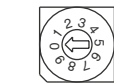
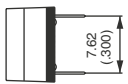

(none)

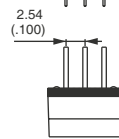
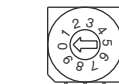

L254

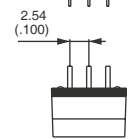
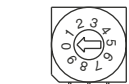

L508

ACCESSORIES

To order separately.

ACCESSORIES ADAPTED TO YOUR APPLICATIONS

Basic model PT657 has been designed to accept different actuators with snap-in connection.

According to your application, you can choose between spindles or plastic knobs in two different lengths and a Ø 17 mm (.669) knurled wheel for lateral marking.

Standard colours are shown below. Special colours are also available on request.

		P/N	COLORS	DIMENSIONS
SPINDLES	Length 11.6 mm (standard)	U4822	black	
		U4824	grey	
	Length 13.3 mm	U4832	black	
PLASTIC KNOBS	Length 5.3 mm (standard)	U4906	red	
	Length 15.7 mm	U4916	red	
	Length 4.4 mm	U4941	blue	
		U4943	green	
		U4944	grey	
		U4945	yellow	
		U4946	red	
KNURLED WHEEL (unmarked - marking on request)		U4847/1	white/black	

X-ON Electronics

Largest Supplier of Electrical and Electronic Components

Click to view similar products for [Coded Rotary Switches](#) category:

Click to view products by [Apem](#) manufacturer:

Other Similar products are found below :

[PT65SG178](#) [PT65SG23](#) [DRS4010](#) [CW1S-2E11](#) [S-1031A](#) [SBS1004](#) [P36S101TR](#) [P65THR101L254](#) [RM3AF-10R-V-T/R](#) [RH3HAF-10R-V-B](#)
[PT65501RT](#) [P25SMT101TR](#) [P65SMT101](#) [P65THR101V](#) [MSDR-10H1](#) [GSDR-10S](#) [01-1433](#) [07-3153](#) [07-3154](#) [CRD10CM0SBR](#) [DRS4116](#)
[94HCB16RAT](#) [94HCB10T](#) [94HBB16WT](#) [94HBB16RAT](#) [94HBB10WT](#) [94HBB10RAT](#) [94HBB08RAT](#) [94HAC10T](#) [94HAB16WT](#)
[94HAB16T](#) [94HAB10WT](#) [94HAB10RAT](#) [94HAB08WT](#) [94HAB08RAT](#) [ND3FR10P](#) [ND3FR16B-R](#) [DRR3110](#) [94HEB08WRT](#)
[94HCB16WT](#) [94HCB16T](#) [94HCB10RAT](#) [94HCB08T](#) [94HBB16T](#) [94HBB10T](#) [94HBB08T](#) [94HAB16RAT](#) [94HAB10T](#) [94HAB08T](#) [S-2011A](#)