

# multimec® 3F + 1D/1E/1F

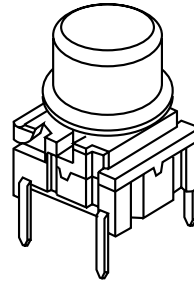

### Technical Data:

- through-hole or SMD
- 50mA/24VDC
- single pole/momentary
- 10.000.000 operations life time
- IP67 sealing
- temperature range:  
low temp: -40/+115°C  
high temp: -40/+160°C

### Dimensions (through-hole)

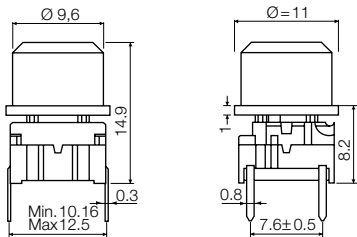

### PCB layout

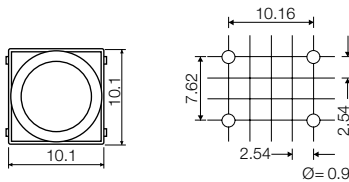

### Dimensions (w/LED)

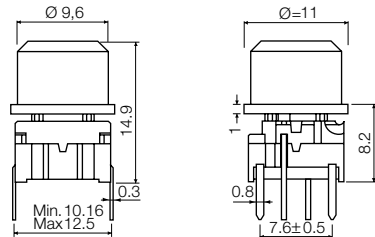

### PCB layout (top view)

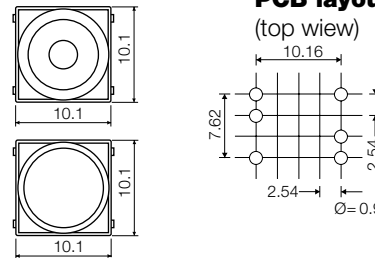

### Dimensions (SMD)

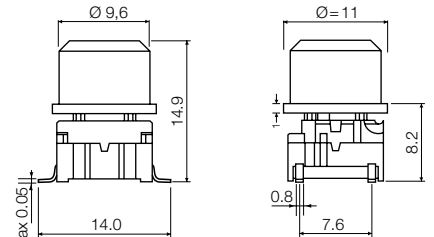

### PCB layout

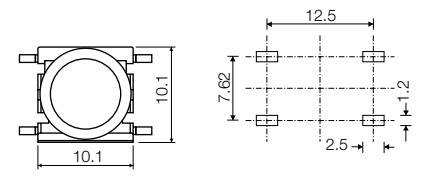



### HOW TO ORDER

<b>3 F</b>	<input type="checkbox"/>	<input type="checkbox"/>	<b>+</b>	<input type="checkbox"/>	<input type="checkbox"/>	<input type="checkbox"/>	<input type="checkbox"/>	
<b>Switch</b>	<b>Mounting</b>	<b>L 6</b> low temp.		<b>1 D</b>	<b>Cap</b>	<b>00</b> blue	<b>30</b> ultra blue	<b>50</b> metal dark blue
	<b>T</b> through-hole	<b>H 9</b> high temp.				<b>02</b> green	<b>40</b> dusty blue	<b>53</b> metal light grey
	<b>S</b> surface mount					<b>03</b> grey	<b>42</b> aqua blue	<b>57</b> metal dark grey
						<b>04</b> yellow	<b>32</b> mint green	<b>58</b> metal bordeaux
						<b>06</b> white	<b>33</b> tele grey	
						<b>08</b> red	<b>34</b> melon	
						<b>09</b> black	<b>38</b> noble red	

### Standard versions:

3FTL6  
3FTH9  
3FSH9  
3FSH9R

<b>3 F</b>	<b>T</b>	<input type="checkbox"/>	<b>+</b>	<input type="checkbox"/>	<input type="checkbox"/>	<input type="checkbox"/>	<input type="checkbox"/>
<b>Switch</b>	<b>Mounting</b>	<b>L 6</b> low temp.		<b>LED</b>	<b>Cap 1D</b>	<b>1 1</b>	<b>Lens</b>
	<b>T</b> through-hole	<b>H 9</b> high temp.		<b>00</b> blue		transparent	
				<b>20</b> green	<b>Cap 1E</b>	<b>00</b> blue	<b>1</b> transparent
				<b>40</b> yellow		<b>02</b> green	<b>2</b> green
				<b>80</b> red	<b>Cap 1F</b>	<b>03</b> grey	<b>4</b> yellow
				<b>2040</b> green/yellow		<b>04</b> yellow	<b>8</b> red
				<b>8020</b> red/green		<b>06</b> white	
				<b>8040</b> red/yellow		<b>08</b> red	
						<b>09</b> black	

Ordering example: 3FTL620 + 1E032

# multimec® 3F + 1K + 2K

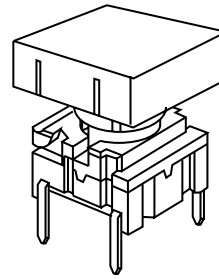
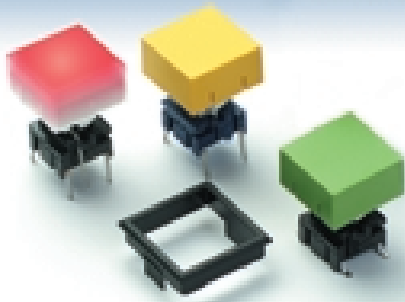

### Technical Data:

- through-hole or SMD
- 50mA/24VDC
- single pole/momentary
- 10.000.000 operations life time
- IP67 sealing
- temperature range:  
low temp: -40/+115°C  
high temp: -40/+160°C

### Dimensions (through-hole)

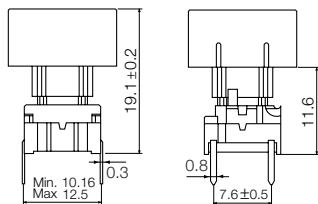

### PCB layout

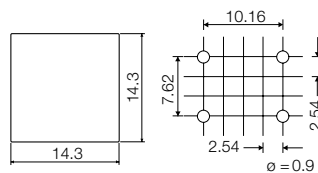

### Dimensions (w/LED)

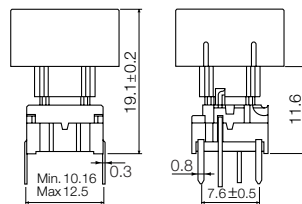

### PCB layout (top view)

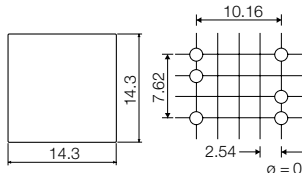

### Dimensions (SMD)

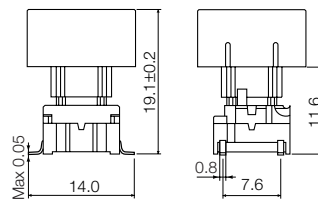

### PCB layout

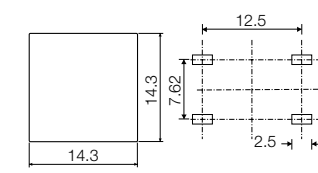

### Dimensions (Bezel) (Optional)

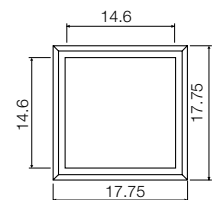
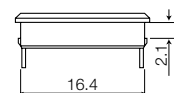

### HOW TO ORDER

<b>3 F</b>	<input type="checkbox"/>	<input type="checkbox"/>	+	<b>1 K</b>	<b>1 6</b>	+	<b>2 K</b>	<input type="checkbox"/>
<b>Switch</b>	<b>Mounting</b>	<b>L 6</b> low temp. <b>H 9</b> high temp.		<b>Cap</b>	<b>00</b> blue <b>02</b> green <b>03</b> grey <b>04</b> yellow <b>06</b> white <b>08</b> red <b>09</b> black		<b>Bezel</b>	<b>03</b> grey <b>06</b> white <b>08</b> red <b>09</b> black

### Standard versions:

- 3FTL6
- 3FTH9
- 3FSH9
- 3FSH9R

<b>3 F</b>	<b>T</b>	<input type="checkbox"/>	<input type="checkbox"/>	+	<b>1 K 1 1 1 6</b>	+	<b>2 K</b>	<input type="checkbox"/>
<b>Switch</b>	<b>Mounting</b>	<b>L 6</b> low temp. <b>H 9</b> high temp.	<b>LED</b>		<b>Cap</b> transparent		<b>Bezel</b>	<b>03</b> grey <b>06</b> white <b>08</b> red <b>09</b> black
	<b>T</b> through-hole		<b>23</b> green <b>44</b> yellow <b>88</b> red					

### Standard versions:

- 3FTL622
- 3FTL644
- 3FTL688

**Ordering example:** 3FTL688 + 1K1116

# multimec® 3F + 1P/1Q/1R

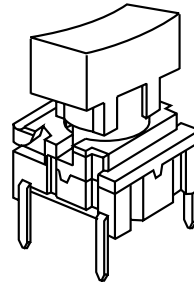

## Technical Data:

- through-hole or SMD
- 50mA/24VDC
- single pole/momentary
- 10.000.000 operations life time
- IP67 sealing
- temperature range:  
low temp: -40/+115°C  
high temp: -40/+160°C

### Dimensions (through-hole)

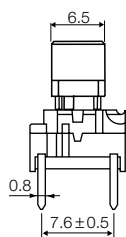
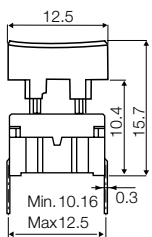

### PCB layout

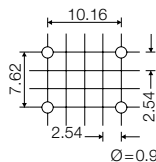
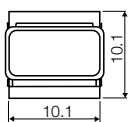

### Dimensions (w/LED)

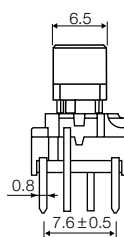
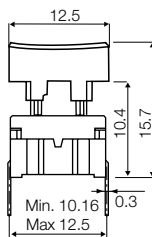

### PCB layout (top view)

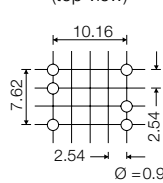
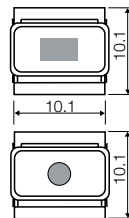

### Dimensions (SMD)

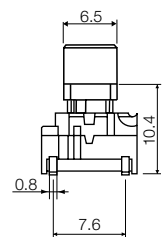
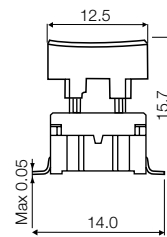

### PCB layout

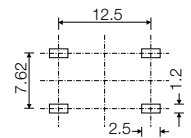
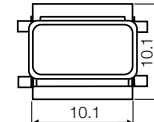

## How to order

**3 F**

**Switch**



**Mounting**

**T** through-hole  
**S** surface mount



**L 6** low temp.  
**H 9** high temp.

+

**1 P**

**Cap**



**00** blue  
**02** green  
**03** grey  
**04** yellow  
**06** white  
**08** red  
**09** black

### Standard versions:

3FTL6  
3FTH9  
3FSH9  
3FSH9R

**3 F**

**Switch**



**Mounting**

**T** through-hole



**L 6** low temp.  
**H 9** high temp.

+

**LED**

**00** blue  
**20** green  
**40** yellow  
**80** red  
**2040** green/yellow  
**8020** red/green  
**8040** red/yellow

**1 Q**



**00** blue  
**03** grey  
**08** red  
**09** black

**1**

**Lens**  
**1** transparent

### Standard versions:

3FTL600  
3FTL620  
3FTL640  
3FTL680  
3FTL62040  
3FTL68020  
3FTL68040

**1 R**



**Ordering example:** 3 FTL680 + 1Q091

# multimec® RAS + 1D/1K/1P/1S

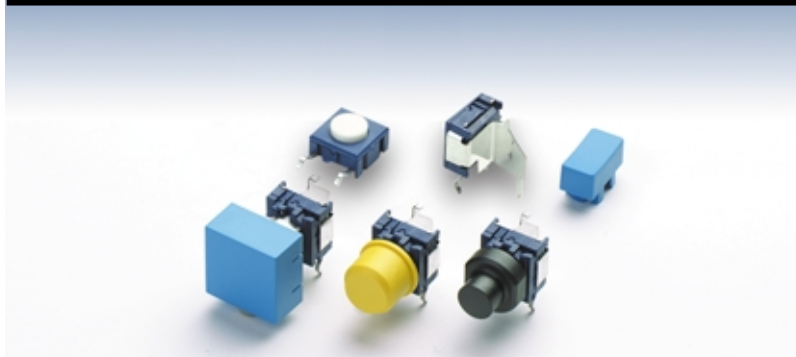

## Technical Data:

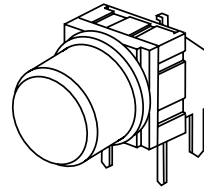

- through-hole only
- 50mA/24VDC
- single pole/momentary
- 10.000.000 operations life time
- IP67 sealing
- temperature range:  
low temp: -40/+115°C

### Dimensions 1D

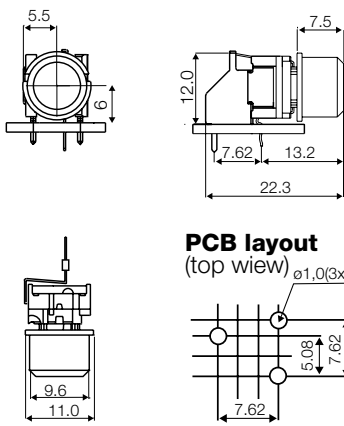

### Dimensions 1K

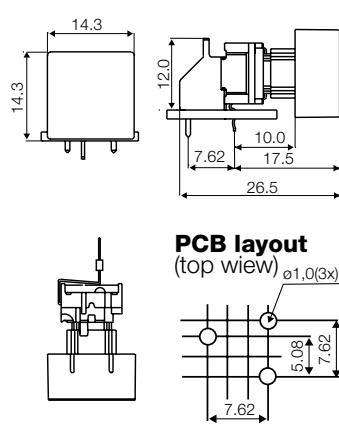

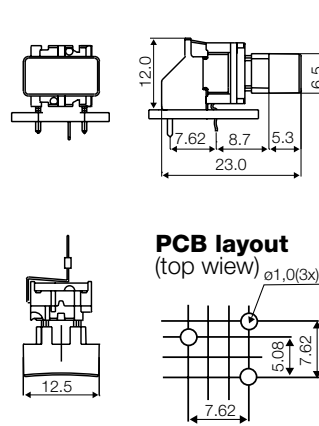

### Dimensions 1P

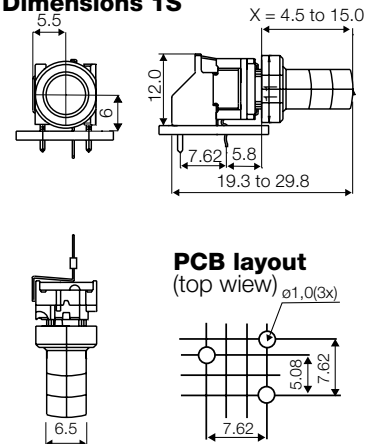

### Dimensions 1S

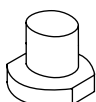

## HOW TO ORDER

<b>3 F</b>	<b>T</b>	<b>L 6</b>	<b>R A S</b>	+	<b>1 D</b>			
<b>Switch</b>	<b>Mounting</b>	<b>L 6</b> low temp.	<b>Right angle support</b>		<b>Cap</b>	<b>00</b> blue	<b>30</b> ultra blue	<b>50</b> metal dark blue
	<b>T</b> through-hole					<b>02</b> green	<b>40</b> dusty blue	<b>53</b> metal light grey
						<b>03</b> grey	<b>42</b> aqua blue	<b>57</b> metal dark grey
						<b>04</b> yellow	<b>32</b> mint green	<b>58</b> metal bordeaux
						<b>06</b> white	<b>33</b> tele grey	
						<b>08</b> red	<b>34</b> melon	
						<b>09</b> black	<b>38</b> noble red	
					<b>1 P</b>	<b>00</b> blue		
						<b>03</b> grey		
						<b>08</b> red		
						<b>09</b> black		
					<b>1 K</b>	<b>1 6</b>	+	<b>2 K</b>
						<b>Cap</b>	<b>00</b> blue	<b>Bezel</b>
						<b>02</b> green	<b>03</b> grey	<b>03</b> grey
						<b>03</b> grey	<b>04</b> yellow	<b>06</b> white
						<b>04</b> yellow	<b>06</b> white	<b>08</b> red
						<b>06</b> white	<b>08</b> red	<b>09</b> black
						<b>08</b> red		
						<b>09</b> black		
					<b>1 S 0 9</b>	<b>Cap black</b>	<b>H</b>	<b>X *</b>
							16.0	8.5
							19.0	11.5
							22.5	15.0

**Standard versions:**  
3FTL6RAS, 3CTL6RAS,

\*Any cap height X from 8.5 to 15.0 mm is available. Please order 1S09-H, where H = X+7.5 mm  
Min. order Qty for custom heights is 2.000 pcs. A start-up charge will apply.  
3CTL6 also available as right angle switch 3CTL6RAS. Please see multimec basic switch modules.

**Ordering example:** 3FTL6RAS + 1K0016 + 2K03

Through-hole Version						
3A	3C	3E	3F	3F	3F	3F
For 1A/1B/1M	w/LED for 1C/1H			For 1D/1K/1N/1P/1S/1T/1U/1V/1X/1GA/1GC	w/LED for 1E/1F/1N/1Q/1R/1S/1X	w/LED for 1K1116/1T/1U/1V
<b>Standard Versions</b>						
3ATL6 3ATH9	3ATL600/20/40/80	3CTL6/3CTL9 3CTH9	3ETL9-H* 3ETH9-H*	3FTL6 3FTH9	3FTL600/20/40/80/ 2040/8020/8040	3FTL623/44/88
* 3E available in 6 standard heights: 08.0, 09.5, 10.4, 11.0, 12.0, 15.0 mm Other heights between 08.0 and 15.0 mm are available upon request						
Specials: Gold contacts, quiet version and actuation force other than 3.0N						

Surface Mount Versions			
3A	3C	3E	3F
3ASH9/3ASH9R	3CSH9/3CSH9R	3ESH9/3ESH9R	3FSH9 / 3FSH9R
For 1A/1B/1M			For 1D/1K/1N/1P/1S/1T/1U/1V/1X/1GA/1GC

Right Angle Versions	
3C	3F
3CTL6RAS	3FTL6RAS
	For 1D/1K/1P/1S

### multimec® Cross Section

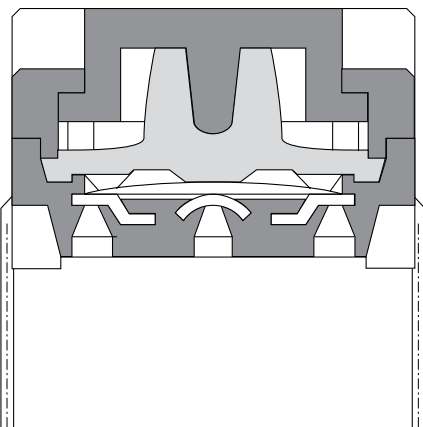

### Recommended PCB layout

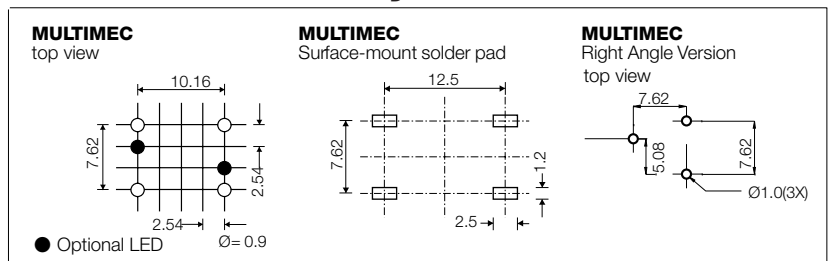

**Operating Force**  
(Typical example)

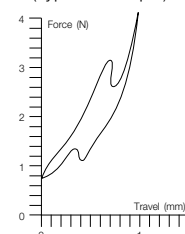

**Circuit diagram**

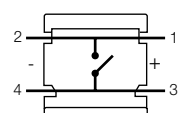

DIMENSIONS (mm) Unless otherwise specified, all tolerances  $\pm 0.2$

	Low Temperature Versions		High Temperature Versions	
	Silver	Gold	Silver	Gold
<b>Electrical Specifications</b>				
Contact resistance	<30 mΩ - typically 10mΩ			
Insulation resistance	>10M Ω			
Recommended load	0.5-50mA 24VDC	0.5μ-50mA 24VDC	0.5-50mA 24VDC	0.5μ-50mA 24VDC
Contact bounce	<2mS - typically 0.5mS			
<b>Mechanical Specifications</b>				
Standard actuation force (switch)	3.0N typ.			
Max. actuation force without cap	100N for 10 sec.			
Key travel (switch)	1 mm			
Life time (switch)	>10.000.000 cycles			
<b>Temperature Range</b>				
Working temperature	Min. -40°C Max. +115°C		Min. -40°C Max. +160°C	
Storage temperature	Min. -40°C Max. +115°C		Min. -40°C Max. +160°C	
Soldering IEC 68-2-20	Wave -max. 260°C for max. 10 sec., please refer to usage guidelines		Infrared, vapour phase, wave - max. 260°C for max. 30 sec.	
	Soldering iron - max. 350°C for max. 3 sec. Flux tight.		Soldering iron - max. 350°C for max. 3 sec. Flux tight.	
<b>Environmental Endurance IEC-68-2-3</b>				
Temperature	+40°C			
Humidity	93% RH			
Duration	56 Days			
<b>Temperature Cycling IEC 68-2-14</b>				
Temperature limit	Min. -55°C - Max. +85°C			
Number of cycles	200			
Exposure time at each temperature	10 min.			
Recovery time before measurements	16 hrs.			
Sealing IEC 529	IP-67			
Cleaning	Standard methods such as freon and water			
<b>Material Specifications - Switches</b>				
Housing	PBT UL94VO		PPS UL94VO	
Actuator	PBT UL94VO		PPS UL94VO	
Sealing + spring	Silicone rubber			
Contact spring	Stainless steel + 3μAg	Stainless steel + 3μAg + 1μAu	Stainless steel + 3μAg	Stainless steel + 3μAg + 1μAu
Fixed Contacts	SnCu + 2μNi + 3μAg	SnCu + 2μNi + 3μAg + 1μAu	SnCu + 2μNi + 3μAg	SnCu + 2μNi + 3μAg + 1μAu
Terminals	SnCu + 2μNi + 3μSnPb	SnCu + 2μNi + 3μSnPb	SnCu + 2μNi + 3μSnPb	SnCu + 2μNi + 3μSnPb
<b>Material Specifications - Caps &amp; Bezels</b>				
<b>Material</b>	<b>Parts</b>	<b>Temp limit</b>	<b>UL rating</b>	
ABS Standard	Standard parts except the below mentioned	Max 65°C	UL94HB	
Polycarbonate	All lenses	Max. 85°C	UL94V1	
LCP	Actuator of 3E	Max. 160°C	UL94VO	
PPS	1S, 2S	Max. 160°C	UL94VO	
Polyamide	Actuator of Varimec , 1GA/ 1GC	Max. 160°C	UL94VO	
<b>Legends Adhesion</b>	ISO Class.: 1/ ASTM Class.: 4B DIN EN ISO 2409			

Specifications are subject to change without notice

Existing and New Part Nos. for Lead Free, RoHS compatible and Proces compatible mec products

**MULTIMEC**

Part No.	Part Name	Lead Free	RoHS Comp.	Proces Comp.	New Part No. Comments	Lead Free	RoHS Comp.	Proces Comp.	UL
3ASH9	Switch Surface Ag/High Temp	N	N	Y	RA3ASH9	Y	Y	Y	V0
3AXXXG	All 3A Switches with Au	N	N	Y	RA3AXXXG	Y	Y	Y	V0
3AXXXQ	All 3A Quiet Switches	N	N	Y	RA3AXXXQ	Y	Y	Y	VO
3ASH9R	All 3A Switches delivered on Tape	N	N	Y	RA3ASH9R	Y	Y	Y	V0
3ATH9	Switch Th Ag/High Temp.	N	N	Y	RA3ATH9	Y	Y	Y	V0
3ATL6	Switch Th Ag/White But/Low Temp.	N	N	Y	RA3ATL6	Y	Y	Y	V0
3ATL6 w/LED	Switch Th Ag/Low Temp w/LED	N	N	Y	RA3ATL6 w/LED	Y	Y	Y	V0
3CSH9	Switch Surface Ag/High Temp.	N	N	Y	RA3CSH9	Y	Y	Y	V0
3CXXXG	All 3C Switches with Au	N	N	Y	RA3CXXXG	Y	Y	Y	V0
3CXXXQ	All 3C Quiet Switches	N	N	Y	RA3CXXXQ	Y	Y	Y	V0
3CSH9R	All 3C Switches delivered on Tape	N	N	Y	RA3CSH9R	Y	Y	Y	V0
3CTH9	Switch Th Ag/High Temp	N	N	Y	RA3CTH9	Y	Y	Y	V0
3CTL6	Switch Th/White But/Low Temp	N	N	Y	RA3CTL6	Y	Y	Y	V0
3CTL6-2SL	Switch Low Temp. 2 Straight Legs	N	N	Y	RA3CTL6-2SL	Y	Y	Y	V0
3CTL6RAS	Right Angle Switch Low Temp.	N	N	Y	RA3CTL6RAS	Y	Y	Y	V0
3CTL9	Switch Th Ag/Black But/Low Temp	N	N	Y	RA3CTL9	Y	Y	Y	V0
3ESH9	Switch Surface Ag High Temp.	N	N	Y	RA3ESH9	Y	Y	Y	V0
3ESH9-XX.X	Switch Ag/High Temp./w Actuator	N	N	Y	RA3ESH9-XX.X	Y	Y	Y	V0
3EXXXG	All 3E Switches with Au	N	N	Y	RA3EXXXG	Y	Y	Y	V0
3EXXXQ	All 3E Quiet Switches	N	N	Y	RA3EXXXQ	Y	Y	Y	V0
3ESH9R	All 3E Switches delivered on Tape	N	N	Y	RA3ESH9R	Y	Y	Y	V0
3ETH9	Switch Th Ag High Temp.	N	N	Y	RA3ETH9	Y	Y	Y	V0

3ETH9-XX.X	Switch Th Ag/High Temp. w/Actuator	N	N	Y	RA3ETH9-XX.X	Y	Y	Y	V0
3ETL9	Switch Th Ag/Low Temp.	N	N	Y	RA3ETL9	Y	Y	Y	V0
3ETL9-XX.X	Switch Th Ag/Low Temp. w/Actuator	N	N	Y	RA3ETL9-XX.X	Y	Y	Y	V0
3FSH9	Switch Surface Ag/High Temp.	N	N	Y	RA3FSH9	Y	Y	Y	V0
3FXXXG	All 3F Switches with Au	N	N	Y	RA3FXXXG	Y	Y	Y	V0
3FXXXQ	All 3F Quiet Switches	N	N	Y	RA3FXXXQ	Y	Y	Y	V0
3FSH9R	All 3F Switches delivered on Tape	N	N	Y	RA3FSH9R	Y	Y	Y	V0
3FTH9	Switch Th Ag/High Temp.	N	N	Y	RA3FTH9	Y	Y	Y	V0
3FTH9 w/LED	Switch Th High Temp w/ LED	N	N	Y	RA3FTH9 w/LED	Y	Y	Y	V0
3FTL6	Switch Th Ag/Low Temp.	N	N	Y	RA3FTL6	Y	Y	Y	V0
3FTL6 w/LED	Switch Th Ag/Low Temp w/LED	N	N	Y	RA3FTL6 w/LED	Y	Y	Y	V0
3FTL6-2SL	Switch Low Temp. 2 Straight Legs	N	N	Y	RA3FTL6-2SL	Y	Y	Y	V0
3FTL6RAS	Right Angle Switch Low Temp.	N	N	Y	RA3FTL6RAS	Y	Y	Y	V0
1CXXXX	Leds for 1C or 1H Button	N	N	N	RA1CXXXX	Y	Y	Y	
2BXXXX	Leds for 2B Bezel	N	N	N	RA2BXXXX	Y	Y	Y	
3FXXXXX	Leds Bent for 3F	N	N	N	RA3FXXXXX	Y	Y	Y	
1AXX	DI Buttons all colours for 3A	Y	Y	N	No change, pls see note 1				HB
1BXX	DI Buttons f. Bezels all colours	Y	Y	N	No change, pls see note 1				HB
1CXXX	DI Buttons w/Lens all colours	Y	Y	N	No change, pls see note 1				HB
1DXX	Lk Buttons all colours	Y	Y	N	No change, pls see note 1				HB
1EXXX	Lk Buttons w/Lens all colours	Y	Y	N	No change, pls see note 1				HB
1FXXX	Lk Buttons w/Lens all colours	Y	Y	N	No change, pls see note 1				HB
1GA09	Cap black 11	Y	Y	Y	No change				V0
1GC09	Cap black 15	Y	Y	Y	No change				V0
1HXXX	DI Buttons w/Lens all colours	Y	Y	N	No change, pls see note 1				HB
1KXX	Lk Lid all colours	Y	Y	N	No change, pls see note 1				HB
1KXX16	Lid all colours/Lens/Reflector	Y	Y	N	No change, pls see note 1				HB



1KXX1	Lens Milky White For 1K Button	Y	Y	N	No change, pls see note 1			HB
1KXXX6	Reflector For 1K Button White	Y	Y	N	No change, pls see note 1			HB
1MXX	DI Button Double Width all colours	Y	Y	N	No change, pls see note 1			HB
1NXX	Teardrop Buttons all colours	Y	Y	N	No change, pls see note 1			HB
1PXX	Gf Buttons all colours	Y	Y	N	No change, pls see note 1			HB
1QXXX	1P But. W/Square Hole, all colours	Y	Y	N	No change, pls see note 1			HB
1RXXX	1P Button w/Round Hole, all colours	Y	Y	N	No change, pls see note 1			HB
1S09-XX.X	Lk Button Black, all heights	Y	Y	Y	No change			V0
1S11-XX.X	Lk Button Transparent, all heights	Y	Y	N	No change, pls see note 2			V1
1TXX	Sq. Button, all colours	Y	Y	N	No change, pls see note 1			HB
1UXX	Round Button, all colours	Y	Y	N	No change, pls see note 1			HB
1VXX	Arrow Button, all colours	Y	Y	N	No change, pls see note 1			HB
1X XX	Rectangular Button, all colours	Y	Y	N	No change, pls see note 1			HB
1ZAXX	DL Button, all colours	Y	Y	N	No change, pls see note 1			HB
1ZBXX	Curved Button, all colours	Y	Y	N	No change, pls see note 1			HB
1ZCXX	Round Button, all colours	Y	Y	N	No change, pls see note 1			HB
3E-XX.X	Actuator f. 3E Switch, all heights	Y	Y	Y	No change			V0
3E-AXXXX	Varimec cap 5.2 Round, all heights	Y	Y	Y	No change			V0
3E-BXXXX	Varimec cap 5.2 Square, all heights	Y	Y	Y	No change			V0
3E-EXXXX	Varimec cap 7.8 Round, all heights	Y	Y	Y	No change			V0
3E-FXXXX	Varimec cap 7.8 Square, all heights	Y	Y	Y	No change			V0
3E-KXXXX	Varimec cap 11.6 Round, all heights	Y	Y	Y	No change			V0
3E-LXXXX	Varimec cap 11.6 Square, all heights	Y	Y	Y	No change			V0
AQB01XX	Sealing Boot (incl. Sea.ring)	Y	Y	Y	No change			
AQB0111	Sealing Boot Trans. (incl. Sea.ring)	Y	Y	Y	No change			
AQC09-XX.X	Cap Black, all overall heights	Y	Y	Y	No change			V0
AQC11-XX.X	Cap Trans. all overall heights	Y	Y	N	No change, pls see note 2			V1

AQN-X.X	Bushing, all heights	Y	Y	Y	No change			
1CXXX	Lens f. 1C/1H/1Q Buttons, all colours	Y	Y	N	No change, pls see note 2			V1
1EXXX	Lens f. 1E Buttons, all colours	Y	Y	N	No change, pls see note 2			V1
1FXXX	Lens f. 1F Buttons, all colours	Y	Y	N	No change, pls see note 2			V1
1RXX1	Round Transparent Lens For 1R	Y	Y	N	No change, pls see note 2			V1
2AXX	DI Bezel, all colours	Y	Y	N	No change, pls see note 1			HB
2BXXX	Bezel/Lens, all colours	Y	Y	N	No change, pls see note 1			HB
2BXXX	Lens f. 2B Bezel, all colours	Y	Y	N	No change, pls see note 2			V1
2KXX	Lk Bezel f. 1K, all colours	Y	Y	N	No change, pls see note 1			HB
2RAS	Right Angle Support.	Y	Y	Y	No change			
2S09-XX.X	Extender, Black Pps, all heights	Y	Y	Y	No change			V0
1A09XDXXX	Button 1A Down/all legends	Y	Y	N	No change, pls see note 1			HB
1A09XUXXX	Button 1A Up/all legends	Y	Y	N	No change, pls see note 1			HB
1B09XDXXX	Button 1b Down/0	Y	Y	N	No change, pls see note 1			HB
1B09XUXXX	Button 1B Up/all legends	Y	Y	N	No change, pls see note 1			HB
1D09XXX	Round Button/all legends	Y	Y	N	No change, pls see note 1			HB
1F096XXX	1F Button/Inverse legends	Y	Y	N	No change, pls see note 1			HB
1ZB09XDXXX	Button1ZB09 Down / all legends	Y	Y	N	No change, pls see note 1			HB
1ZC09XXX	Button 1ZC09 / all legends	Y	Y	N	No change, pls see note 1			HB

**Note 1:** Complies with RoHS, however plastic material limited to 65°C.  
Accessories must be mounted after soldering.

**Note 2:** Complies with RoHS, however plastic material is limited to 85°C,  
so excessive proces heat must be avoided.

041213

041213

## **X-ON Electronics**

Largest Supplier of Electrical and Electronic Components

*Click to view similar products for [Apem manufacturer](#):*

Other Similar products are found below :

[009960B](#) [014823B](#) [014825R](#) [025773H](#) [03-0023](#) [099196G](#) [099313G](#) [099349E](#) [100113](#) [100114](#) [100133BX](#) [100350](#) [100550BLKRF](#)  
[100550GRYRF](#) [100600](#) [100-650](#) [10-1155](#) [1019C](#) [104350003](#) [104450003](#) [104450108](#) [106212](#) [106361175](#) [106362103](#) [106462103](#)  
[106492103](#) [109605](#) [10C0016](#) [10C0816](#) [10C0916](#) [10C1616LMH11809](#) [10C1616LMH12309](#) [10G00](#) [10G03](#) [10G08](#) [10G09](#) [10G36](#) [10Q03](#)  
[11136A](#) [11137AD2K](#) [11137AK](#) [11139A](#) [11139AK](#) [11146A](#) [11146X778](#) [11148AG](#) [11166AD2K](#) [1202A2](#) [12037A2ULCSA](#) [1203A2UL](#)