

TS series

Proportional miniature thumb controls •
non-contacting Hall effect technology



DISTINCTIVE FEATURES

- One or two axis
- Analog, PWM or USB outputs
- IP67 Above panel sealing mounting
- Rear or drop-in mounting
- Pushbutton option



ENVIRONMENTAL SPECIFICATIONS

- Operating Temperature: -40 °C to +85 °C (-40 °F to +185 °F)
- Storage Temperature: -40 °C to +85 °C (-40 °F to +185 °F)
- Above Panel Sealing: IP67, IP69K¹ (subject to mounting style & final specifications)
- EMC Immunity Level: EN61000-4-3
- EMC Emissions Level: EN61000-6-3:2001
- ESD: EN61000-4-2



SENSOR SPECIFICATIONS

- Technology: Hall effect sensors, single or dual
- Supply Voltage Range: 5.00 V ± 0.01 VDC
- Supply Current: 11 mA max
- Ratiometric Output Options: See options
- Reverse Polarity max: -10 V
- Transient overvoltage max: 16 V
- Start-up time: 15 ms max
- Output Impedance: 2Ω
- Return to Center Voltage Tolerance: ± 200 mV initial



U.S. Patent #D816,169 S
U.S. Patent #D732,047 S
U.S. Patent #D816,169 S
U.S. Patent #D734,138 S

The company reserves the right to change specifications without notice.

TS series

Proportional miniature thumb controls • non-contacting Hall effect technology



MECHANICAL SPECIFICATIONS

- Operating Force: 3.1 N ± 0.5 N (0.70 lbf ± 0.11 lbf)²
- Maximum Vertical Load: 200 N (45 lbf)²
- Maximum Horizontal Load: 150 N (33.7 lbf)²
- Mechanical Angle of Movement: 50° X & Y axis (subject to limiter plate)
- Expected Life: 1 million cycles
- Mass/Weight: 18.25 g ± 5.0 g (0.64 oz ± 0.18 oz)
- Lever Action (centering): Spring

¹ All options are IP68 and IP69K rated, however drop-in mounting does not prevent panel ingress.

² Force applied to the top of the castle cap.



MATERIALS

- Body: Glass filled nylon
- Threaded Housing: Black oxide plated brass
- Boot: Silicone
- Handles:
 - 1, 2, 3, E, F, G - Glass filled nylon
 - 4, 5, 6, 7, 8 - Silicone
 - B, C, D - Thermoplastic elastomer
 - H - Polycarbonate

APEM products may be recycled at end-of-life for the re-claiming of valuable metal components.



CONNECTIONS

WIRING SPECIFICATION
(Termination options 1 & 2)

Black	Ground & button common, or LED common
Red	Power (5 V) ¹
Blue	X axis output (alpha)
Yellow	Y axis output (alpha)
Orange	Pushbutton switch (option 6 handle) or LED supply (option H handle) ^{2 2}
Blue/White Stripe	X axis output (beta)
Yellow/Black Stripe	Y axis output (beta)
Red/White Stripe	Power (5 V) (beta)
Black/White Stripe	Ground (beta)

¹ Hall sensor and LED supply (LED control option 1)

² User controllable (LED control option 2)



PUSHBUTTON SWITCH SPECIFICATIONS (OPTION 6 HANDLE)

- Electrical Life: 100,000 cycles
- Rating: 50 mA, 12 VDC.
- Terminal: Brass with silver plating
- Contact Resistance: 100 mΩ max
- Insulation Resistance: 100 MΩ min. 500 VDC
- Dielectric Strength: 250 VAC /1 minute
- Contact Arrangement: 1 pole 1 throw
- Stop Strength: Max 3 kgf vertical static load for 15 seconds
- Operating Temperature: -25 °C to +70 °C (-4 °F to +158 °F)
- Storage Temperature: -30 °C to +85 °C (-22 °F to +158 °F)
- Vibration Resistance: MIL-STD-202F METHOD 201A
- Shock Resistance: MIL-STD-202F METHOD 213B



LED SPECIFICATIONS (OPTION H HANDLE)

LED CONTROL	OPERATING VOLTAGE	OPERATING CURRENT
1 – ON, driven by joystick supply voltage	-	6 mA
2 – User controlled	5 V	6 mA

Proportional miniature thumb controls • non-contacting Hall effect technology



NEW OPTIONS AVAILABLE

PLASTIC THREADED HOUSING



LED ILLUMINATION OPTION H HANDLE



MOUNTING

PLASTIC HOUSING - DROP-IN CUTOUT

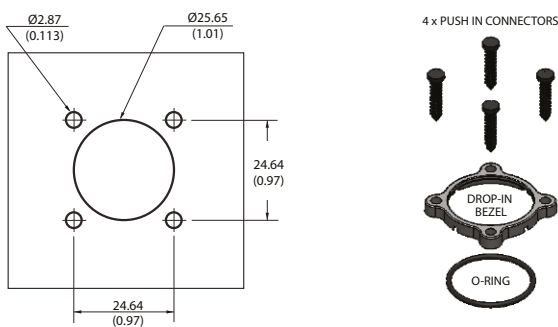

- The under panel depth for the Drop-in configuration is 16.02 mm (0.631 in).

PLASTIC HOUSING - REAR MOUNT OPTION CUTOUT

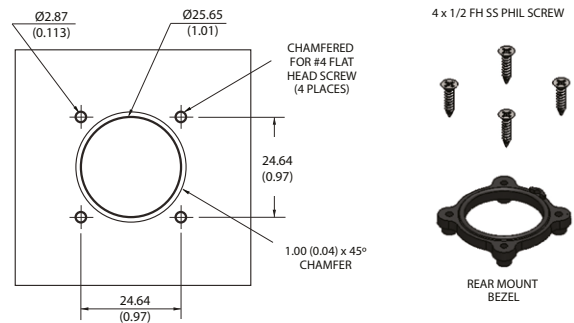

- The maximum panel thickness for the Rear Mount configuration is 2.032 mm (0.08 in).

- Mounting screws can be driven to a recommended torque of 4 lbf.

METAL THREADED HOUSING - DROP-IN CUTOUT

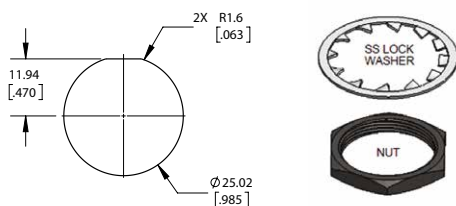

- The under panel depth for the Metal Threaded Housing configuration is 14.55 mm (0.573 in).
- Mounting nut can be tightened to a recommended torque of 10 lbf.

PLASTIC THREADED HOUSING - DROP-IN CUTOUT

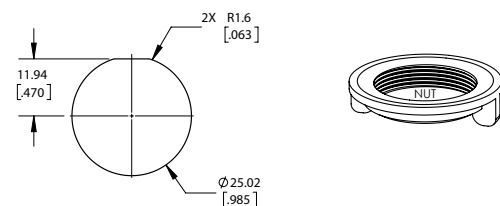

- The under panel depth for the Plastic Threaded Housing configuration is 14.55 mm (0.573 in).
- Mounting nut can be tightened to a recommended torque of 10 lbf.

TS series

Proportional miniature thumb controls • non-contacting Hall effect technology



BUILD YOUR PART NUMBER

<div style="border: 1px solid black; padding: 2px; width: 40px; margin: 0 auto;">TS</div> <p>SERIES</p>	<div style="border: 1px solid black; width: 40px; height: 20px; margin: 0 auto;"></div> <p>HANDLE¹</p>	<div style="border: 1px solid black; width: 40px; height: 20px; margin: 0 auto;"></div> <p>MOUNTING OPTIONS</p>	<div style="border: 1px solid black; width: 40px; height: 20px; margin: 0 auto;"></div> <p>TERMINATION²</p>	<div style="border: 1px solid black; width: 40px; height: 20px; margin: 0 auto;"></div> <p>LIMITER</p>																									
<table border="0"> <tr><td>0 None</td><td>6 Pushbutton¹⁻¹</td><td>D Conical, elastomer</td></tr> <tr><td>1 Castle</td><td>7 Mushroom¹⁻¹⁺¹⁻²</td><td>E Quadcave</td></tr> <tr><td>2 Winged Hat</td><td>8 Low Profile¹⁻¹⁺¹⁻²</td><td>F Puck</td></tr> <tr><td>3 Conical</td><td>A Handles 1, 2, 3</td><td>G Roller</td></tr> <tr><td>4 Finger Tip</td><td>B Castle, elastomer</td><td>H Castle, LED illumination</td></tr> <tr><td>5 Round Jog</td><td>C Winged Hat, elastomer</td><td></td></tr> </table>	0 None	6 Pushbutton ¹⁻¹	D Conical, elastomer	1 Castle	7 Mushroom ¹⁻¹⁺¹⁻²	E Quadcave	2 Winged Hat	8 Low Profile ¹⁻¹⁺¹⁻²	F Puck	3 Conical	A Handles 1, 2, 3	G Roller	4 Finger Tip	B Castle, elastomer	H Castle, LED illumination	5 Round Jog	C Winged Hat, elastomer		<table border="0"> <tr><td>1 22 AWG 25 cm PTFE²⁻¹</td><td>U Single axis </td></tr> <tr><td>2 28 AWG 25 cm PTFE²⁻²</td><td>S Square </td></tr> <tr><td>3 72" Overmold Cable with USB Male Type Connector</td><td>G Guided feel </td></tr> <tr><td>4 2.54 mm (0.100") Pitch TE Connector</td><td>P Plus </td></tr> <tr><td>5 2.54 mm (0.100") Pitch TE Connector with 10" Mating Harness</td><td></td></tr> </table>	1 22 AWG 25 cm PTFE ²⁻¹	U Single axis	2 28 AWG 25 cm PTFE ²⁻²	S Square	3 72" Overmold Cable with USB Male Type Connector	G Guided feel	4 2.54 mm (0.100") Pitch TE Connector	P Plus	5 2.54 mm (0.100") Pitch TE Connector with 10" Mating Harness	
0 None	6 Pushbutton ¹⁻¹	D Conical, elastomer																											
1 Castle	7 Mushroom ¹⁻¹⁺¹⁻²	E Quadcave																											
2 Winged Hat	8 Low Profile ¹⁻¹⁺¹⁻²	F Puck																											
3 Conical	A Handles 1, 2, 3	G Roller																											
4 Finger Tip	B Castle, elastomer	H Castle, LED illumination																											
5 Round Jog	C Winged Hat, elastomer																												
1 22 AWG 25 cm PTFE ²⁻¹	U Single axis																												
2 28 AWG 25 cm PTFE ²⁻²	S Square																												
3 72" Overmold Cable with USB Male Type Connector	G Guided feel																												
4 2.54 mm (0.100") Pitch TE Connector	P Plus																												
5 2.54 mm (0.100") Pitch TE Connector with 10" Mating Harness																													
<p>OUTPUT OPTIONS⁴</p> <table border="0"> <tr><td>00 0 V to 5 V</td><td>06 0.5 V to 4.5 V - Sensor 1 0.5 V to 4.5 V - Sensor 2</td><td>11 1 V to 4 V - Sensor 1 4 V to 1 V - Sensor 2</td></tr> <tr><td>01 0.25 V to 4.75 V</td><td>07 1 V to 4 V - Sensor 1 1 V to 4 V - Sensor 2</td><td>12 Customer specified</td></tr> <tr><td>02 0.5 V to 4.5 V</td><td>08 0 V to 5 V - Sensor 1 5 V to 0 V - Sensor 2</td><td>13 PWM³</td></tr> <tr><td>03 1 V to 4 V</td><td>09 0.5 V to 4.5 V - Sensor 1 4.5 V to 0.5 V - Sensor 2</td><td>14 USB (Game Controller)</td></tr> <tr><td>04 0 V to 5 V - Sensor 1 0 V to 5 V - Sensor 2</td><td>10 0.25 V to 4.75 V - Sensor 1 4.75 V to 0.25 V - Sensor 2</td><td>15 Joyball (Cursor emulation)</td></tr> <tr><td>05 0.25 V to 4.75 V - Sensor 1 0.25 V to 4.75 V - Sensor 2</td><td></td><td></td></tr> </table>		00 0 V to 5 V	06 0.5 V to 4.5 V - Sensor 1 0.5 V to 4.5 V - Sensor 2	11 1 V to 4 V - Sensor 1 4 V to 1 V - Sensor 2	01 0.25 V to 4.75 V	07 1 V to 4 V - Sensor 1 1 V to 4 V - Sensor 2	12 Customer specified	02 0.5 V to 4.5 V	08 0 V to 5 V - Sensor 1 5 V to 0 V - Sensor 2	13 PWM ³	03 1 V to 4 V	09 0.5 V to 4.5 V - Sensor 1 4.5 V to 0.5 V - Sensor 2	14 USB (Game Controller)	04 0 V to 5 V - Sensor 1 0 V to 5 V - Sensor 2	10 0.25 V to 4.75 V - Sensor 1 4.75 V to 0.25 V - Sensor 2	15 Joyball (Cursor emulation)	05 0.25 V to 4.75 V - Sensor 1 0.25 V to 4.75 V - Sensor 2			<p>LED CONTROL</p> <table border="0"> <tr><td>BLANK No illumination</td></tr> <tr><td>1 ON, driven by joystick supply voltage⁶</td></tr> <tr><td>2 User controlled⁷</td></tr> </table>		BLANK No illumination	1 ON, driven by joystick supply voltage ⁶	2 User controlled ⁷					
00 0 V to 5 V	06 0.5 V to 4.5 V - Sensor 1 0.5 V to 4.5 V - Sensor 2	11 1 V to 4 V - Sensor 1 4 V to 1 V - Sensor 2																											
01 0.25 V to 4.75 V	07 1 V to 4 V - Sensor 1 1 V to 4 V - Sensor 2	12 Customer specified																											
02 0.5 V to 4.5 V	08 0 V to 5 V - Sensor 1 5 V to 0 V - Sensor 2	13 PWM ³																											
03 1 V to 4 V	09 0.5 V to 4.5 V - Sensor 1 4.5 V to 0.5 V - Sensor 2	14 USB (Game Controller)																											
04 0 V to 5 V - Sensor 1 0 V to 5 V - Sensor 2	10 0.25 V to 4.75 V - Sensor 1 4.75 V to 0.25 V - Sensor 2	15 Joyball (Cursor emulation)																											
05 0.25 V to 4.75 V - Sensor 1 0.25 V to 4.75 V - Sensor 2																													
BLANK No illumination																													
1 ON, driven by joystick supply voltage ⁶																													
2 User controlled ⁷																													
<p>POWER SUPPLY OPTIONS</p> <table border="0"> <tr><td>A Single</td></tr> <tr><td>B Independent⁵</td></tr> </table>		A Single	B Independent ⁵	<p>LED COLOR</p> <table border="0"> <tr><td>BLANK No illumination</td></tr> <tr><td>BB Blue</td></tr> <tr><td>RR Red</td></tr> </table>		BLANK No illumination	BB Blue	RR Red																					
A Single																													
B Independent ⁵																													
BLANK No illumination																													
BB Blue																													
RR Red																													

¹⁻¹ Pushbutton (6), Mushroom (7) and Low profile (8) handle not available with P mounting option (threaded housing, plastic)

¹⁻² Mushroom (7) and Low profile (8) handle not available with T mounting option (threaded housing, metal)

²⁻¹ Wires are thick, robust, and best suited for stand alone applications.

²⁻² Wires are thin and best suited for tightly constrained wire routing.

³ Contact factory for PWM configuration.

⁴ Output voltage is ratiometric to supply voltage.

⁵ Only available on dual output. Not available with Handle 6 (Pushbutton). Not available with termination options 4 or 5.

⁶ LED control is driven by joystick supply voltage. Illumination is constantly on

⁷ LED requires independent 5V supply. Illumination is user controlled.

TS series

Proportional miniature thumb controls • non-contacting Hall effect technology

PLASTIC HOUSING



METAL THREADED HOUSING



PLASTIC THREADED HOUSING

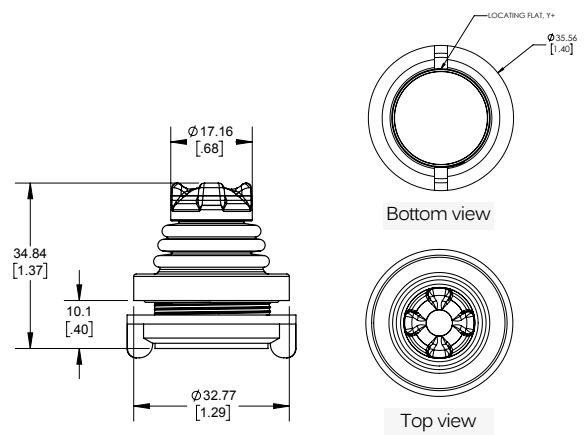
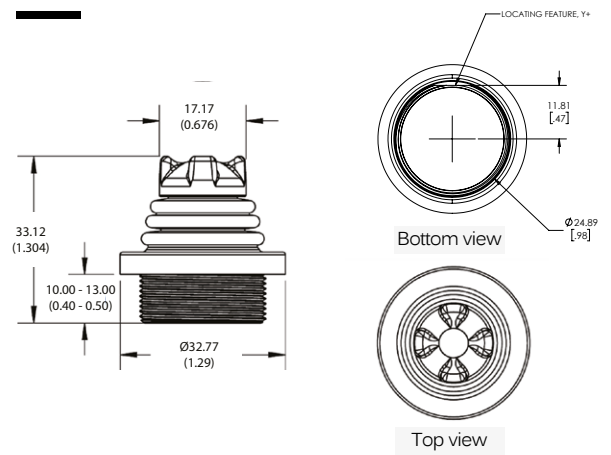
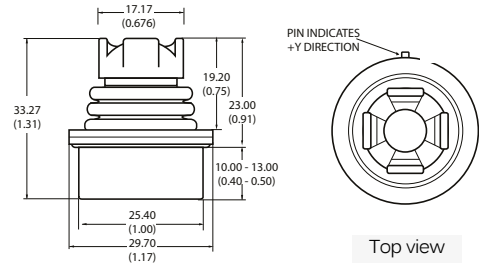

TS series

Proportional miniature thumb controls •
non-contacting Hall effect technology



HANDLE OPTIONS

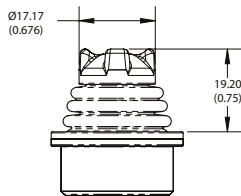

1 Castle
B Castle (elastomer)

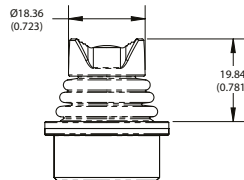

2 Winged hat
C Winged hat (elastomer)

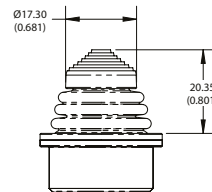

3 Conical
D Conical (elastomer)

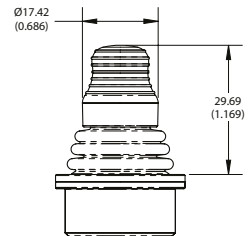

4 Fingertip

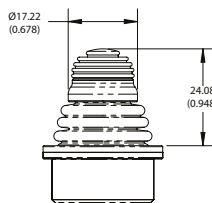

5 Round jog

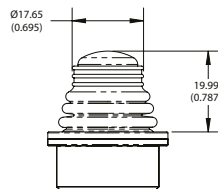

6 Pushbutton

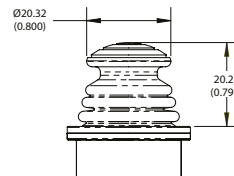

7 Mushroom

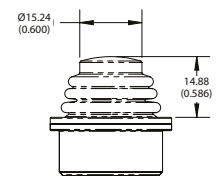

8 Low profile

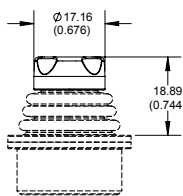

E Quadcave

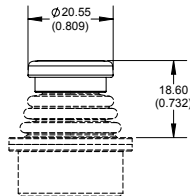

F Puck

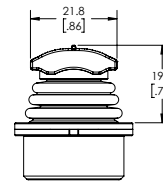

G Roller

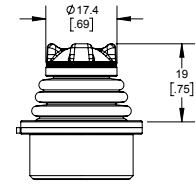

H Castle, LED illumination



USB OPTIONS

USB : GAME CONTROLLER

Featuring USB 2.0 HID compliant interface. APEM's USB joysticks are recognized as standard HID "game controller" devices. Adhering to the HID specification, APEM's USB joysticks are plug-and-play with most versions of Windows. Joystick button and axis assignments are dependent upon the controlled application.

- Features:
 - USB 2.0 HID compliant "game controller" device
 - Easy to install and operate
 - Functions determined by controlled application
- Supplied wiring: USB Male Type A Connector with 72" overmolded cable

USB: JOYBALL (CURSOR EMULATION)

The cursor emulation option converts a multi-axis joystick into a mouse or cursor control device

- Applications: The cursor emulation option is ideal for vehicle applications subjected to dirt and high vibration which makes operating a traditional cursor control device difficult. The Cursor Emulation option is widely used in shipboard and military applications.
- Features:
 - HID compliant "pointing device"
 - Plug-and-play with USB option
- Supplied wiring: USB Male Type A Connector with overmolded cable

Proportional miniature thumb controls • non-contacting Hall effect technology



VOLTAGE OUTPUT OPTIONS ¹

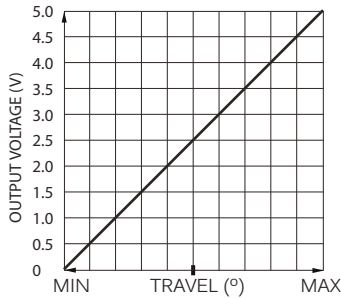

Option 00

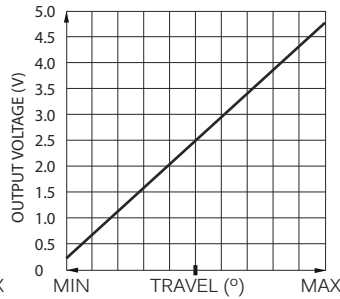

Option 01

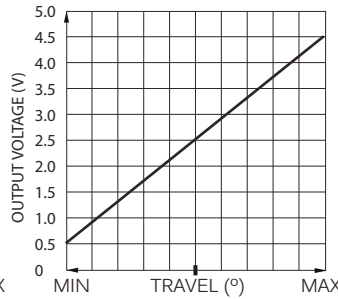

Option 02

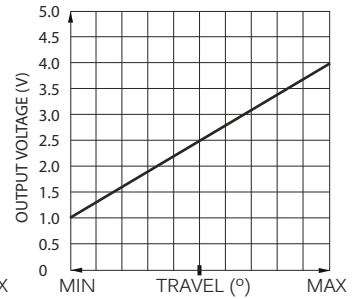

Option 03

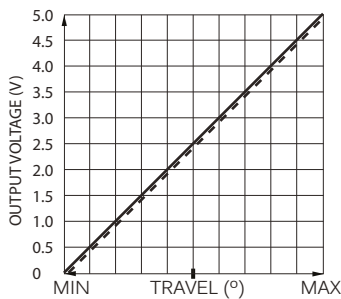

Option 04

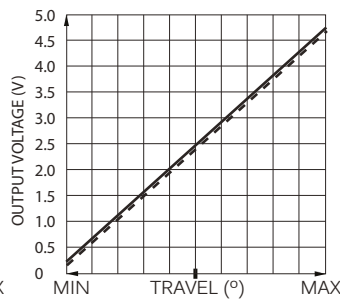

Option 05

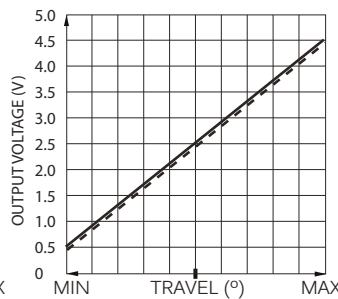

Option 06

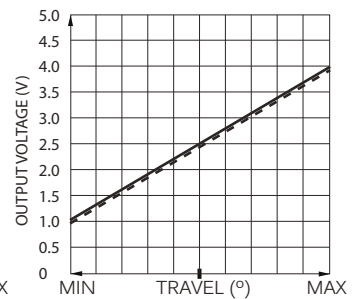

Option 07

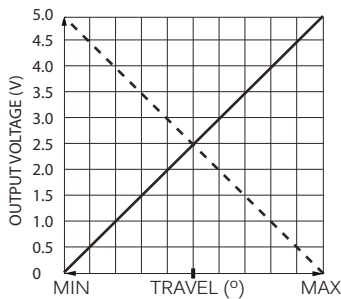

Option 08

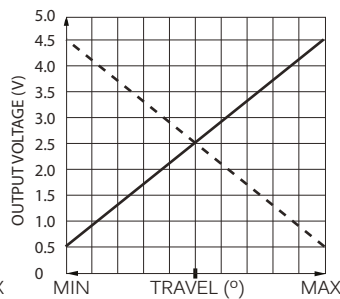

Option 09

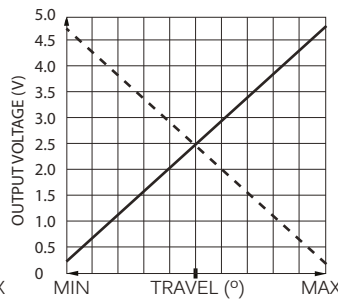

Option 10

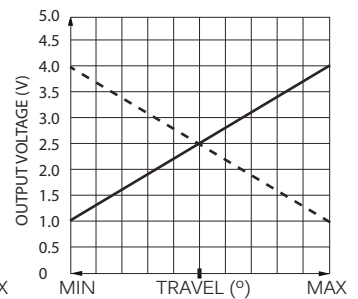

Option 11

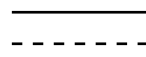

Sensor 1

Sensor 2



CONNECTOR TERMINATION OPTION

PINOUT SPECIFICATION		
	TE 3-647166-5	TE 3-647166-7
PIN 1	Y (alpha)	Pushbutton / LED
PIN 2	5 VDC ¹	GND / Pushbutton common / LED common
PIN 3	X (alpha)	X (alpha)
PIN 4	GND / Pushbutton common / LED common	Y (beta)
PIN 5	Pushbutton / LED	Y (alpha)
PIN 6	-	5 VDC
PIN 7	-	X (beta)

- Single output configurations feature a five position TE 3-647166-5 connector.
- Dual output configurations feature a seven position TE 3-647166-7 connector.
- A mating harness is not included, but may be specified for single output configurations at the time of order for an additional charge.
- The five function harness is part number 505-499.
- The seven function harness is part number 505-500.

¹ Voltage outputs are ratiometric to supply voltage

X-ON Electronics

Largest Supplier of Electrical and Electronic Components

Click to view similar products for [Joysticks](#) category:

Click to view products by [Apem](#) manufacturer:

Other Similar products are found below :

[M11L0A1](#) [C1000C1P](#) [S10L0A1M](#) [G3-A1AM151NNNN](#) [TH500P00D4](#) [C1000C1PMJ0](#) [S10L061J](#) [60C22-M7-4-020S](#) [67A-DF-3C-060C](#)
[60A00-8-050C](#) [60A00-4-050C](#) [60C22-M7-4-040S](#) [G3-0425](#) [S30L081F50](#) [3440SAT6476](#) [60A18-4-090C](#) [S30L081J](#) [M11L001C](#) [M11L0X1P](#)
[USBM31Q081RMJ4S](#) [USBC20O051JMJS](#) [TW08BLK12](#) [S30L0M1CSJBLK](#) [HF11R11](#) [HG-44MIS000-2654](#) [HG-44MIS000-U-2655](#)
[4P182F1E55475](#) [TS4A1S00A](#) [BD140D01GR0000](#) [BD150SD4BL1200](#) [3140SAL6475](#) [TW01BLK11](#) [TW01GRY1](#) [ZD4PA203](#)
[HF44S10UMJ0](#) [TS3N2S00A](#) [TS1R1U00A](#) [TS1R1S09A](#) [TS1D2S00A](#) [HFX45S02](#) [HFX10S00](#) [HF11P11](#) [4R28-2S1E-55-00](#)
[BD150A01RE0000](#) [BD150D02BK1200](#) [ZD4PA24](#) [ZD4PA22](#) [ZD4PA12](#) [ZD4PA14](#) [J1-00105-S-G](#)