

# TS series

Proportional miniature thumb controls •  
non-contacting Hall effect technology



## DISTINCTIVE FEATURES

- One or two axis
- Analog, PWM or USB outputs
- IP67 Above panel sealing mounting
- Rear or drop-in mounting
- Pushbutton option



## ENVIRONMENTAL SPECIFICATIONS

- Operating Temperature: -40 °C to +85 °C (-40 °F to +185 °F)
- Storage Temperature: -40 °C to +85 °C (-40 °F to +185 °F)
- Above Panel Sealing: IP67, IP69K<sup>1</sup> (subject to mounting style & final specifications)
- EMC Immunity Level: EN61000-4-3
- EMC Emissions Level: EN61000-6-3:2001
- ESD: EN61000-4-2



## SENSOR SPECIFICATIONS

- Technology: Hall effect sensors, single or dual
- Supply Voltage Range: 5.00 V ± 0.01 VDC
- Supply Current: 11 mA max
- Ratiometric Output Options: See options
- Reverse Polarity max: -10 V
- Transient overvoltage max: 16 V
- Start-up time: 15 ms max
- Output Impedance: 2Ω
- Return to Center Voltage Tolerance: ± 200 mV initial



U.S. Patent #D816,169 S  
U.S. Patent #D732,047 S  
U.S. Patent #D816,169 S  
U.S. Patent #D734,138 S

The company reserves the right to change specifications without notice.

# TS series

Proportional miniature thumb controls • non-contacting Hall effect technology



## MECHANICAL SPECIFICATIONS

- Operating Force: 3.1 N ± 0.5 N (0.70 lbf ± 0.11 lbf)<sup>2</sup>
- Maximum Vertical Load: 200 N (45 lbf)<sup>2</sup>
- Maximum Horizontal Load: 150 N (33.7 lbf)<sup>2</sup>
- Mechanical Angle of Movement: 50° X & Y axis (subject to limiter plate)
- Expected Life: 1 million cycles
- Mass/Weight: 18.25 g ± 5.0 g (0.64 oz ± 0.18 oz)
- Lever Action (centering): Spring

<sup>1</sup> All options are IP68 and IP69K rated, however drop-in mounting does not prevent panel ingress.

<sup>2</sup> Force applied to the top of the castle cap.



## MATERIALS

- Body: Glass filled nylon
- Threaded Housing: Black oxide plated brass
- Boot: Silicone
- Handles:
  - 1, 2, 3, E, F, G - Glass filled nylon
  - 4, 5, 6, 7, 8 - Silicone
  - B, C, D - Thermoplastic elastomer
  - H - Polycarbonate

APEM products may be recycled at end-of-life for the re-claiming of valuable metal components.



## CONNECTIONS

WIRING SPECIFICATION  
(Termination options 1 & 2)

Black	Ground & button common, or LED common
Red	Power (5 V) <sup>1</sup>
Blue	X axis output (alpha)
Yellow	Y axis output (alpha)
Orange	Pushbutton switch (option 6 handle) or LED supply (option H handle) <sup>2 2</sup>
Blue/White Stripe	X axis output (beta)
Yellow/Black Stripe	Y axis output (beta)
Red/White Stripe	Power (5 V) (beta)
Black/White Stripe	Ground (beta)

<sup>1</sup> Hall sensor and LED supply (LED control option 1)

<sup>2</sup> User controllable (LED control option 2)



## PUSHBUTTON SWITCH SPECIFICATIONS (OPTION 6 HANDLE)

- Electrical Life: 100,000 cycles
- Rating: 50 mA, 12 VDC.
- Terminal: Brass with silver plating
- Contact Resistance: 100 mΩ max
- Insulation Resistance: 100 MΩ min. 500 VDC
- Dielectric Strength: 250 VAC /1 minute
- Contact Arrangement: 1 pole 1 throw
- Stop Strength: Max 3 kgf vertical static load for 15 seconds
- Operating Temperature: -25 °C to +70 °C (-4 °F to +158 °F)
- Storage Temperature: -30 °C to +85 °C (-22 °F to +158 °F)
- Vibration Resistance: MIL-STD-202F METHOD 201A
- Shock Resistance: MIL-STD-202F METHOD 213B



## LED SPECIFICATIONS (OPTION H HANDLE)

LED CONTROL	OPERATING VOLTAGE	OPERATING CURRENT
1 – ON, driven by joystick supply voltage	-	6 mA
2 – User controlled	5 V	6 mA

Proportional miniature thumb controls • non-contacting Hall effect technology



## NEW OPTIONS AVAILABLE

PLASTIC THREADED HOUSING



LED ILLUMINATION OPTION H HANDLE



## MOUNTING

PLASTIC HOUSING - DROP-IN CUTOUT

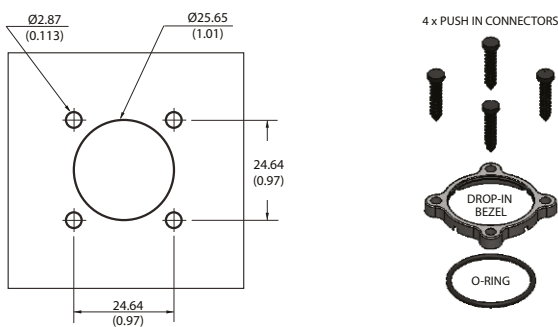

- The under panel depth for the Drop-in configuration is 16.02 mm (0.631 in).

PLASTIC HOUSING - REAR MOUNT OPTION CUTOUT

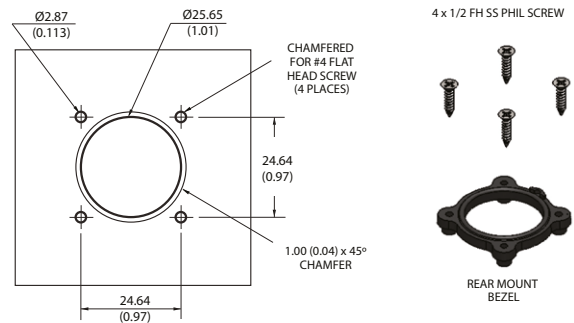

- The maximum panel thickness for the Rear Mount configuration is 2.032 mm (0.08 in).

- Mounting screws can be driven to a recommended torque of 4 lbf.

METAL THREADED HOUSING - DROP-IN CUTOUT

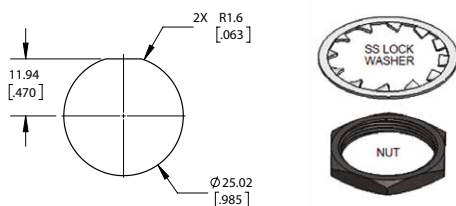

- The under panel depth for the Metal Threaded Housing configuration is 14.55 mm (0.573 in).
- Mounting nut can be tightened to a recommended torque of 10 lbf.

PLASTIC THREADED HOUSING - DROP-IN CUTOUT

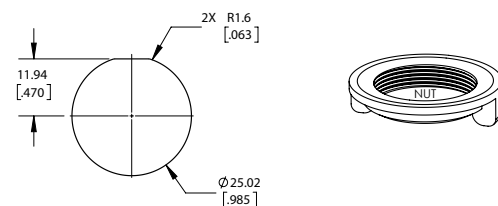

- The under panel depth for the Plastic Threaded Housing configuration is 14.55 mm (0.573 in).
- Mounting nut can be tightened to a recommended torque of 10 lbf.

# TS series

Proportional miniature thumb controls • non-contacting Hall effect technology



## BUILD YOUR PART NUMBER

SERIES	HANDLE <sup>1</sup>	MOUNTING OPTIONS	TERMINATION <sup>2</sup>	LIMITER																																																		
TS		<table border="1"> <tr><td>N</td><td>None</td></tr> <tr><td>D</td><td>Drop-in</td></tr> <tr><td>R</td><td>Rear mount</td></tr> <tr><td>A</td><td>Drop-in and Rear Mount</td></tr> <tr><td>T</td><td>Threaded housing, Metal</td></tr> <tr><td>P</td><td>Threaded housing, Plastic</td></tr> </table>	N	None	D	Drop-in	R	Rear mount	A	Drop-in and Rear Mount	T	Threaded housing, Metal	P	Threaded housing, Plastic	<table border="1"> <tr><td>1</td><td>22 AWG 25 cm PTFE<sup>2,1</sup></td></tr> <tr><td>2</td><td>28 AWG 25 cm PTFE<sup>2,2</sup></td></tr> <tr><td>3</td><td>72" Overmold Cable with USB Male Type Connector</td></tr> <tr><td>4</td><td>2.54 mm (0.100") Pitch TE Connector</td></tr> <tr><td>5</td><td>2.54 mm (0.100") Pitch TE Connector with 10" Mating Harness</td></tr> </table>	1	22 AWG 25 cm PTFE <sup>2,1</sup>	2	28 AWG 25 cm PTFE <sup>2,2</sup>	3	72" Overmold Cable with USB Male Type Connector	4	2.54 mm (0.100") Pitch TE Connector	5	2.54 mm (0.100") Pitch TE Connector with 10" Mating Harness	<table border="1"> <tr><td>U</td><td>Single axis</td><td></td></tr> <tr><td>S</td><td>Square</td><td></td></tr> <tr><td>G</td><td>Guided feel</td><td></td></tr> <tr><td>P</td><td>Plus</td><td></td></tr> </table>	U	Single axis		S	Square		G	Guided feel		P	Plus																	
N	None																																																					
D	Drop-in																																																					
R	Rear mount																																																					
A	Drop-in and Rear Mount																																																					
T	Threaded housing, Metal																																																					
P	Threaded housing, Plastic																																																					
1	22 AWG 25 cm PTFE <sup>2,1</sup>																																																					
2	28 AWG 25 cm PTFE <sup>2,2</sup>																																																					
3	72" Overmold Cable with USB Male Type Connector																																																					
4	2.54 mm (0.100") Pitch TE Connector																																																					
5	2.54 mm (0.100") Pitch TE Connector with 10" Mating Harness																																																					
U	Single axis																																																					
S	Square																																																					
G	Guided feel																																																					
P	Plus																																																					
	<table border="1"> <tr><td>0</td><td>None</td></tr> <tr><td>1</td><td>Castle</td></tr> <tr><td>2</td><td>Winged Hat</td></tr> <tr><td>3</td><td>Conical</td></tr> <tr><td>4</td><td>Finger Tip</td></tr> <tr><td>5</td><td>Round Jog</td></tr> <tr><td>6</td><td>Pushbutton<sup>1</sup></td></tr> <tr><td>7</td><td>Mushroom<sup>1</sup></td></tr> <tr><td>8</td><td>Low Profile<sup>1</sup></td></tr> <tr><td>A</td><td>Handles 1, 2, 3</td></tr> <tr><td>B</td><td>Castle, elastomer</td></tr> <tr><td>C</td><td>Winged Hat, elastomer</td></tr> <tr><td>D</td><td>Conical, elastomer</td></tr> <tr><td>E</td><td>Quadcave</td></tr> <tr><td>F</td><td>Puck</td></tr> <tr><td>G</td><td>Roller</td></tr> <tr><td>H</td><td>Castle, LED illumination</td></tr> </table>	0	None	1	Castle	2	Winged Hat	3	Conical	4	Finger Tip	5	Round Jog	6	Pushbutton <sup>1</sup>	7	Mushroom <sup>1</sup>	8	Low Profile <sup>1</sup>	A	Handles 1, 2, 3	B	Castle, elastomer	C	Winged Hat, elastomer	D	Conical, elastomer	E	Quadcave	F	Puck	G	Roller	H	Castle, LED illumination																			
0	None																																																					
1	Castle																																																					
2	Winged Hat																																																					
3	Conical																																																					
4	Finger Tip																																																					
5	Round Jog																																																					
6	Pushbutton <sup>1</sup>																																																					
7	Mushroom <sup>1</sup>																																																					
8	Low Profile <sup>1</sup>																																																					
A	Handles 1, 2, 3																																																					
B	Castle, elastomer																																																					
C	Winged Hat, elastomer																																																					
D	Conical, elastomer																																																					
E	Quadcave																																																					
F	Puck																																																					
G	Roller																																																					
H	Castle, LED illumination																																																					
		<table border="1"> <tr><td>00</td><td>0 V to 5 V</td></tr> <tr><td>01</td><td>0.25 V to 4.75 V</td></tr> <tr><td>02</td><td>0.5 V to 4.5 V</td></tr> <tr><td>03</td><td>1 V to 4 V</td></tr> <tr><td>04</td><td>0 V to 5 V - Sensor 1 0 V to 5 V - Sensor 2</td></tr> <tr><td>05</td><td>0.25 V to 4.75 V - Sensor 1 0.25 V to 4.75 V - Sensor 2</td></tr> <tr><td>06</td><td>0.5 V to 4.5 V - Sensor 1 0.5 V to 4.5 V - Sensor 2</td></tr> <tr><td>07</td><td>1 V to 4 V - Sensor 1 1 V to 4 V - Sensor 2</td></tr> <tr><td>08</td><td>0 V to 5 V - Sensor 1 5 V to 0 V - Sensor 2</td></tr> <tr><td>09</td><td>0.5 V to 4.5 V - Sensor 1 4.5 V to 0.5 V - Sensor 2</td></tr> <tr><td>10</td><td>0.25 V to 4.75 V - Sensor 1 4.75 V to 0.25 V - Sensor 2</td></tr> </table>	00	0 V to 5 V	01	0.25 V to 4.75 V	02	0.5 V to 4.5 V	03	1 V to 4 V	04	0 V to 5 V - Sensor 1 0 V to 5 V - Sensor 2	05	0.25 V to 4.75 V - Sensor 1 0.25 V to 4.75 V - Sensor 2	06	0.5 V to 4.5 V - Sensor 1 0.5 V to 4.5 V - Sensor 2	07	1 V to 4 V - Sensor 1 1 V to 4 V - Sensor 2	08	0 V to 5 V - Sensor 1 5 V to 0 V - Sensor 2	09	0.5 V to 4.5 V - Sensor 1 4.5 V to 0.5 V - Sensor 2	10	0.25 V to 4.75 V - Sensor 1 4.75 V to 0.25 V - Sensor 2	<table border="1"> <tr><td>11</td><td>1 V to 4 V - Sensor 1 4 V to 1 V - Sensor 2</td></tr> <tr><td>12</td><td>Customer specified</td></tr> <tr><td>13</td><td>PWM<sup>3</sup></td></tr> <tr><td>14</td><td>USB (Game Controller)</td></tr> <tr><td>15</td><td>Joyball (Cursor emulation)</td></tr> </table>	11	1 V to 4 V - Sensor 1 4 V to 1 V - Sensor 2	12	Customer specified	13	PWM <sup>3</sup>	14	USB (Game Controller)	15	Joyball (Cursor emulation)	<table border="1"> <tr><td>BLANK</td><td>No illumination</td></tr> <tr><td>1</td><td>ON, driven by joystick supply voltage<sup>6</sup></td></tr> <tr><td>2</td><td>User controlled<sup>7</sup></td></tr> </table>	BLANK	No illumination	1	ON, driven by joystick supply voltage <sup>6</sup>	2	User controlled <sup>7</sup>	<table border="1"> <tr><td>A</td><td>Single</td></tr> <tr><td>B</td><td>Independent<sup>5</sup></td></tr> </table>	A	Single	B	Independent <sup>5</sup>	<table border="1"> <tr><td>BLANK</td><td>No illumination</td></tr> <tr><td>BB</td><td>Blue</td></tr> <tr><td>RR</td><td>Red</td></tr> </table>	BLANK	No illumination	BB	Blue	RR	Red
00	0 V to 5 V																																																					
01	0.25 V to 4.75 V																																																					
02	0.5 V to 4.5 V																																																					
03	1 V to 4 V																																																					
04	0 V to 5 V - Sensor 1 0 V to 5 V - Sensor 2																																																					
05	0.25 V to 4.75 V - Sensor 1 0.25 V to 4.75 V - Sensor 2																																																					
06	0.5 V to 4.5 V - Sensor 1 0.5 V to 4.5 V - Sensor 2																																																					
07	1 V to 4 V - Sensor 1 1 V to 4 V - Sensor 2																																																					
08	0 V to 5 V - Sensor 1 5 V to 0 V - Sensor 2																																																					
09	0.5 V to 4.5 V - Sensor 1 4.5 V to 0.5 V - Sensor 2																																																					
10	0.25 V to 4.75 V - Sensor 1 4.75 V to 0.25 V - Sensor 2																																																					
11	1 V to 4 V - Sensor 1 4 V to 1 V - Sensor 2																																																					
12	Customer specified																																																					
13	PWM <sup>3</sup>																																																					
14	USB (Game Controller)																																																					
15	Joyball (Cursor emulation)																																																					
BLANK	No illumination																																																					
1	ON, driven by joystick supply voltage <sup>6</sup>																																																					
2	User controlled <sup>7</sup>																																																					
A	Single																																																					
B	Independent <sup>5</sup>																																																					
BLANK	No illumination																																																					
BB	Blue																																																					
RR	Red																																																					

<sup>1</sup> Pushbutton, Mushroom and Low profile handle not available with P (threaded housing, plastic),

<sup>2,1</sup> Wires are thick, robust, and best suited for stand alone applications.

<sup>2,2</sup> Wires are thin and best suited for tightly constrained wire routing.

<sup>3</sup> Contact factory for PWM configuration.

<sup>4</sup> Output voltage is ratiometric to supply voltage.

<sup>5</sup> Only available on dual output. Not available with Handle 6 (Pushbutton). Not available with termination options 4 or 5.

<sup>6</sup> LED control is driven by joystick supply voltage. Illumination is constantly on

<sup>7</sup> LED requires independent 5V supply. Illumination is user controlled.

# TS series

Proportional miniature thumb controls • non-contacting Hall effect technology

## PLASTIC HOUSING



## METAL THREADED HOUSING



## PLASTIC THREADED HOUSING

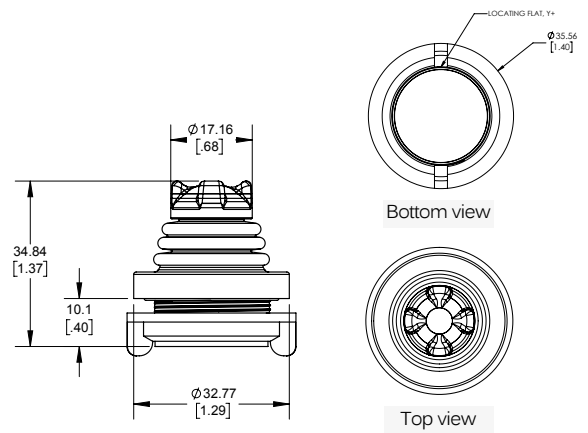
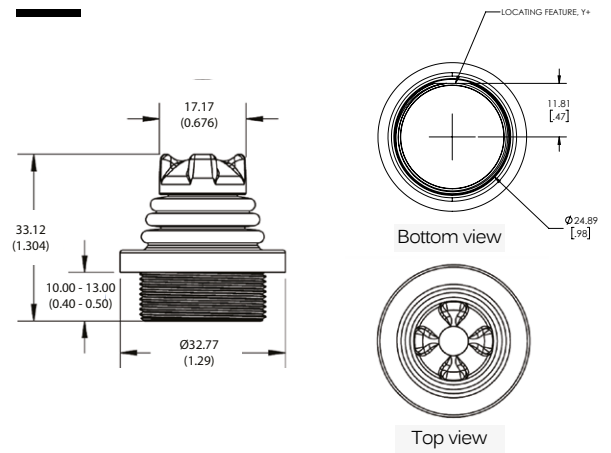
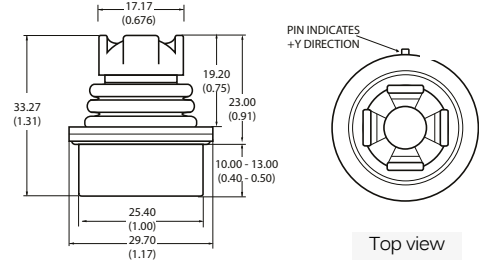

# TS series

Proportional miniature thumb controls •  
non-contacting Hall effect technology



## HANDLE OPTIONS

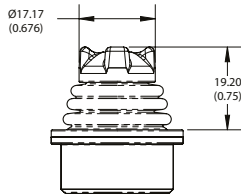

**1** Castle  
**B** Castle (elastomer)

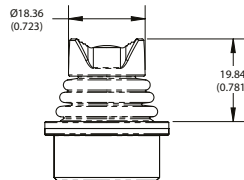

**2** Winged hat  
**C** Winged hat (elastomer)

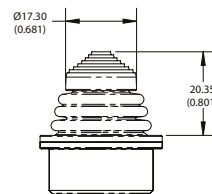

**3** Conical  
**D** Conical (elastomer)

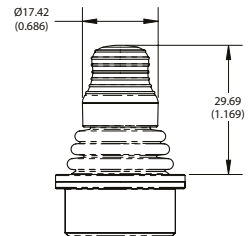

**4** Fingertip

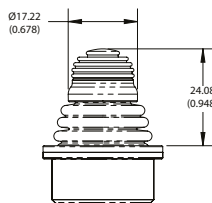

**5** Round jog

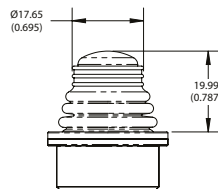

**6** Pushbutton

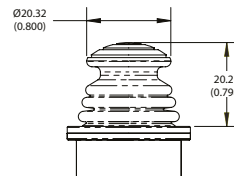

**7** Mushroom

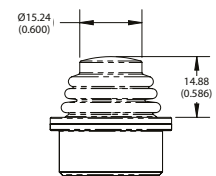

**8** Low profile

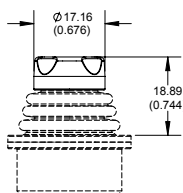

**E** Quadcave

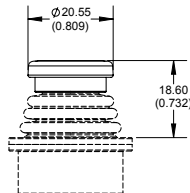

**F** Puck

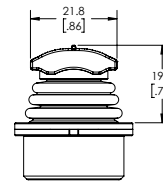

**G** Roller

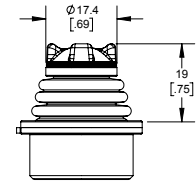

**H** Castle, LED illumination



## USB OPTIONS

### USB : GAME CONTROLLER

Featuring USB 2.0 HID compliant interface. APEM's USB joysticks are recognized as standard HID "game controller" devices. Adhering to the HID specification, APEM's USB joysticks are plug-and-play with most versions of Windows. Joystick button and axis assignments are dependent upon the controlled application.

- Features:
  - USB 2.0 HID compliant "game controller" device
  - Easy to install and operate
  - Functions determined by controlled application
- Supplied wiring: USB Male Type A Connector with 72" overmolded cable

### USB: JOYBALL (CURSOR EMULATION)

The cursor emulation option converts a multi-axis joystick into a mouse or cursor control device

- Applications: The cursor emulation option is ideal for vehicle applications subjected to dirt and high vibration which makes operating a traditional cursor control device difficult. The Cursor Emulation option is widely used in shipboard and military applications.
- Features:
  - HID compliant "pointing device"
  - Plug-and-play with USB option
- Supplied wiring: USB Male Type A Connector with overmolded cable

Proportional miniature thumb controls • non-contacting Hall effect technology



## VOLTAGE OUTPUT OPTIONS <sup>1</sup>

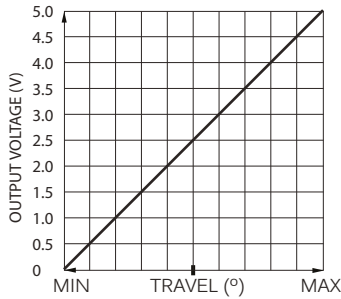

Option 00

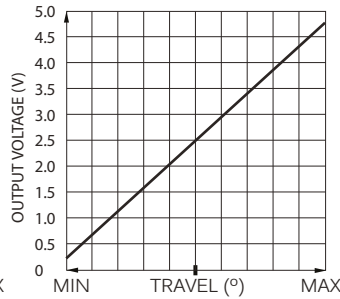

Option 01

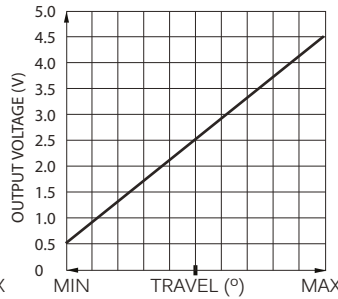

Option 02

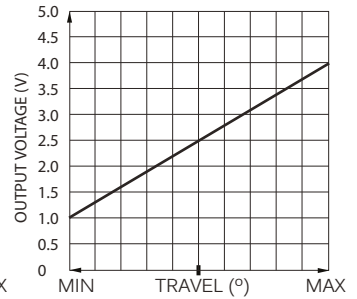

Option 03

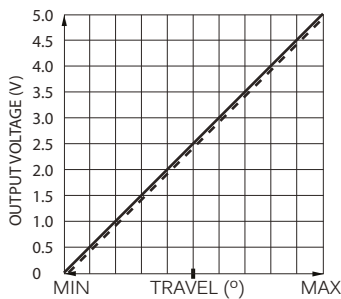

Option 04

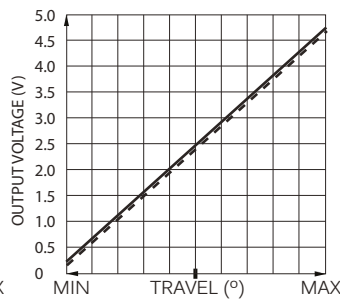

Option 05

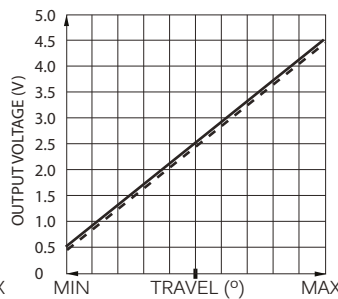

Option 06

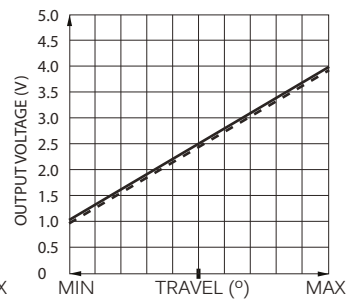

Option 07

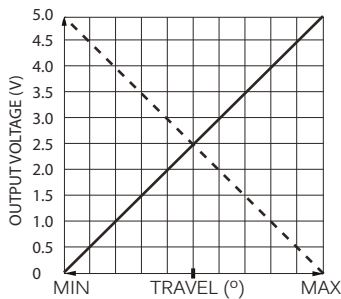

Option 08

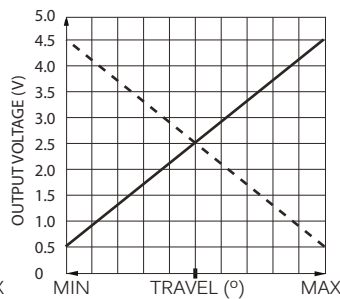

Option 09

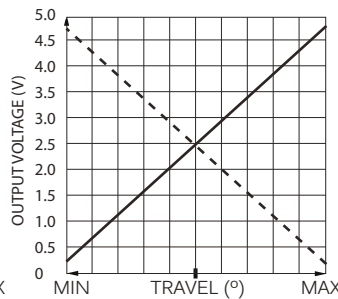

Option 10

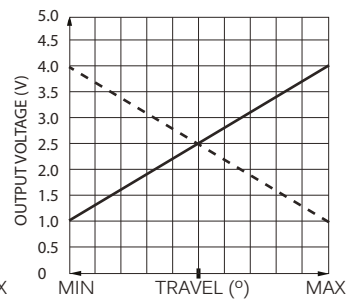

Option 11

— Sensor 1  
- - - Sensor 2



## CONNECTOR TERMINATION OPTION

PINOUT SPECIFICATION		
	TE 3-647166-5	TE 3-647166-7
PIN 1	Y (alpha)	Pushbutton / LED
PIN 2	5 VDC <sup>1</sup>	GND / Pushbutton common / LED common
PIN 3	X (alpha)	X (alpha)
PIN 4	GND / Pushbutton common / LED common	Y (beta)
PIN 5	Pushbutton / LED	Y (alpha)
PIN 6	-	5 VDC
PIN 7	-	X (beta)

- Single output configurations feature a five position TE 3-647166-5 connector.
- Dual output configurations feature a seven position TE 3-647166-7 connector.
- A mating harness is not included, but may be specified for single output configurations at the time of order for an additional charge.
- The five function harness is part number 505-499.
- The seven function harness is part number 505-500.

<sup>1</sup> Voltage outputs are ratiometric to supply voltage

## X-ON Electronics

Largest Supplier of Electrical and Electronic Components

*Click to view similar products for [Input Devices](#) category:*

*Click to view products by [Apem](#) manufacturer:*

Other Similar products are found below :

[80260-00](#) [81485-28](#) [81521-08](#) [FKB4720-103](#) [84250-26](#) [84980-04](#) [84S-AC1-000](#) [JD-0700EU-2](#) [JM-0800-2](#) [JW-T0100](#) [89498-13](#) [89758-05](#)  
[89886-26](#) [89941-00](#) [G80-3000LSCEU-2](#) [MJ0FGGRY](#) [JM-0800-0](#) [84S-BB1-004](#) [81601-26](#) [UL21KMZQ](#) [G8011900LPMUS0](#) [G84-](#)  
[4700LUCUS-0](#) [81485-26](#) [84105-13](#) [V400-W24 5M](#) [V400-W23 5M](#) [G84-5200LCMEU-2](#) [DT2257X20V00GRY](#) [V400-W23P 5M](#)  
[VW3A8151R20U](#) [V400-W24 15M](#) [LT1332D](#) [V400-W24 10M](#) [V400-W24P 15M](#) [V400-WM0 1M](#) [V400-W24P 10M](#) [V400-W23P 10M](#)  
[TCS-1492OP](#) [V400-W23 3M](#) [LT1372D](#) [LP1007EXXH00R](#) [DT2253X20V00BLK](#) [100133BX](#) [EZ08-230013](#) [81248-04](#) [89887-26](#) [90215-00](#)  
[HB110C3NWBNA](#) [9700001201](#) [80260-08](#)