

Hardware

For miniature and industrial switches

Standard hardware is automatically supplied with the switches
 Non-standard hardware is presented below



Hardware supplied with sealing options :

- K version : 2 hex nuts + sealing washer
- X408 option : 1 hex nut + 1 O-ring

STANDARD HARDWARE FOR SWITCHES Ø 6 (.236) - ALL SERIES

HEX NUT

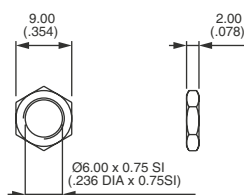

Nickel plated U208
 Black U726

LOCKING RING

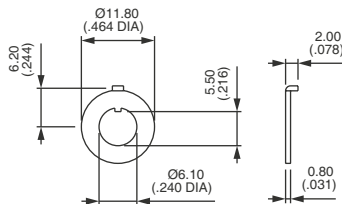

Nickel plated U198
 Black U728

LOCKWASHER

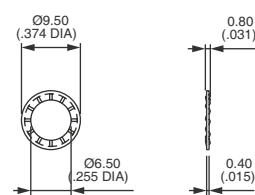

Stainless steel U215

NON-STANDARD HARDWARE FOR SWITCHES Ø 6 (.236) - 5000 SERIES

KNURLED NUT

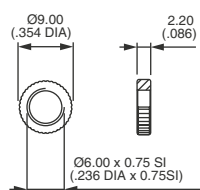

Chrome plated U826

SPECIAL NUT 12 (.472) ACROSS FLATS

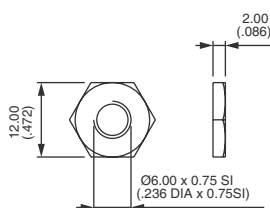

Chrome plated U1916

KNURLED CAP NUTS

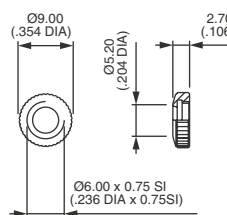

Chrome plated U461
 Black U502

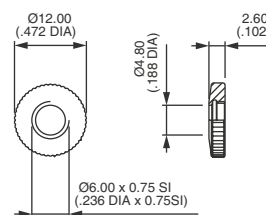

Chrome plated U232

STANDARD HARDWARE FOR SWITCHES Ø 6.35 (1/4) - ALL SERIES

HEX NUT

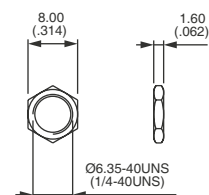

Nickel plated U76
 Black U94

LOCKING RING

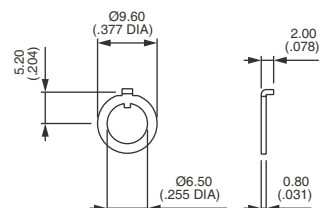

Nickel plated U78
 Black U93

LOCKWASHER

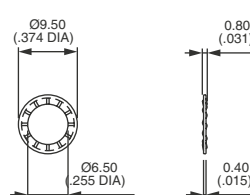

Stainless steel U215

SERIES	HARDWARE SUPPLIED (UNSEALED TYPES)		
	HEX NUT	LOCKING RING	LOCKWASHER
SF	2	1	1
11000	2	1	1
13000	2	1	1
18000-8000-SP	2	1	1
21000N	2	-	-
5000	2	1	1
9400-9600	2	-	1

The company reserves the right to change specifications without notice.

Hardware

For miniature and industrial switches

NON-STANDARD HARDWARE FOR SWITCHES Ø 6.35 (1/4) - ALL SERIES

KNURLED NUT

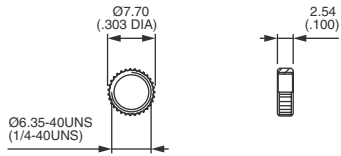

Nickel plated **U369**

KNURLED NUT

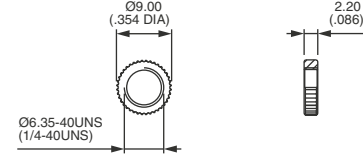

Nickel plated **U229**
Black **U230**

KNURLED NUT

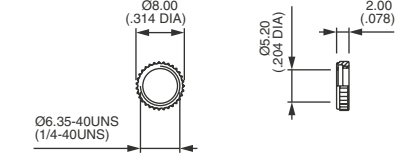

Chrome plated **U501**

KNURLED CAP NUT

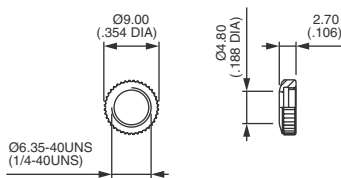

Chrome plated **U216 ***
Black **U218**

KNURLED CAP NUT

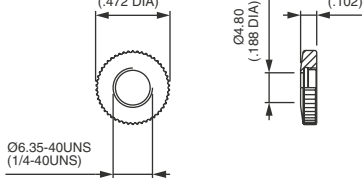

Chrome plated **U268 ***
Black **U725**

DRESS NUT

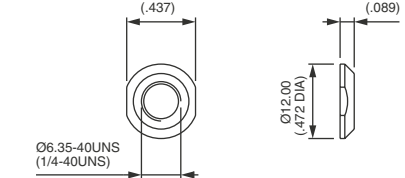

Nickel plated **U443**
Black **U848**

* U216 and U268 : consult factory for mounting on 11000 three and four pole, and 5000 locking lever models.

OTHER HARDWARE FOR SWITCHES Ø 6.35 (1/4) - ALL SERIES

CONIC CAP NUT

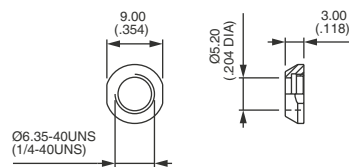

Nickel plated **U500**

CONIC NUT

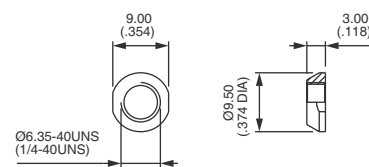

Chrome plated **U542**
Nickel plated **U561**

SEALING WASHER

for keyway bushing

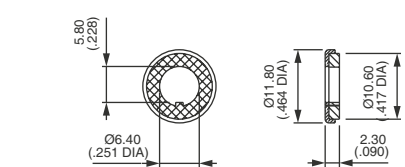

U360

SPECIAL LOCKING RING

Spacing 6,2 mm (.244)

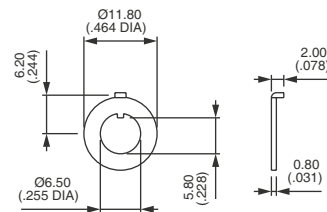

Nickel plated **U368**

SPECIAL LOCKING RING

Spacing 4,75 mm (.187)

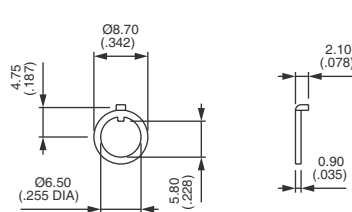

Nickel plated **U409**

SEALING WASHER

for flatted bushing

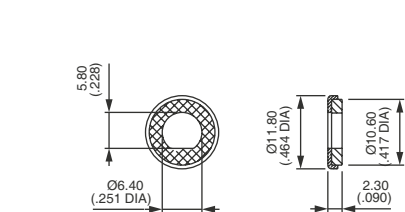

U5141

STANDARD HARDWARE FOR SWITCHES Ø 10 (.393) 10400 AND 10600 SERIES

KNURLED CAP NUT
STD FOR 10600

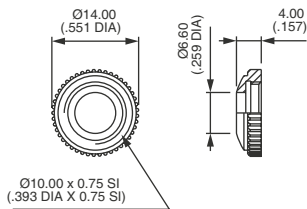

Chrome plated U2220

KNURLED NUT
STD FOR 10400

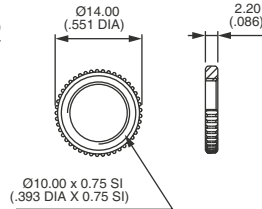

Nickel plated U2311

HEX NUT

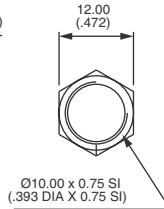

Nickel plated U842

LOCKING RING

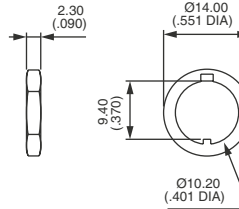

Nickel plated U844

LOCKWASHER

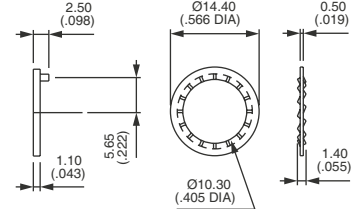

Zinc plated steel U843

STANDARD HARDWARE FOR SWITCHES Ø 11.9 (15/32) 12000, 13000X768 AND 5600M SERIES

HEX NUT

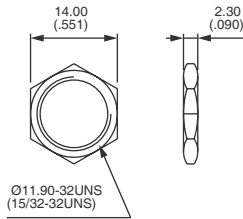

Nickel plated U162
Black U41

LOCKING RING

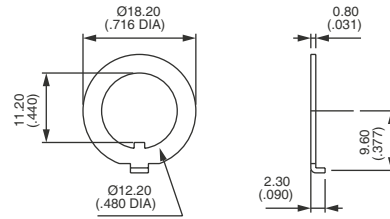

Nickel plated U121
Black U12

SERIES	HARDWARE SUPPLIED	
	HEX NUT	LOCKING RING
12000	2	1
13000X768	1	-
5600M	2	1
8000X718	2	1

NON-STANDARD HARDWARE FOR SWITCHES Ø 11.9 (15/32) 12000, 13000X768 AND 5600M SERIES

KNURLED NUT

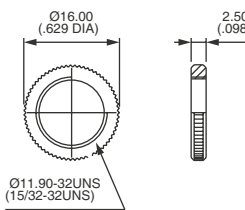

Nickel plated U53
Black U1634

KNURLED CAP NUTS

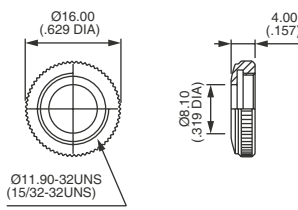

Chrome plated U124

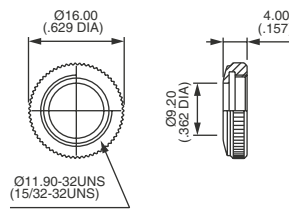

Chrome plated U123

LOCKWASHER

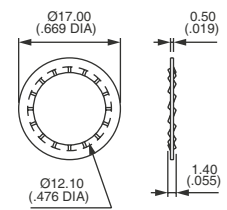

Zinc plated steel U13

OTHER HARDWARE

SEALING WASHER

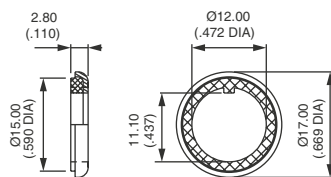

U60

WRENCHES

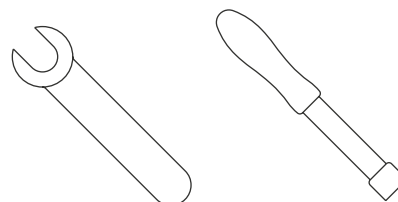

Available for some accessories.
Consult factory.

Hardware

For miniature and industrial switches

NUTS FOR BUSHING Ø 11.9 (15/32) AND Ø 12 (.472)

- Standard hardware is indicated by darkened boxes.
- For details of hardware supplied, please refer to beginning of each series.
- Special hardware is to be ordered separately.

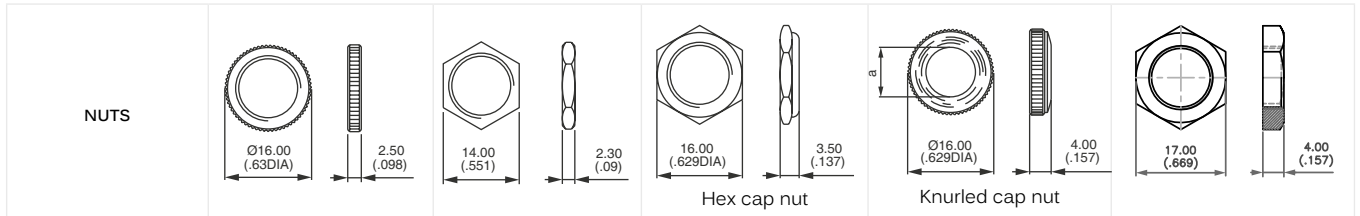

BUSHING Ø 11.9 (15/32) THREAD 0.794-32UNS SERIES 3500 - 6000				
Chrome plated brass		U92		U123
Nickel plated brass	U53	U162		
Black brass	U1634	U41		U2226
BUSHING Ø 12 (.472) THREAD 0.75 SERIES IB/IS - IC - IH - IL - IM - IP - 660 - 600H - 600NH - 1000 - 1200 - 1500 - 1600 - 1700 - 3600 - 4000				
Chrome plated brass	U412	U212	U35	U117 a = 8.5 (.334) U118 a = 10.3 (.405)
Nickel plated brass	U411	U166		U117-5 a = 8.5 (.334)
Black brass	U413	U183		U129 a = 8.5 (.334) U130 a = 10.3 (.405)
Gold plated brass	U410-4			U1862 a = 8.5 (.334)
BUSHING Ø 12 (.472) THREAD 0.75 SERIES IS, IM, IM				
Plastic				U4248

INSULATED NUTS U520 FOR BUSHING Ø 12 (.472)

NUTS	FOR THREADED BUSHING Ø 12 (.472) X 0.75 IS SERIES 1500 - 4000 - 600NH - 6-600NH							
	Blue	Black	Green	Grey	Yellow	Red	White	Chrome plated
	U521	U522	U523	U524	U525	U526	U527/1	U528

HARDWARE FOR SWITCHES Ø 12 (.472) AND 11.9 (15/32)

LOCKING RING

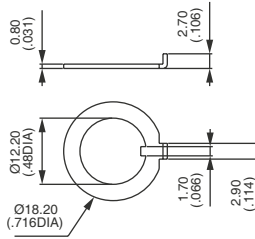

Nickel plated U121
Black U12

LOCKWASHER

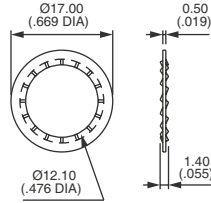

Zinc plated steel U13

SEALING WASHER

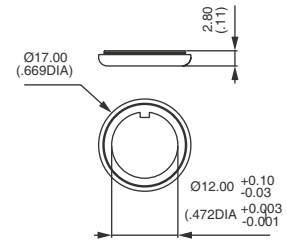

Stainless steel and neoprene U60

SEALING WASHER FOR BOOTS

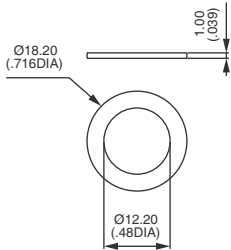

Nylon U21

GROUND CONNECTOR

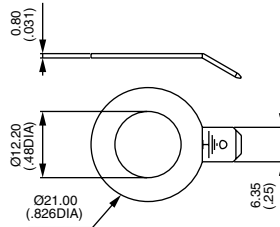

Nickel plated U187

LOCKWASHER

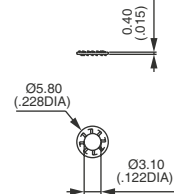

Zinc plated steel U14

The locking ring U121 (nickel plated) or U12 (black) is only provided with tropicalized switches version T or G and with series 3500 - 6000. The lockwasher U13 must be ordered separately, except for series 660, 3500 and 6000.

PLATES FOR SWITCHES Ø 12 (.472) AND 11.9 (15/32)

MARCHE - ARRÊT

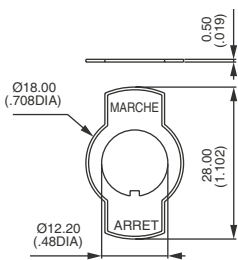

U17

ON - OFF

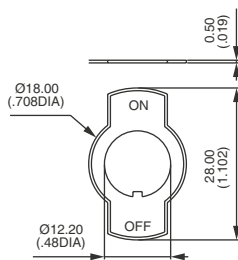

U19

EIN - AUS

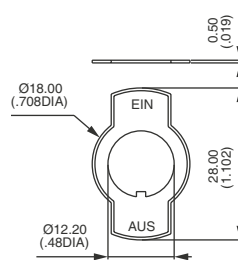

U99

I - 0

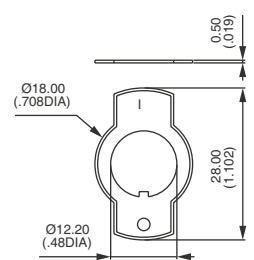

U1050

CONNECTING SCREW

SUPPLIED WITH THE SWITCHES

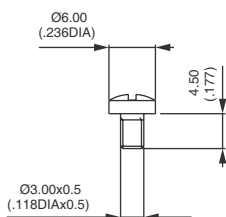

U03

Hardware

For miniature and industrial switches

HARDWARE FOR AV SERIES (ANTI-VANDAL AND SECURITY PUSHBUTTON SWITCHES)

HEX NUT FOR MODELS Ø 16 (.629)

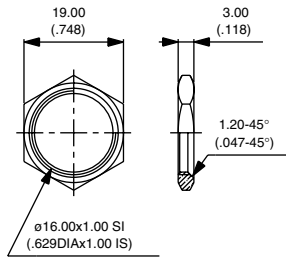

10-621

KNURLED NUT FOR MODELS Ø 16 (.629)

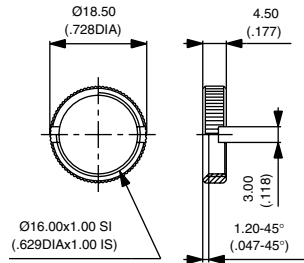

10-960-5

HEX NUT FOR MODELS Ø 19 (.748)

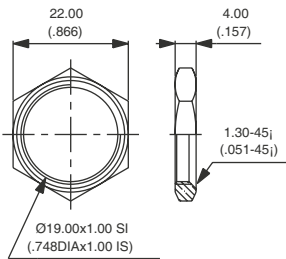

10-855-5

KNURLED NUT FOR MODELS Ø 19 (.748)

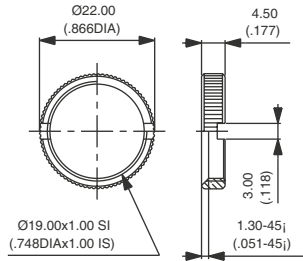

U1977-5

Wrench for nut U1977-5 available under part number U1929.

HEX NUT FOR MODELS Ø 22 (.866)

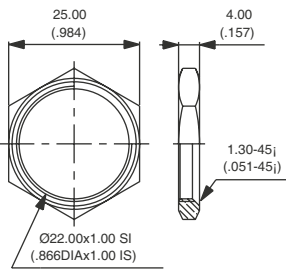

10-856-5

HEX NUT FOR MODELS Ø 24 (.944)

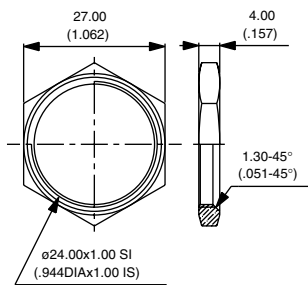

U2059-5

HEX NUT FOR MODELS Ø 30 (1.181)

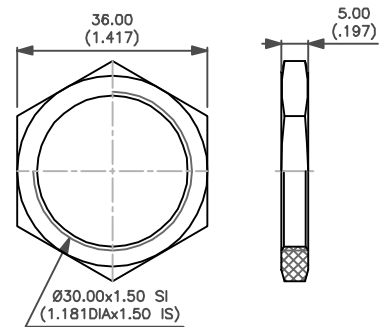

U6730

All above nuts are made of nickel plated brass (except U6730 : plastic).
For switches with front panel sealing (option K), a neoprene O-ring is supplied with each nut.

X-ON Electronics

Largest Supplier of Electrical and Electronic Components

Click to view similar products for [Switch Fixings](#) category:

Click to view products by [Apem](#) manufacturer:

Other Similar products are found below :

[893102000](#) [00-5150](#) [LZZ1A](#) [0098.9234](#) [M2PA-5011](#) [630155](#) [635401](#) [6PA113](#) [6PA147-E6](#) [6PA148-E6](#) [6PA32](#) [6PA9](#) [700106](#) [700109](#)
[700303A56](#) [700C1GRY](#) [700C2GRN](#) [704-6001](#) [704.960.9](#) [704.965.2](#) [704.965.6](#) [704.966.0](#) [7089-3](#) [710082-B11](#) [71M1048](#) [757200264](#)
[764300000](#) [MHU35](#) [MHU37](#) [807039-1](#) [825.003.011](#) [825.005.011](#) [825.053.011](#) [825.055.011](#) [826.000.071](#) [827.020.011](#) [827.400.021](#)
[835.900.023](#) [MML52C10C](#) [MML52E10C](#) [MML92HGH](#) [MML93K](#) [84211M02CNNS](#) [84212M02CNNS](#) [842.500.011](#) [843.000.011](#) [843187-000](#) [843487-000](#) [84-901](#) [84-902](#)