

Rotary Shaft Seals for Switches & Potentiometers

HEXSEAL® and E-SEEL® rotary shaft seals are molded from a high tear-strength silicone rubber (other materials available for specific environments) bonded to a built-in mounting nut. Each seal surrounds the rotary shaft and forms a watertight and dust-tight seal against the shaft and front panel surface.

SPECIFICATIONS

MaterialHEXSEALS: Silicone rubber conforms to A-A-59588, Class 3B, Gr. 60 unless otherwise specified.
E-SEELS: Silicone rubber polymer type ASTM D1418

Mounting NutHEXSEALS: Brass, nickel-plated
E-SEELS: Brass, black-oxide

Temperature Range...HEXSEALS: -94°F to +400°F (-70°C to +204°C)
E-SEELS: -80°F to +400°F (-62°C to +204°C)

Enclosure Protection..NEMA/UL/ULC Types 1, 2, 3, 3S, 3R, 4, 4X, 6P, 12, 13; IEC IP66/IP68

Pressure RangeExceeds 15 psi internal and 1500 psi external

Operational Life100,000 actuations (minimum)

Shelf LifeExcess of 25 years

Resistant to.....Salt spray, sunlight, ozone, weather, fungus, and most acids and lubricating oils

Military Specs*Most HEXSEALS meet MIL-DTL-5423. (See listing on page 6)

Agency Recognition...UL & ULC Recognized Component to UL Std. 50

Installation.....Please see installation instructions on page 19

*APM's policy is to manufacture our HEXSEAL® sealing boots as defined by the requirements of MIL-Spec MIL-DTL-5423 which we regard as the standard for the switch, circuit breaker and potentiometer industry. These requirements were formulated based on our original patent.

HOW TO ORDER

Specify APM boot part number and, if necessary, the appropriate bushing adaptor part number (please see page 19).

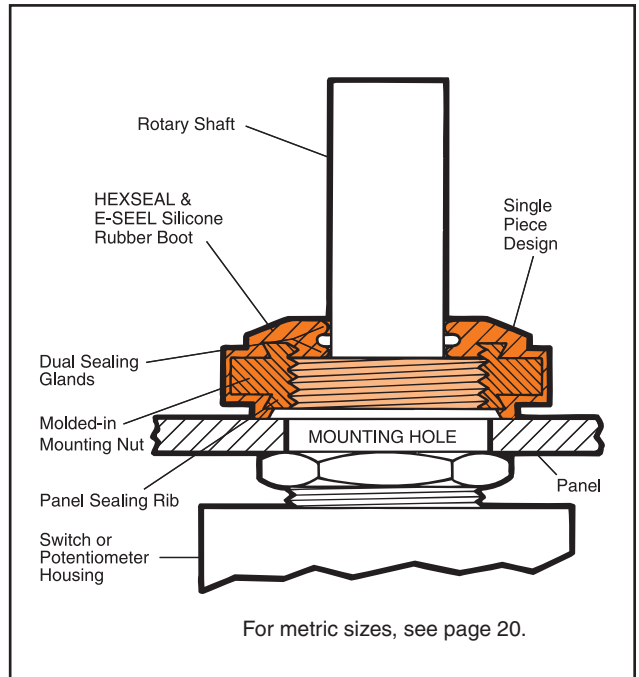
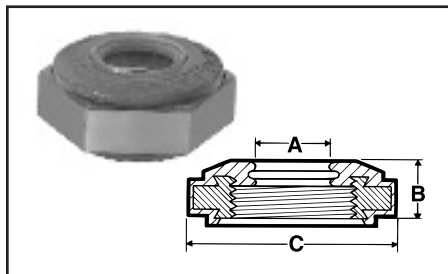

FIGURE 21 Rotary Shaft Seals – IP66/68 Rated



Thread Size**	A Shaft Size		B Height		C Flat		Military Part Number	APM Boot Part Number	Color*	HEXSEAL	E-SEEL
	inch	mm	inch	mm	inch	mm					
1/4-28NF2B	.125	3.18	.219	5.56	.375	9.53	—	N9042 x 1/8	Gray	•	
1/4-32NEF-2B	.125	3.18	.219	5.56	.375	9.53	M5423/09-03	N9040 x 1/8	Gray	•	
3/8-32NEF-2B	.125	3.18	.219	5.56	.500	12.70	M5423/09-01	N9030 x 1/8	Gray	•	
3/8-32NEF-2B	.188	4.78	.219	5.56	.500	12.70	—	N9030 x 3/16	Gray	•	
3/8-32NEF-2B	.250	6.35	.219	5.56	.500	12.70	M5423/09-02	N9030 x 1/4	Gray	•	
3/8-32NEF-2B	.250	6.35	.359	9.12	.500	12.70	—	N9033 x 1/4	Gray	•	
15/32-32NS-2B	.250	6.35	.219	5.56	.625	15.88	M5423/09-04	N9060 x 1/4	Gray	•	
1/2-32NS-2B	.250	6.35	.219	5.56	.625	15.88	M5423/09-06	N9063 x 1/4	Gray	•	
5/8-24NEF-2B	.375	9.53	.219	5.56	.750	19.05	M5423/09-05	N9065 x 3/8	Gray	•	
5/8-24NEF-2B	.500	12.70	.219	5.56	.750	19.05	—	N9065 x 1/2	Gray	•	
3/8-32NEF-2B	.250	6.35	.219	5.56	.500	12.70	—	C1332/40	Black	•	•

*Other colors available. Please consult factory. **Metric thread sizes available; consult factory.

FIGURE 22 RFI/EMI Shielded Rotary Shaft Seals – IP66/68 Rated

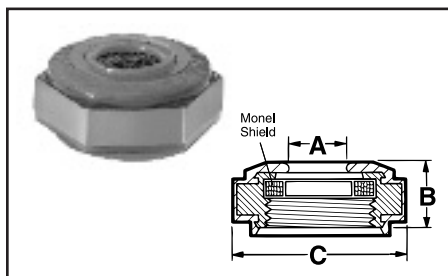

Thread Size**	A Shaft Size		B Height		C Flat		Military Part Number	APM Boot Part Number	Color*	HEXSEAL	E-SEEL
	inch	mm	inch	mm	inch	mm					
1/4-32NF2B	.125	3.18	.219	5.56	.375	9.53	M5423/09-09	N9040 x 1/8 RFI	Gray	•	
3/8-32NEF-2B	.125	3.18	.219	5.56	.500	12.70	M5423/09-07	N9030 x 1/8 RFI	Gray	•	
3/8-32NEF-2B	.250	6.35	.219	5.56	.500	12.70	M5423/09-08	N9030 x 1/4 RFI	Gray	•	
3/8-32NEF-2B	.250	6.35	.359	9.12	.500	12.70	M5423/09-14	N9033 x 1/4 RFI	Gray	•	
15/32-32NS-2B	.250	6.35	.219	5.56	.625	15.88	M5423/09-10	N9060 x 1/4 RFI	Gray	•	
5/8-24NEF-2B	.375	9.53	.219	5.56	.750	19.05	M5423/09-11†	N9065 x 3/8 RFI	Gray	•	
1/2-32NS-2B	.250	6.35	.219	5.56	.625	15.88	M5423/09-12	N9063 x 1/4 RFI	Gray	•	
1/4-28NF-2B	.125	3.18	.219	5.56	.375	9.53	—	N9042 x 1/8 RFI	Gray	•	
3/8-32NEF-2B	.125	3.18	.531	13.49	.625	15.88	—	NLK9030 x 1/8 RFI	Gray	•	
3/8-32NEF-2B	.250	6.35	.531	13.49	.625	15.88	—	NLK9030 x 1/4 RFI	Gray	•	

*Other colors available. Please consult factory. †Inactive for new designs. **Metric thread sizes available; consult factory. All Standard RFI/EMI boots feature knitted Monel wire shields.

FIGURE 23 Locking Rotary Shaft Seals – IP66/68 Rated

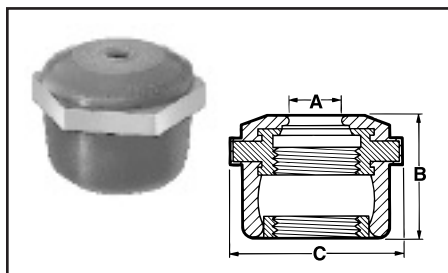

Thread Size	A Shaft Size		B Height		C Flat		Lock Nut O.D.	Military Part Number	APM Boot Part Number	Color*	HEXSEAL	E-SEEL
	inch	mm	inch	mm	inch	mm						
1/4-32NS-2B	.125	3.18	.500	12.70	.500	12.70	.344 8.74	—	NLK9040 x 1/8	Gray	•	
3/8-32NS-2B	.125	3.18	.531	13.49	.625	15.88	.469 11.91	—	NLK9030 x 1/8	Gray	•	
3/8-32NS-2B	.250	6.35	.531	13.49	.625	15.88	.469 11.91	—	NLK9030 x 1/4	Gray	•	

*Other colors available. Please consult factory.

DIMENSIONS FOR REFERENCE ONLY.

Current dimensional drawings can be viewed on our website and CAD drawings can also be downloaded.



METRIC Sizes for Toggle, Pushbutton and Rotary Switches and Circuit Breakers

SPECIFICATIONS

Material.....Silicone rubber polymer type ASTM D 1418
Mounting Nut.....Brass, black-oxide. *Brass, nickel-plated.
Temperature Range....-80°F to +400°F (-62°C to +204°C)
Enclosure Protection..NEMA/UL/ULC Types 1, 2, 3, 3S, 3R, 4, 4X, 6P, 12, 13; IEC IP66/IP68
Pressure Range.....Exceeds 15 psi internal and 1500 psi external
Operational Life.....100,000 actuations (minimum)
Shelf Life.....Excess of 25 years
Resistant to.....Salt spray, sunlight, ozone, weather, fungus, and most acids and lubricating oils
Agency Recognition...UL & ULC Recognized Component to UL Std. 50
Installation.....Please see installation instructions on page 19

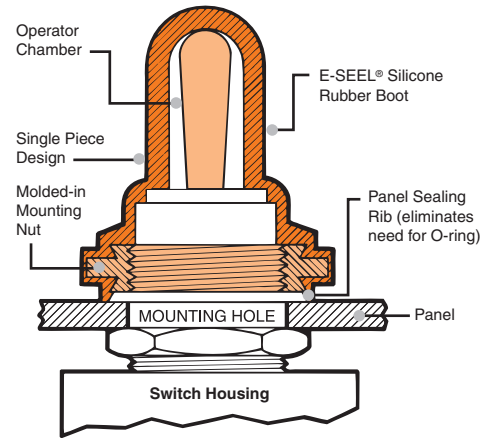

Additional metric sizes available (consult factory)

TOGGLE SWITCH BOOTS

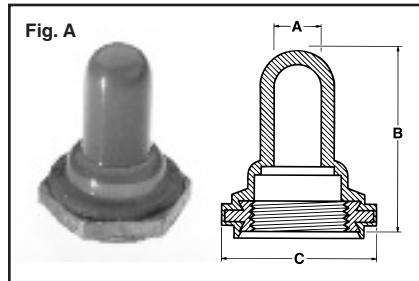

IP66/IP68/NEMA 6P Enclosure Protection

Full Toggle (with Constant I.D.) Switch Boots (covers all external portions of switch & seals switch mounting hole)

Figure A

Thread Size	Throat Size ¹ ("A")		Max Toggle Height ²		Max Boot Height ("B")		Flat ("C")		Color	APM Cat. No.
	mm	in.	mm	in.	mm	in.	mm	in.		
M6 X 0.75	2.9	0.116	10.8	0.43	14.3	0.562	9.0	0.352	Black	1131/25*
M12 X 0.75	5.3	0.21	16.2	0.64	21.6	0.85	15.8	0.625	Black	C1131/41
M12 X 0.75	5.5	0.219	22.8	0.90	27.7	1.1	15.8	0.625	Black	1131/26-M12-.75
M12 X 1	6.5	0.256	16.7	0.66	21.4	0.844	15.8	0.625	Black	1131/31-M12
M12 X 1	5.9	0.234	16.9	0.66	21.8	0.859	15.8	0.625	Black	1131/40
M12 X 1	5.5	0.219	22.8	0.90	27.7	1.1	15.8	0.625	Black	1131/26-M12-.10

¹ Throat size is the maximum diameter of the switch toggle/handle (Dimension "A").

² Max toggle height is the maximum distance from the end of the switch mounting stem to the end of the switch toggle.

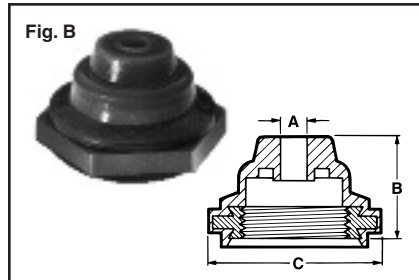

IP66/IP68/NEMA 6P Enclosure Protection

Half Toggle Switch Boots (Seals switch mounting stem & hole; toggle actuator protrudes)

Figure B

Thread Size	Throat Size ("A")		Toggle Diameter Accomodated		Max Boot Height ("B")		Flat ("C")		Color	APM Cat. No.
	mm	in.	mm	in.	mm	in.	mm	in.		
M5 X 0.5	1.1	0.42	1.57-4.57	0.062-0.18	5.7	0.225/0.25	7.9	0.313	Black	1132/17-M5-5
M12 X 1	2.36	0.093	2.92-6.09	0.115-0.24	11.1	0.437	15.9	0.625	Black	1132/33-M12-1

PUSHBUTTON SWITCHES & CIRCUIT BREAKERS/PROTECTORS

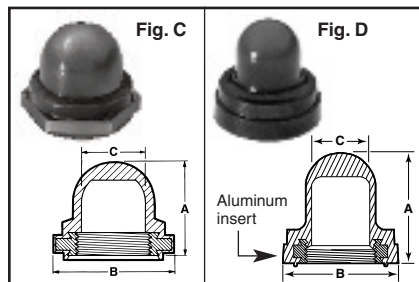

IP66/IP68/NEMA 6P Enclosure Protection

Half Toggle Switch Boots (Seals switch mounting stem & hole; toggle actuator protrudes)

Figures C & D

Thread Size ¹	Max Boot Height ("A")		Max Plunger Height		Dimension "B"		Max Plunger Diameter ("C")		Color ¹	APM Cat. No.	Fig.
	mm	in.	mm	in.	mm	in.	mm	in.			
M10 X 1	15.47	0.62	8.4	0.33	16.3	0.64	8.1	0.32	Black	C1221/21	D
M11 X 1	15.47	0.62	11.9	0.469	18.3	0.72	10.72	0.422	Clear	C1221/27	D
M12 X 1	18.64	0.47	11.9	0.469	15.9	0.625	10.72	0.422	Black	NC3030H-M12-1	C

¹ "Clear" allows viewing of breaker amp rating and trip state; please enquire for other available colors.

ROTARY SHAFT SEALS

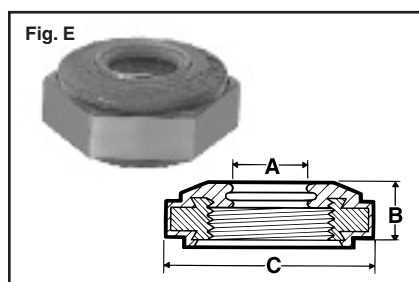

IP66/IP68/NEMA 6P Enclosure Protection

Seal the shaft and mounting hole of standard rotary switches/potentiometers that use a threaded stem and nut mounting.

Figure E

Thread Size	Shaft Size ¹ ("A")		Height ("B")		Flat ("C")		Color ²	APM Cat. No.
	mm	in.	mm	in.	mm	in.		
M7 X 0.75	5.0	0.2	5.5	0.2	12.7	0.500	Gray	1332/39-2*
M9 X 0.75	6.35	0.250	5.56	0.219	12.7	0.500	Gray	C1332/41*
M10 X 1	6.0	0.236	5.9	0.236	12.7	0.500	Gray	1332/45*

¹ Switch/potentiometer shaft must have a smooth, round cross-section where it meets the sealing edge of the shaft seal device.

² Please enquire for other available colors.

X-ON Electronics

Largest Supplier of Electrical and Electronic Components

Click to view similar products for [apm manufacturer](#):

Other Similar products are found below :

[ENGINEERING KIT-4](#) [N3040](#) [NH3030 RFI](#) [ST1/4-20X1](#) [C1131/28 2201](#) [NC3030 2513](#) [75163](#) [RM5X12MM 2701](#) [#4 Engineering Kit 2701](#)
[#6 Engineering Kit 2701](#) [RM3x8mm-4601 BLKOX](#) [R10-24X1/2](#) [ENGINEERING KIT-8](#) [R2-56X78](#) [ENGINEERING KIT-6](#) [ST3/8-16X3/4](#)
[1113/43](#) [R6-32X5/16-2701BLKOX](#) [R8-32 x 58 2615](#) [1813/22LW19-4](#) [74402](#) [75031](#) [1231/27](#) [60220 EPDM](#) [M5 AJ 6 SS](#) [74302](#) [R2-56X1](#)
[R8-32X916](#) [M542310-02](#) [5/16-18 AJ 6](#) [1113/40](#) [RM2.5x6MM 2701](#) [75472](#) [111347](#) [75123](#) [123132](#) [HE1076](#) [10-24 AJ 6](#) [SFR8-32X3/8-](#)
[2615-TP](#) [75142](#) [1/2-13 AJ 6](#) [12381](#) [4082](#) [SFR8-32x1-2701](#) [N-1002](#) [113160 2201](#) [HE-1040](#) [1/4-28 AJ 6](#) [N5030S](#) [75603-EPDM](#)