

## -30V P-Channel Enhancement Mode MOSFET

### Description

The AP9435A uses advanced trench technology to provide excellent  $R_{DS(ON)}$ , low gate charge and operation with gate voltages as low as 4.5V. This device is suitable for use as a Battery protection or in other Switching application.

### General Features

$V_{DS} = -30V$   $I_D = -6A$

$R_{DS(ON)} < 55m\Omega$  @  $V_{GS}=10V$

### Application

Battery protection  
 Load switch  
 Uninterruptible power supply

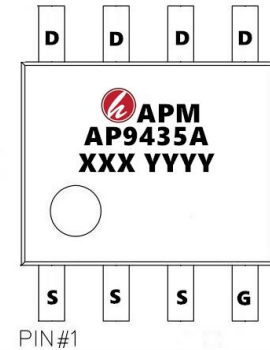
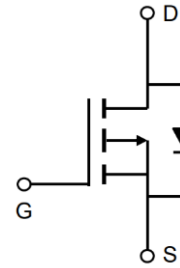

### Package Marking and Ordering Information

Product ID	Pack	Marking	Qty(PCS)
AP9435A	SOP-8	AP9435A XXXX YYYY	3000

### Absolute Maximum Ratings ( $T_C=25^\circ C$ unless otherwise noted)

Symbol	Parameter	Max.	Units
$V_{DSS}$	Drain-Source Voltage	-30	V
$V_{GSS}$	Gate-Source Voltage	$\pm 20$	V
$I_D @ T_C=25^\circ C$	Continuous Drain Current, $V_{GS} @ -10V^1$	-6.0	A
$I_D @ T_C=100^\circ C$	Continuous Drain Current, $V_{GS} @ -10V^1$	-3.3	A
IDM	Pulsed Drain Current <sup>note1</sup>	-20.4	A
$P_D$	Power Dissipation $T_A = 25^\circ C$	2.15	W
R $\theta$ JA	Thermal Resistance, Junction to Ambient	58	$^\circ C/W$
TJ, TSTG	Operating and Storage Temperature Range	-55 to +150	$^\circ C$



## -30V P-Channel Enhancement Mode MOSFET

### Electrical Characteristics (T<sub>J</sub>=25 °C, unless otherwise noted)

Symbol	Parameter	Test Condition	Min.	Typ.	Max.	Units
V(BR)DSS	Drain-Source Breakdown Voltage	V <sub>GS</sub> =0V, I <sub>D</sub> = -250μA	-30	-33	-	V
IDSS	Zero Gate Voltage Drain Current	V <sub>DS</sub> = -30V, V <sub>GS</sub> = 0V,	-	-	-1	μA
IGSS	Gate to Body Leakage Current	V <sub>DS</sub> =0V, V <sub>GS</sub> = ±20V	-	-	±100	nA
VGS(th)	Gate Threshold Voltage	V <sub>DS</sub> = V <sub>GS</sub> , I <sub>D</sub> = -250μA	-1.0	-1.6	-2.5	V
RDS(on)	Static Drain-Source on-Resistance note2	V <sub>GS</sub> = -10V, I <sub>D</sub> = -5A	-	43	55	mΩ
		V <sub>GS</sub> = -4.5V, I <sub>D</sub> = -4A	-	65	90	
C <sub>iss</sub>	Input Capacitance	V <sub>DS</sub> = -15V, V <sub>GS</sub> = 0V, f = 1.0MHz	-	596	-	pF
C <sub>oss</sub>	Output Capacitance		-	95	-	pF
C <sub>rss</sub>	Reverse Transfer Capacitance		-	68	-	pF
Q <sub>g</sub>	Total Gate Charge	V <sub>DS</sub> = -15V, I <sub>D</sub> = -5.1A, V <sub>GS</sub> = -10V	-	6.8	-	nC
Q <sub>gs</sub>	Gate-Source Charge		-	1	-	nC
Q <sub>gd</sub>	Gate-Drain("Miller") Charge		-	1.4	-	nC
td(on)	Turn-on Delay Time	V <sub>DD</sub> = -15V, I <sub>D</sub> = -1A, V <sub>GS</sub> =-10V, R <sub>GEN</sub> =2.5Ω	-	14	-	ns
t <sub>r</sub>	Turn-on Rise Time		-	61	-	ns
td(off)	Turn-off Delay Time		-	19	-	ns
t <sub>f</sub>	Turn-off Fall Time		-	10	-	ns
IS	Maximum Continuous Drain to Source Diode Forward Current		-	-	-5.1	A
ISM	Maximum Pulsed Drain to Source Diode Forward Current		-	-	-20.4	A
VSD	Drain to Source Diode Forward Voltage	V <sub>GS</sub> = 0V, I <sub>S</sub> = -5.1A	-	-0.8	-1.2	V

Note :

- 1、 The data tested by surface mounted on a 1 inch 2 FR-4 board with 2OZ copper.
- 2、 The data tested by pulsed , pulse width ≅ 300us , duty cycle ≅ 2%
- 3、 The EAS data shows Max. rating . The test condition is VDD=-25V,VGS=-10V,L=0.1mH,IAS=-5A
- 4、 The power dissipation is limited by 150°C junction temperature
- 5、 The data is theoretically the same as ID and IDM , in real applications , should be limited by total power dissipation.

**Typical Characteristics**

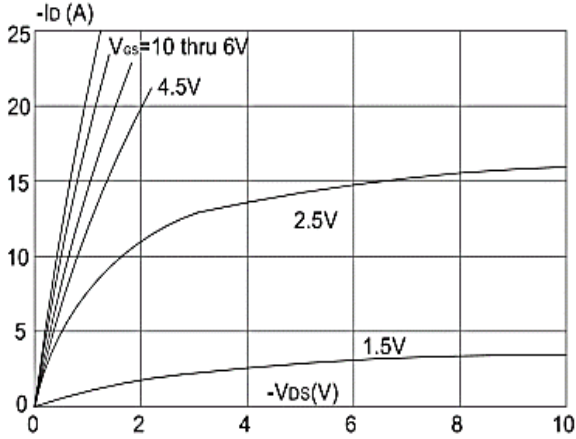

**Figure 1: Output Characteristics**

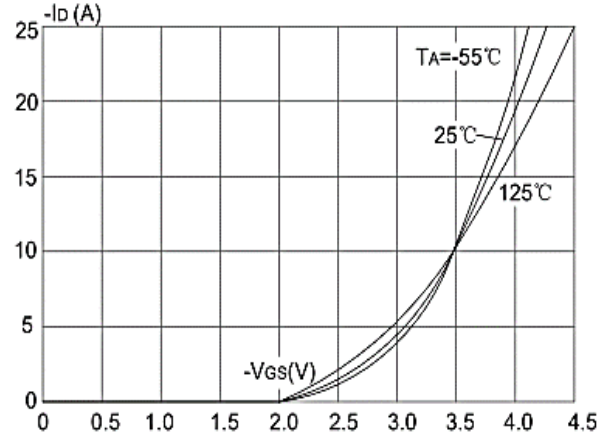

**Figure 2: Typical Transfer Characteristics**

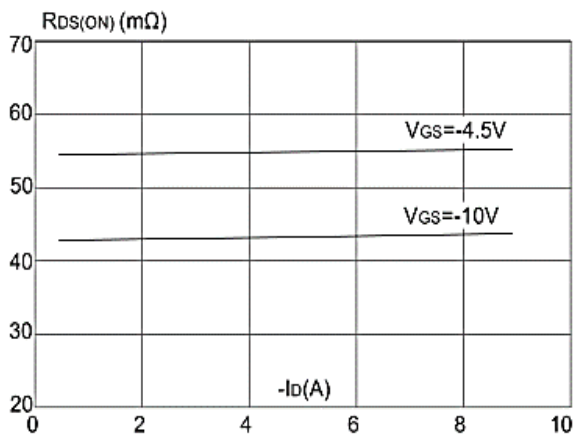

**Figure 3: On-resistance vs. Drain Current**

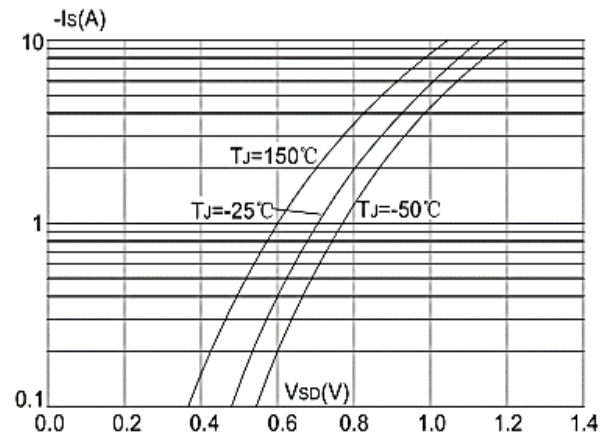

**Figure 4: Body Diode Characteristics**

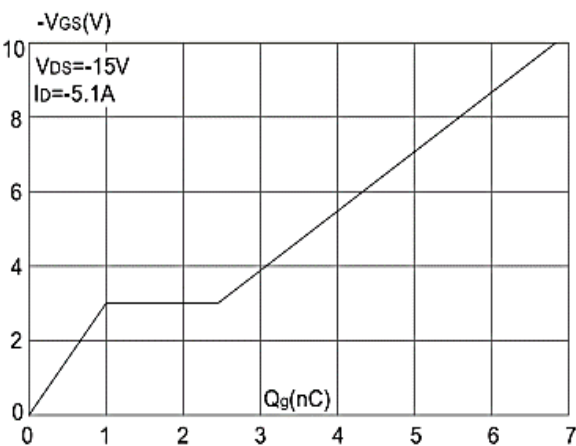

**Figure 5: Gate Charge Characteristics**

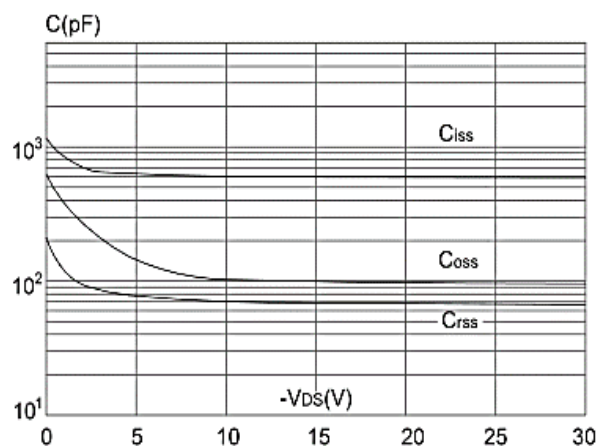

**Figure 6: Capacitance Characteristics**



**-30V P-Channel Enhancement Mode MOSFET**

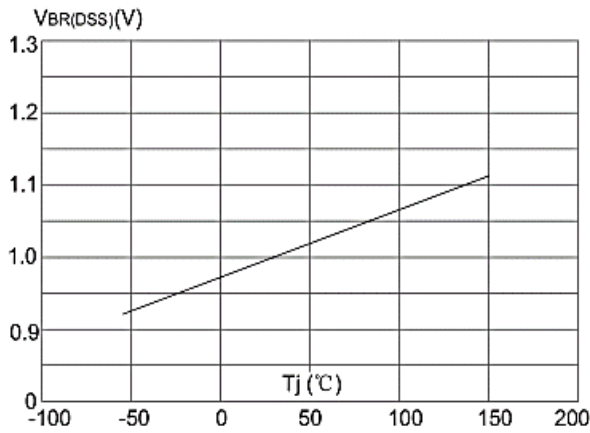

**Figure 7: Normalized Breakdown Voltage vs. Junction Temperature**

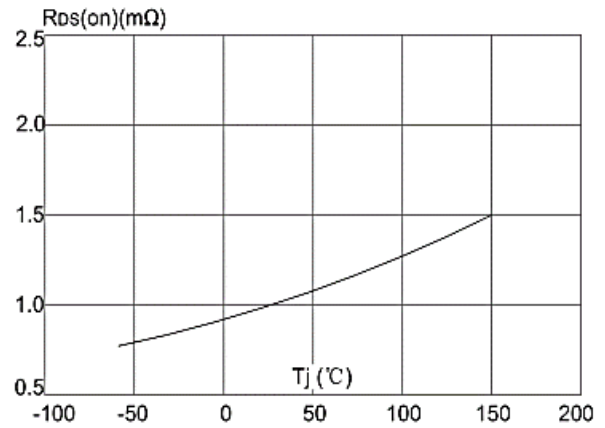

**Figure 8: Normalized on Resistance vs. Junction Temperature**

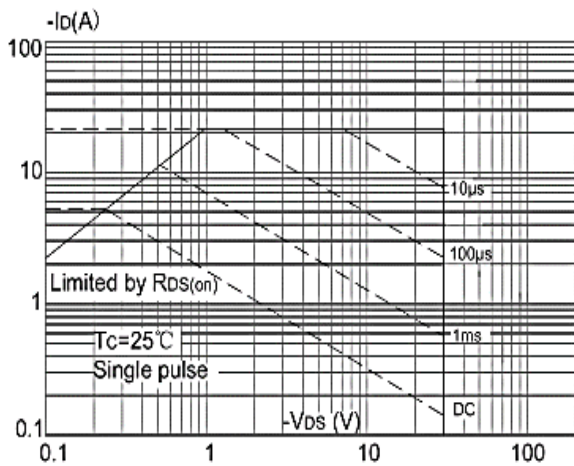

**Figure 9: Maximum Safe Operating Area vs. Case Temperature**

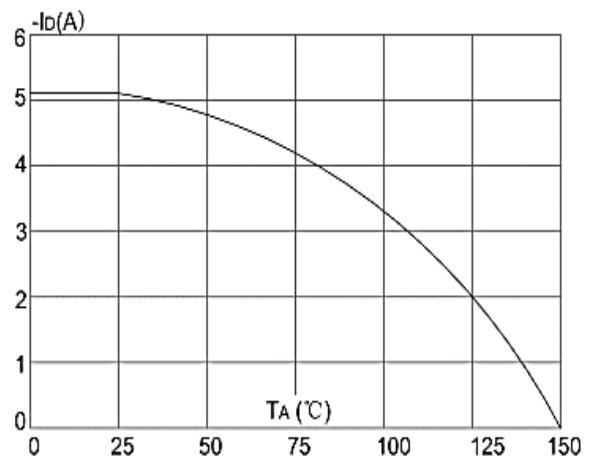

**Figure 10: Maximum Continuous Drain Current vs. Ambient Temperature**

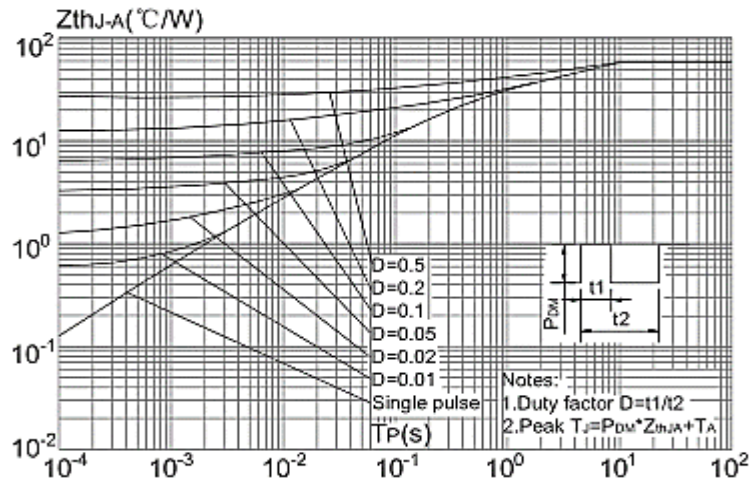

**Figure.11: Maximum Effective Thermal Impedance vs. Pulse Width**

Transient Thermal Impedance, Junction-to-Case

### Package Mechanical Data-SOP-8

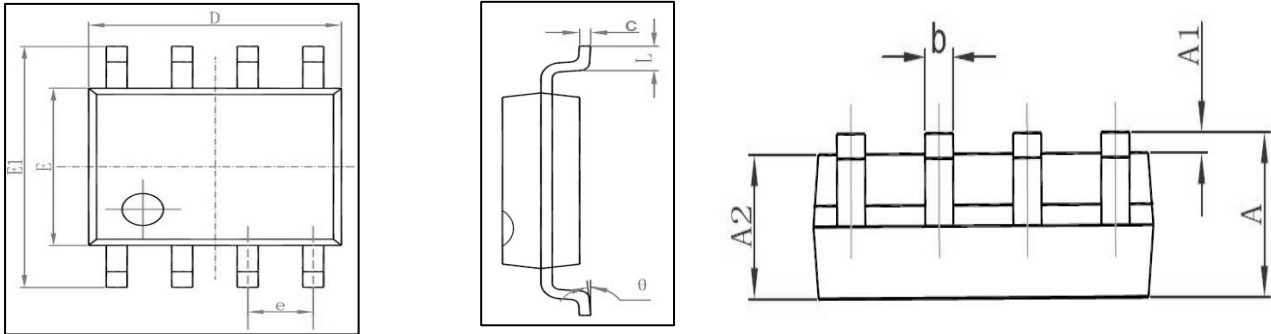

Symbol	Dimensions In Millimeters		Dimensions In Inches	
	Min	Max	Min	Max
A	1.350	1.750	0.053	0.069
A1	0.100	0.250	0.004	0.010
A2	1.350	1.550	0.053	0.061
b	0.330	0.510	0.013	0.020
c	0.170	0.250	0.006	0.010
D	4.700	5.100	0.185	0.200
E	3.800	4.000	0.150	0.157
E1	5.800	6.200	0.228	0.244
e	1.270 (BSC)		0.050 (BSC)	
L	0.400	1.270	0.016	0.050
θ	0°	8°	0°	8°

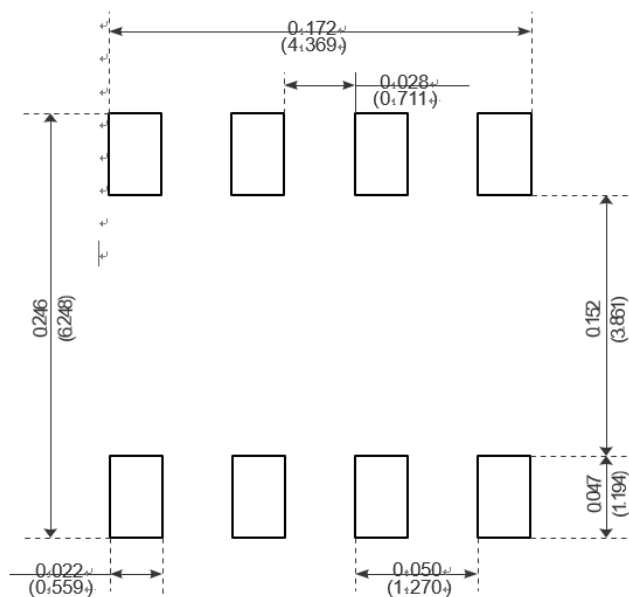

Recommended Minimum Pads

**-30V P-Channel Enhancement Mode MOSFET****Attention**

1, Any and all APM Microelectronics products described or contained herein do not have specifications that can handle applications that require extremely high levels of reliability, such as life support systems, aircraft's control systems, or other applications whose failure can be reasonably expected to result in serious physical and/or material damage. Consult with your APM Microelectronics representative nearest you before using any APM Microelectronics products described or contained herein in such applications.

2, APM Microelectronics assumes no responsibility for equipment failures that result from using products at values that exceed, even momentarily, rated values (such as maximum ratings, operating condition ranges, or other parameters) listed in products specifications of any and all APM Microelectronics products described or contained herein.

3, Specifications of any and all APM Microelectronics products described or contained here stipulate the performance, characteristics, and functions of the described products in the independent state, and are not guarantees of the performance, characteristics, and functions of the described products as mounted in the customer's products or equipment. To verify symptoms and states that cannot be evaluated in an independent device, the customer should always evaluate and test devices mounted in the customer's products or equipment.

4, APM Microelectronics Semiconductor CO., LTD. strives to supply high quality high reliability products. However, any and all semiconductor products fail with some probability. It is possible that these probabilistic failures could give rise to accidents or events that could endanger human lives that could give rise to smoke or fire, or that could cause damage to other property. When designing equipment, adopt safety measures so that these kinds of accidents or events cannot occur. Such measures include but are not limited to protective circuits and error prevention circuits for safe design, redundant design, and structural design.

5, In the event that any or all APM Microelectronics products (including technical data, services) described or contained herein are controlled under any of applicable local export control laws and regulations, such products must not be exported without obtaining the export license from the authorities concerned in accordance with the above law.

6, No part of this publication may be reproduced or transmitted in any form or by any means, electronic or mechanical, including photocopying and recording, or any information storage or retrieval system, or otherwise, without the prior written permission of APM Microelectronics Semiconductor CO., LTD.

7, Information (including circuit diagrams and circuit parameters) herein is for example only; it is not guaranteed for volume production. APM Microelectronics believes information herein is accurate and reliable, but no guarantees are made or implied regarding its use or any infringements of intellectual property rights or other rights of third parties.

8, Any and all information described or contained herein are subject to change without notice due to product/technology improvement, etc. When designing equipment, refer to the "Delivery Specification" for the APM Microelectronics product that you intend to use.

**-30V P-Channel Enhancement Mode MOSFET**

<b>Edition</b>	<b>Date</b>	<b>Change</b>
Rve3.8	2018/11/31	Initial release
Rve3.9	2020/5/31	Reduce RDS(on)

**Copyright Attribution“APM-Microelectronice”**

## X-ON Electronics

Largest Supplier of Electrical and Electronic Components

*Click to view similar products for [MOSFET](#) category:*

*Click to view products by [APM Microelectronics](#) manufacturer:*

Other Similar products are found below :

[IRFD120](#) [JANTX2N5237](#) [BUK455-60A/B](#) [MIC4420CM-TR](#) [VN1206L](#) [NDP4060](#) [SI4482DY](#) [IPS70R2K0CEAKMA1](#) [SQD23N06-31L-GE3](#)  
[TK16J60W,S1VQ\(O](#) [2SK2614\(TE16L1,Q\)](#) [DMN1017UCP3-7](#) [DMN1053UCP4-7](#) [SQJ469EP-T1-GE3](#) [NTE2384](#) [DMC2700UDMQ-7](#)  
[DMN2080UCB4-7](#) [DMN61D9UWQ-13](#) [US6M2GTR](#) [DMN31D5UDJ-7](#) [DMP22D4UFO-7B](#) [DMN1006UCA6-7](#) [DMN16M9UCA6-7](#)  
[STF5N65M6](#) [IRF40H233XTMA1](#) [STU5N65M6](#) [DMN6022SSD-13](#) [DMN13M9UCA6-7](#) [DMTH10H4M6SPS-13](#) [DMN2990UFB-7B](#)  
[IPB80P04P405ATMA2](#) [2N7002W-G](#) [MCAC30N06Y-TP](#) [MCQ7328-TP](#) [BXP7N65D](#) [BXP4N65F](#) [AOL1454G](#) [WMJ80N60C4](#) [BXP2N20L](#)  
[BXP2N65D](#) [BXT1150N10J](#) [BXT1700P06M](#) [TSM60NB380CP ROG](#) [RQ7L055BGTCR](#) [DMNH15H110SK3-13](#) [SLF10N65ABV2](#)  
[BSO203SP](#) [BSO211P](#) [IPA60R230P6](#) [IPA60R460CE](#)