

Description

The AU0561M1 is a bi-directional TVS diode, utilizing leading monolithic silicon technology to provide fast response time, very low capacitance and low ESD clamping voltage, making this device an ideal solution for protecting voltage sensitive data and power line. The AU0561M1 complies with the IEC 61000-4-2 (ESD) with $\pm 15\text{kV}$ air and $\pm 8\text{kV}$ contact discharge. It is assembled into an ultra-small 0402 package. The small size and very low capacitance make AU0561M1 an ideal choice to protect cell phone, digital cameras, audio players, data interface and many other portable applications.

Features

- Ultra small package: 1.0x0.55x0.55mm
- Protects one data or power line
- Very low capacitance: 2.5pF typical
- Ultra low leakage: nA level
- Operating voltage: 5V
- Low clamping voltage
- 2-pin leadless package
- Complies with following standards:
 - IEC 61000-4-2 (ESD) immunity test
Air discharge: $\pm 15\text{kV}$
Contact discharge: $\pm 8\text{kV}$
 - EC61000-4-5 (Lightning) 2A (8/20 μs)
- RoHS compliant

Mechanical Characteristics

- Package: 0402
- Lead Finish: Sn
- Case Material: “Green” Molding Compound.
- Moisture Sensitivity: Level 3 per J-STD-020
- Terminal Connections: See Diagram Below
- Marking Information: See Below

Applications

- Cellular Handsets and Accessories
- Personal Digital Assistants
- Notebooks and Handhelds
- Portable Instrumentation
- Digital Cameras
- Peripherals
- Audio Players
- Keypads, Side Keys, USB 2.0, LCD Displays

Ordering Information

Part Number	Packaging	Reel Size
AU0561M1	10000/Tape & Reel	7 inch

Dimensions and Pin Configuration

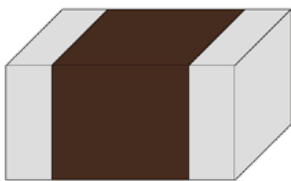

Package Outline

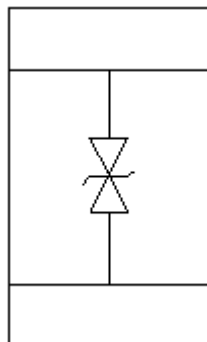

Circuit Schematic

Absolute Maximum Ratings ($T_A=25^{\circ}\text{C}$ unless otherwise specified)

Parameter	Symbol	Value	Unit
ESD per IEC 61000-4-2 (Air)	VESD	±15	kV
ESD per IEC 61000-4-2 (Contact)		±8	
Operating Temperature Range	TJ	-55 to +125	°C
Storage Temperature Range	Tstg	-55 to +150	°C

Electrical Characteristics ($T_A=25^{\circ}\text{C}$ unless otherwise specified)

Parameter	Symbol	Min	Typ	Max	Unit	Test Condition
Reverse Working Voltage	VRWM			5	V	
Breakdown Voltage	VBR	6		9	V	$I_T = 1\text{mA}$
Reverse Leakage Current	I_R			0.2	μA	$V_{RWM} = 5\text{V}$
Clamping Voltage	VC			10	V	$I_{PP} = 1\text{A}$ (8 x 20μs pulse)
Junction Capacitance	CJ		2.5		pF	$V_R = 0\text{V}$, $f = 1\text{MHz}$

Typical Performance Characteristics ($T_A=25^\circ\text{C}$ unless otherwise Specified)

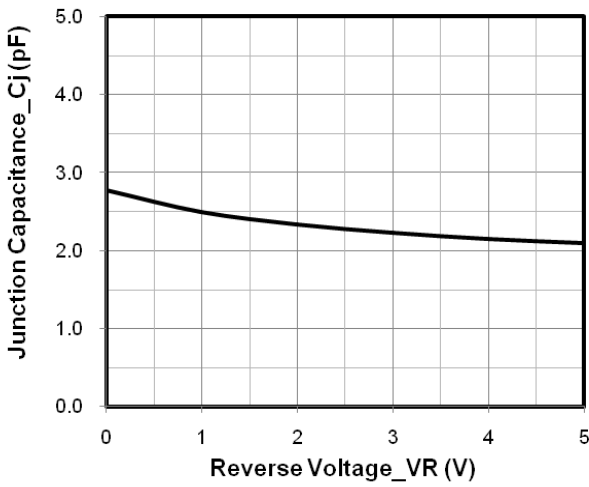

Junction Capacitance vs. Reverse Voltage

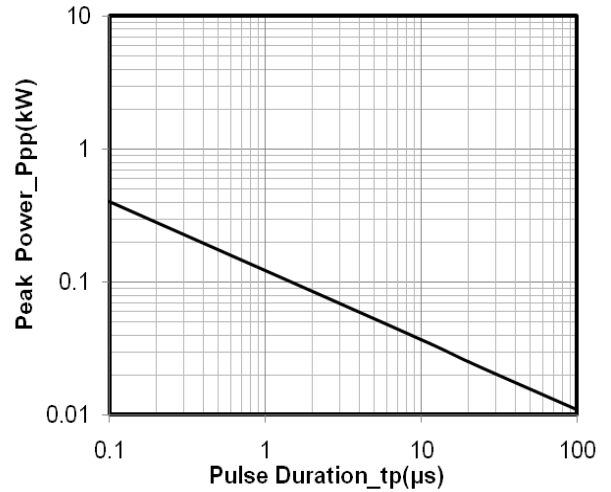

Peak Pulse Power vs. Pulse Time

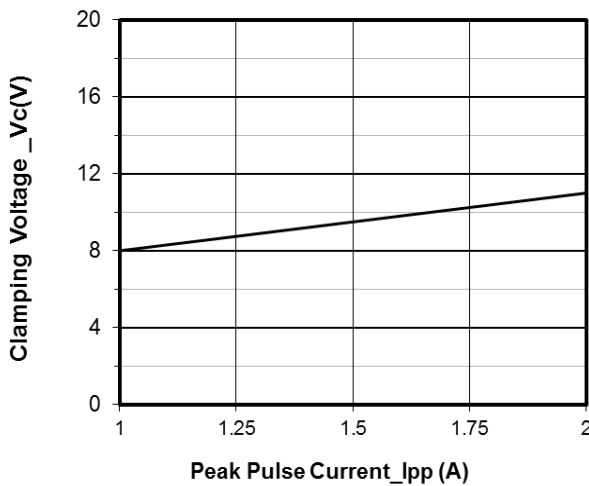

Clamping Voltage vs. Peak Pulse Current ($t_p = 8/20\mu\text{s}$)

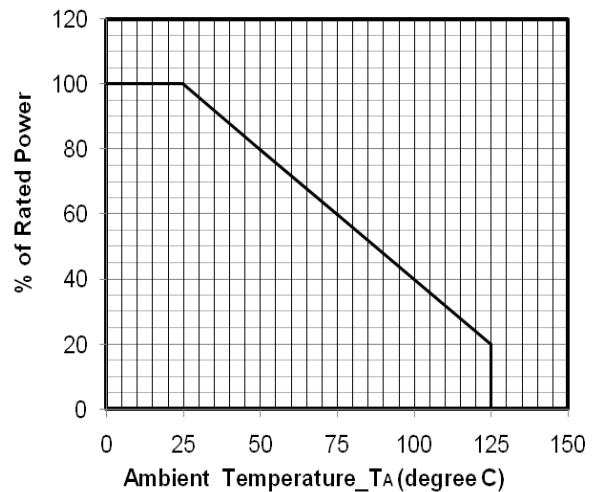

Power Derating Curve

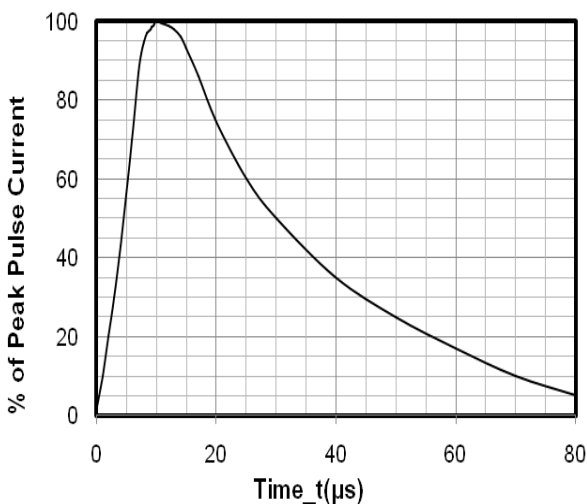

8 X 20μs Pulse Waveform

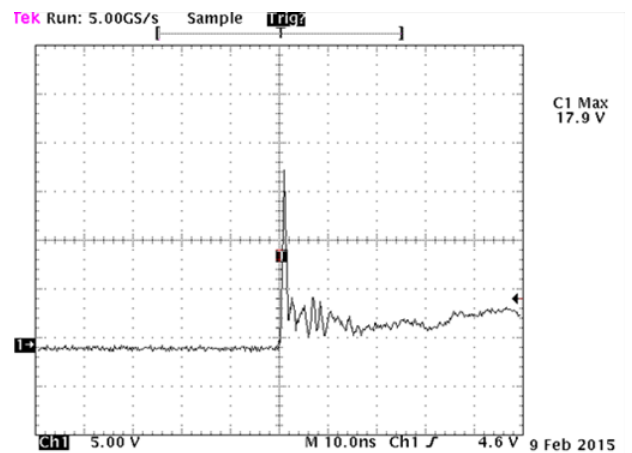

Note: Data is taken with a 10x attenuator

ESD Clamping Voltage

+8 kV Contact per IEC61000-4-2

0402 Package Outline Drawing

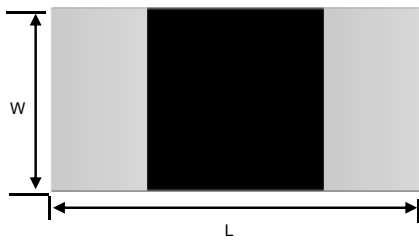

Top View

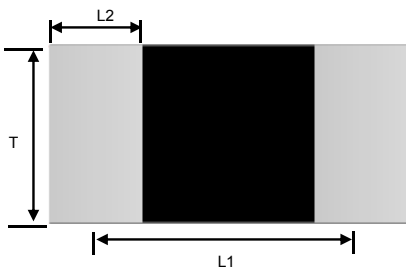

Side View

SYM	DIMENSIONS					
	MILLIMETERS			INCHES		
	MIN	NOM	MAX	MIN	NOM	MAX
W	0.45	0.55	0.65	0.018	0.022	0.026
L	0.95	1.00	1.05	0.038	0.040	0.042
T	0.45	0.55	0.65	0.018	0.022	0.026
L1	0.75 BSC			0.030 BSC		
L2	0.15	0.20	0.25	0.006	0.008	0.010

Suggested Land Pattern

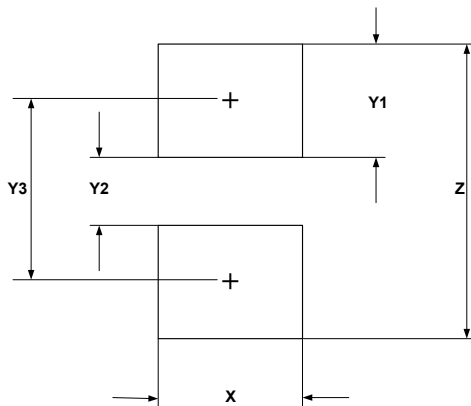

SYM	DIMENSIONS	
	MILLIMETERS	INCHES
X	0.60	0.024
Y1	0.50	0.020
Y2	0.30	0.012
Y3	0.80	0.032
Z	1.30	0.052

Contact Information

Applied Power Microelectronics Co., Ltd.

Website: <http://www.appliedpowermicro.com>

Email: sales@appliedpowermicro.com

Phone: +86 (0519) 8399 3606

X-ON Electronics

Largest Supplier of Electrical and Electronic Components

Click to view similar products for [ESD Suppressors / TVS Diodes](#) category:

Click to view products by [Applied Power](#) manufacturer:

Other Similar products are found below :

[60KS200C](#) [D18V0L1B2LP-7B](#) [D5V0F4U5P5-7](#) [NTE4902](#) [P4KE27CA](#) [P6KE11CA](#) [P6KE8.2A](#) [SA60CA](#) [SA64CA](#) [SMBJ12CATR](#)
[SMBJ33CATR](#) [SMBJ6.5A](#) [SMBJ8.0A](#) [ESD101-B1-02ELS E6327](#) [ESD112-B1-02EL E6327](#) [ESD7451N2T5G](#) [19180-510](#) [CPDT-5V0USP-](#)
[HF](#) [3.0SMCJ33CA-F](#) [3.0SMCJ36A-F](#) [HSPC16701B02TP](#) [JANTX1N6126A](#) [D3V3Q1B2DLP3-7](#) [D55V0M1B2WS-7](#) [SCM1293A-04SO](#)
[ESD200-B1-CSP0201 E6327](#) [SM12-7](#) [CEN955 W/DATA](#) [VESD12A1A-HD1-GS08](#) [CPDQC5V0-HF](#) [D1213A-01LP4-7B](#) [ESD101-B1-02EL](#)
[E6327](#) [AOZ8808DI-03](#) [5KP15A](#) [5KP48A](#) [5KP90A](#) [ESD3V3D7-TP](#) [15KPA36A-LF](#) [P4KE56CA](#) [P4KE68A](#) [P4KE91CATR](#) [P6KE120A](#)
[P6KE13CA](#) [P6KE43CA](#) [P6KE6.8CA](#) [P6KE8.2](#) [P6SMBJ20CA](#) [JANTX1N6072A](#) [SR2835ESKG](#) [SA90CA](#)