

## Description

The CM4407 is the P-Channel enhancement mode power field effect transistors with high cell density, trench technology. This high density process and design have been optimized switching performance and especially tailored to minimize on-state resistance.

## Features

- $V_{DS}$ : -30V
- $I_D$ : -12.3A
- $R_{DS(on)}$  (@ $V_{GS}=-20V$ ): < 11m $\Omega$
- $R_{DS(on)}$  (@ $V_{GS}=-10V$ ): < 12.5m $\Omega$
- $R_{DS(on)}$  (@ $V_{GS}=-4.5V$ ): < 25m $\Omega$
- High density cell design for extremely low  $R_{DS(on)}$
- Excellent on-resistance and DC current capability

## Equivalent Circuit and Pin Configuration

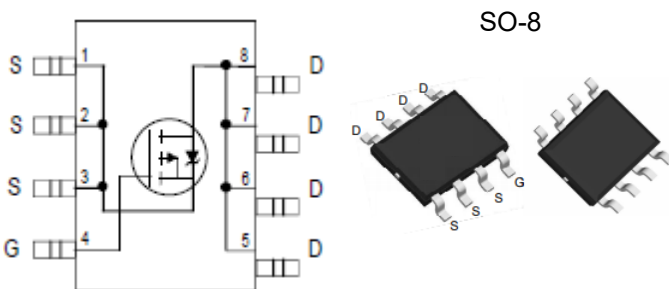

## Applications

- Cellular Handsets and Accessories
- Personal Digital Assistants
- Portable Instrumentation
- Load switch

## Marking Information

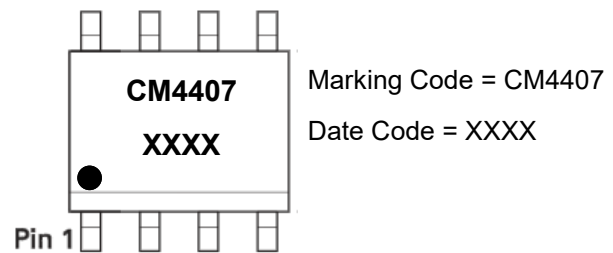

## Ordering Information

Part Number	Packaging	Reel Size
CM4407	2500/Tape & Reel	13 inch

## Absolute Maximum Ratings (TA=25 °C unless otherwise noted)

Parameter	Symbol	Maximum	Unit	
Drain-source Voltage	$V_{DS}$	-30	V	
Gate-source Voltage	$V_{GS}$	$\pm 25$	V	
Continuous Drain Current	$I_D$	TA=25°C	-12.3	A
		TA=70°C	-10.8	A
Pulsed Drain Current <sup>(1)</sup>	$I_{DM}$	-48.2	A	
Total Power Dissipation @ TA=25°C <sup>(2)</sup>	$P_D$	2.5	W	
Thermal Resistance Junction-to-Ambient <sup>(2)</sup>	$R_{\theta JA}$	50	°C/W	
Junction and Storage Temperature Range	$T_J, T_{STG}$	-55 to +150	°C	

**Electrical Characteristics (T<sub>J</sub>=25 °C unless otherwise noted)**

Parameter	Symbol	Conditions	Min	Typ	Max	Units
<b>Static Parameter</b>						
Drain-Source Breakdown Voltage	BV <sub>DSS</sub>	V <sub>GS</sub> =0V, I <sub>D</sub> =-250μA	-30			V
Zero Gate Voltage Drain Current	I <sub>DSS</sub>	V <sub>DS</sub> =-30V, V <sub>GS</sub> =0V, T <sub>C</sub> =25°C			-1	μA
Gate-Body Leakage Current	I <sub>GSS</sub>	V <sub>GS</sub> =±25V, V <sub>DS</sub> =0V			±100	nA
Gate Threshold Voltage	V <sub>GS(th)</sub>	V <sub>DS</sub> =V <sub>GS</sub> , I <sub>D</sub> =-250μA	-1.0		-3.0	V
Static Drain-Source on-Resistance	R <sub>DS(on)</sub>	V <sub>GS</sub> =-20V, I <sub>D</sub> =-12A		9	11	mΩ
		V <sub>GS</sub> =-10V, I <sub>D</sub> =-12A		10.2	12.5	
		V <sub>GS</sub> =-4.5V, I <sub>D</sub> =-10A		16	25	
Diode Forward Voltage	V <sub>SD</sub>	I <sub>S</sub> =-12.3A, V <sub>GS</sub> =0V		-0.8	-1.2	V
Maximum Body-Diode Continuous Current	I <sub>S</sub>				-12.3	A
<b>Dynamic Parameters</b>						
Input Capacitance	C <sub>iss</sub>	V <sub>DS</sub> =-15V, V <sub>GS</sub> =0V, f=1MHz		2060		pF
Output Capacitance	C <sub>oss</sub>			290		
Reverse Transfer Capacitance	C <sub>rss</sub>			245		
<b>Switching Parameters</b>						
Total Gate Charge	Q <sub>g</sub>	V <sub>GS</sub> =-10V, V <sub>DS</sub> =-15V, I <sub>D</sub> =-12A		29.8		nC
Gate Source Charge	Q <sub>gs</sub>			4.7		
Gate Drain Charge	Q <sub>gd</sub>			10		
Turn-on Delay Time	t <sub>D(on)</sub>	V <sub>GS</sub> =-10V, V <sub>DD</sub> =-15V, I <sub>D</sub> =-1A, R <sub>GEN</sub> =2.5Ω		14		ns
Turn-on Rise Time	t <sub>r</sub>			12		
Turn-off Delay Time	t <sub>D(off)</sub>			26		
Turn-off Fall Time	t <sub>f</sub>			10		

Noted: (1) Pulse Test: Pulse Width ≤ 300μs, Duty cycle ≤ 2%.

(2) Device mounted on FR-4 PCB, 1 inch x 0.85 inch x 0.062 inch with 2oz. Copper, t ≤ 10s.

**Typical Performance Characteristics**

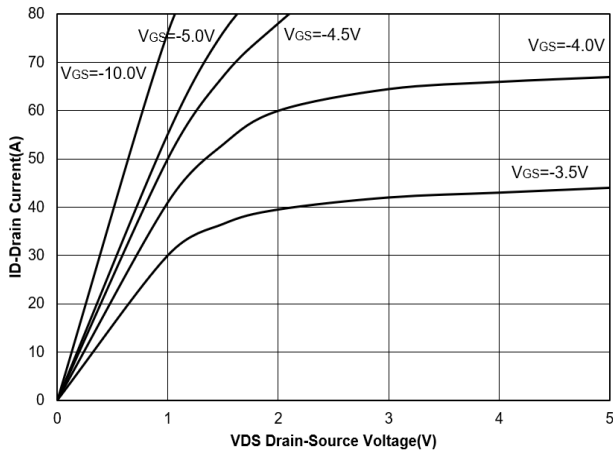

Figure 1. Output Characteristics

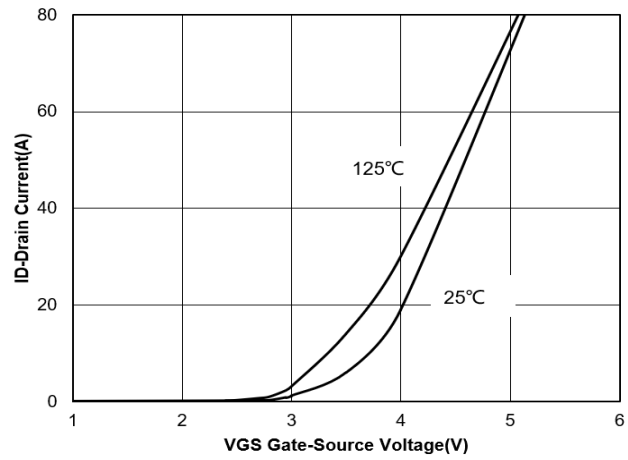

Figure 2. Transfer Characteristics

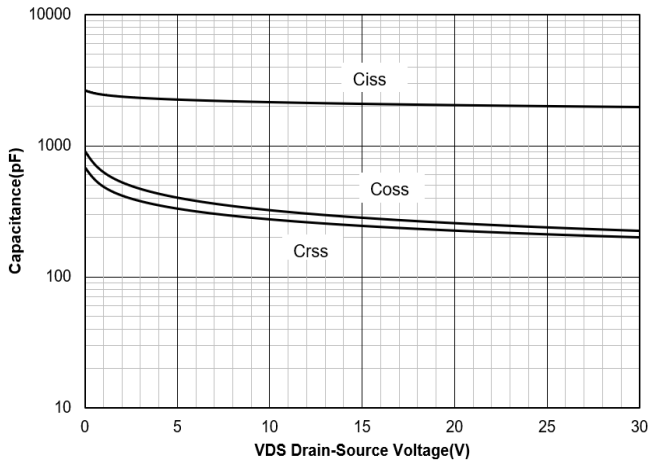

Figure 3. Capacitance Characteristics

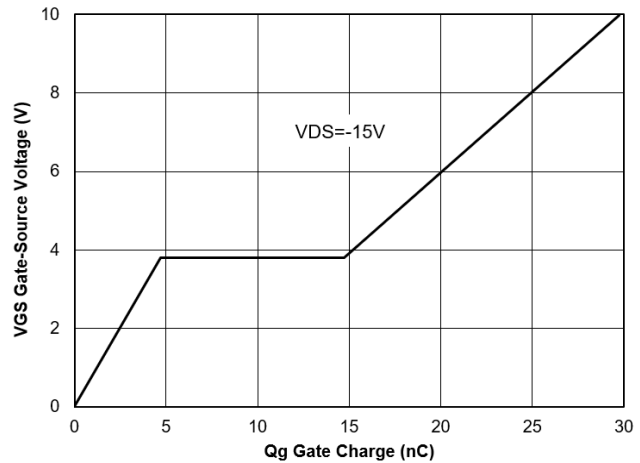

Figure 4. Gate Charge

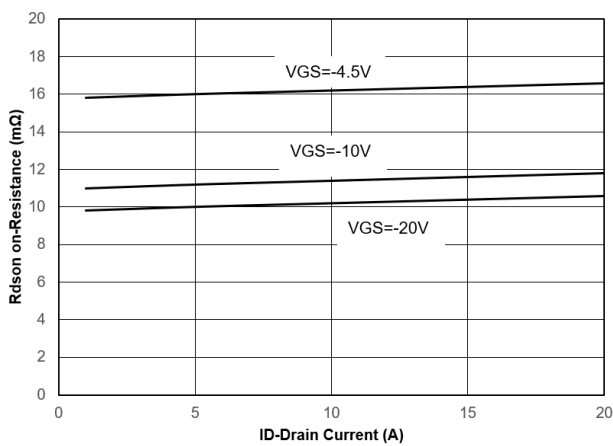

Figure 5. Drain-Source on Resistance

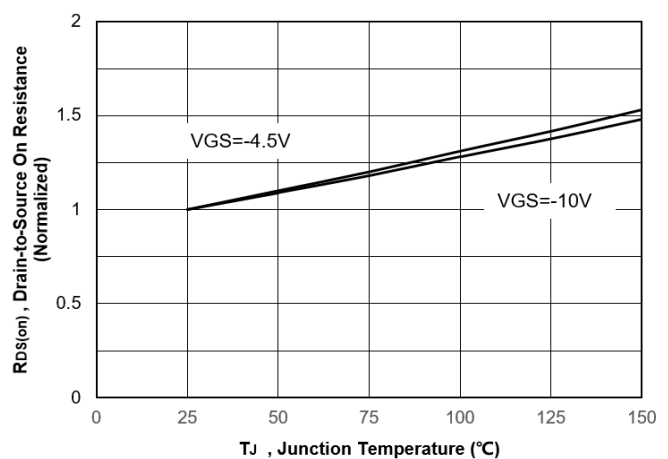

Figure 6. Normalized On-Resistance Vs. Temperature

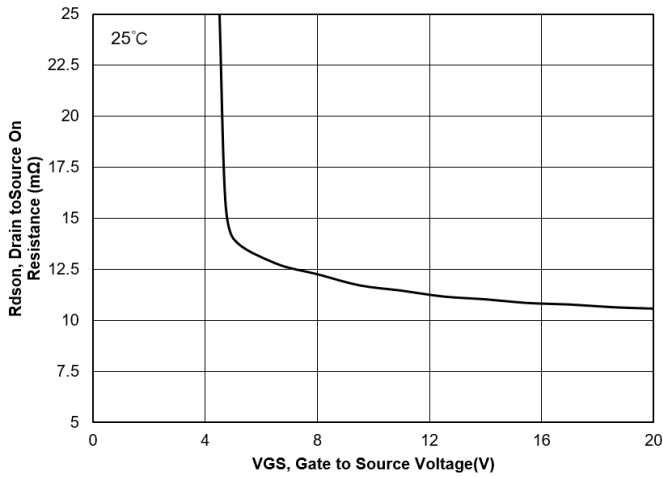

Figure 7. Typical Drain to Source ON Resistance VS Gate Voltage and Drain Current

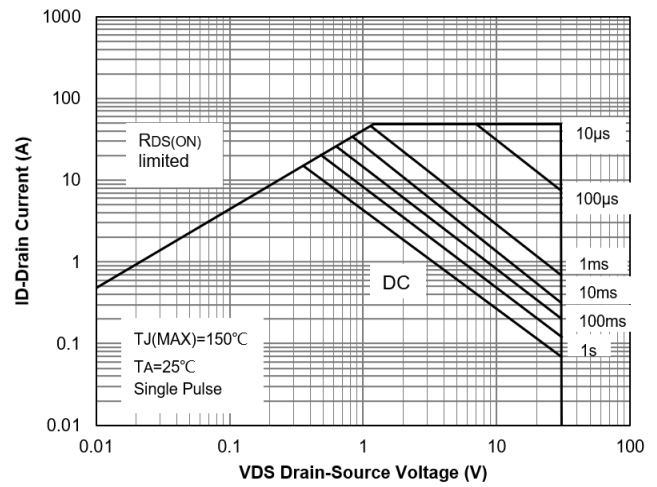

Figure 8. Safe Operation Area

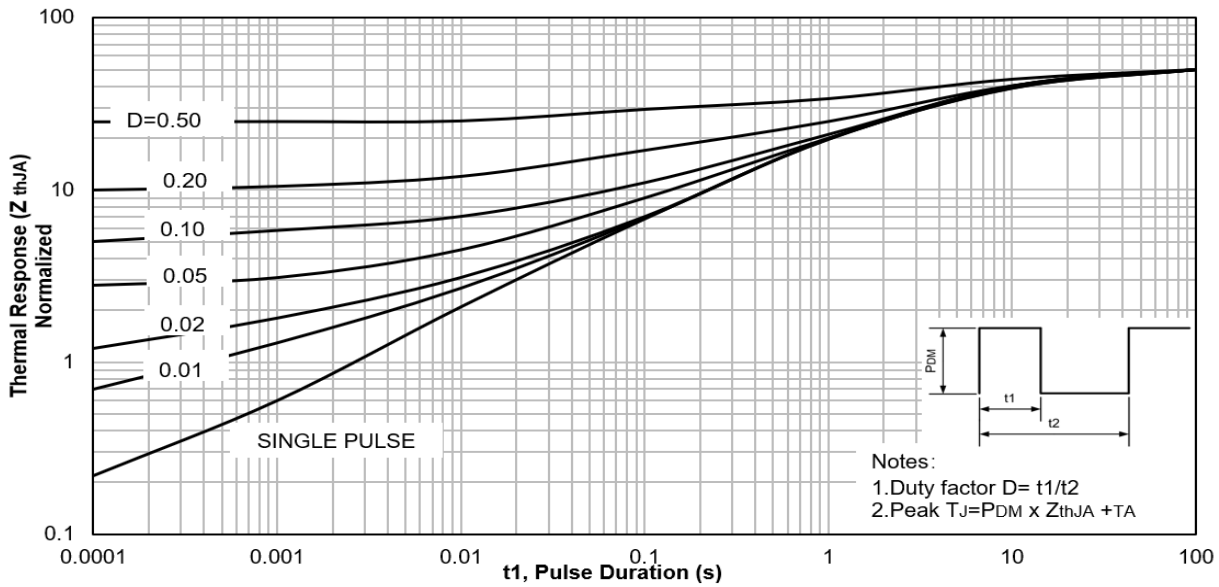

Figure 9. Maximum Effective Transient Thermal Impedance, Junction-to-Ambient

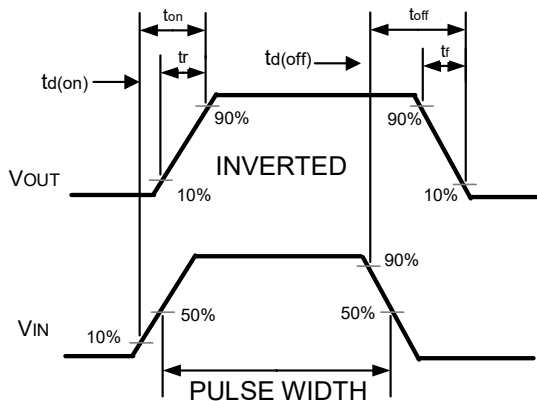
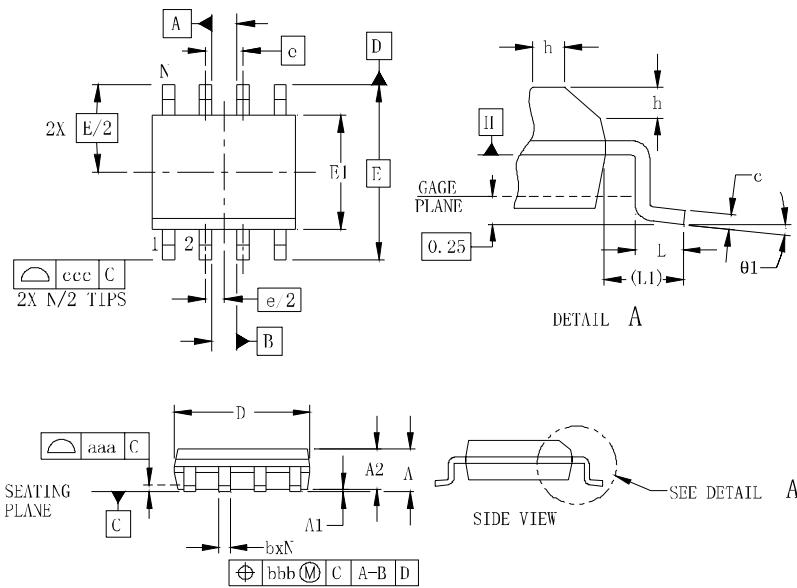

Figure 10. Switching wave

### SO-8 Package Outline Drawing



SYM	DIMENSIONS					
	MILLIMETERS			INCHES		
	MIN	NOM	MAX	MIN	NOM	MAX
A	1.35		1.75	0.053		0.069
A1	0.10		0.25	0.004		0.010
A2	1.25		1.65	0.049		0.065
b	0.31		0.51	0.012		0.020
c	0.17		0.25	0.007		0.010
D	4.80	4.90	5.00	0.189	0.193	0.197
E1	3.80	3.90	4.00	0.150	0.154	0.157
E	6.00 BSC			0.236 BSC		
e	1.27 BSC			0.050 BSC		
h	0.25		0.50	0.010		0.020
L	0.40	0.72	1.04	0.016	0.028	0.041
L1	(1.04)			(0.041)		
N	8			8		
theta 1	0°		8°	0°		8°
aaa	0.10			0.004		
bbb	0.25			0.010		
ccc	0.20			0.008		

### Suggested Land Pattern

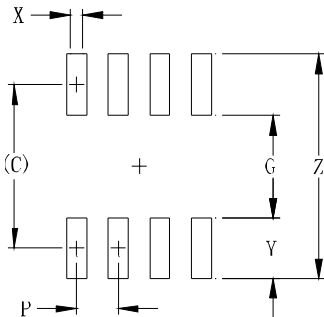

SYM	DIMENSIONS	
	MILLIMETERS	INCHES
C	5.20	0.205
G	3.00	0.118
P	1.27	0.050
X	0.60	0.024
Y	2.20	0.087
Z	7.40	0.291

## X-ON Electronics

Largest Supplier of Electrical and Electronic Components

*Click to view similar products for [MOSFET](#) category:*

*Click to view products by [Applied Power](#) manufacturer:*

Other Similar products are found below :

[614233C](#) [648584F](#) [MCH3443-TL-E](#) [MCH6422-TL-E](#) [NTNS3A92PZT5G](#) [IRFD120](#) [IRFF430](#) [JANTX2N5237](#) [2N7000](#) [AOD464](#)  
[2SK2267\(Q\)](#) [2SK2545\(Q,T\)](#) [405094E](#) [423220D](#) [MIC4420CM-TR](#) [VN1206L](#) [614234A](#) [715780A](#) [SSM6J414TU,LF\(T](#) [751625C](#)  
[IPS70R2K0CEAKMA1](#) [BSF024N03LT3 G](#) [PSMN4R2-30MLD](#) [TK31J60W5,S1VQ\(O](#) [2SK2614\(TE16L1,Q\)](#) [DMN1017UCP3-7](#)  
[EFC2J004NUZTDG](#) [FCAB21350L1](#) [P85W28HP2F-7071](#) [DMN1053UCP4-7](#) [NTE2384](#) [NTE2969](#) [NTE6400A](#) [DMC2700UDMQ-7](#)  
[DMN2080UCB4-7](#) [DMN61D9UWQ-13](#) [US6M2GTR](#) [DMN31D5UDJ-7](#) [SSM6P54TU,LF](#) [DMP22D4UFO-7B](#) [IPS60R3K4CEAKMA1](#)  
[DMN1006UCA6-7](#) [DMN16M9UCA6-7](#) [STF5N65M6](#) [IRF40H233XTMA1](#) [IPSA70R950CEAKMA1](#) [IPSA70R2K0CEAKMA1](#) [STU5N65M6](#)  
[C3M0021120D](#) [DMN6022SSD-13](#)