

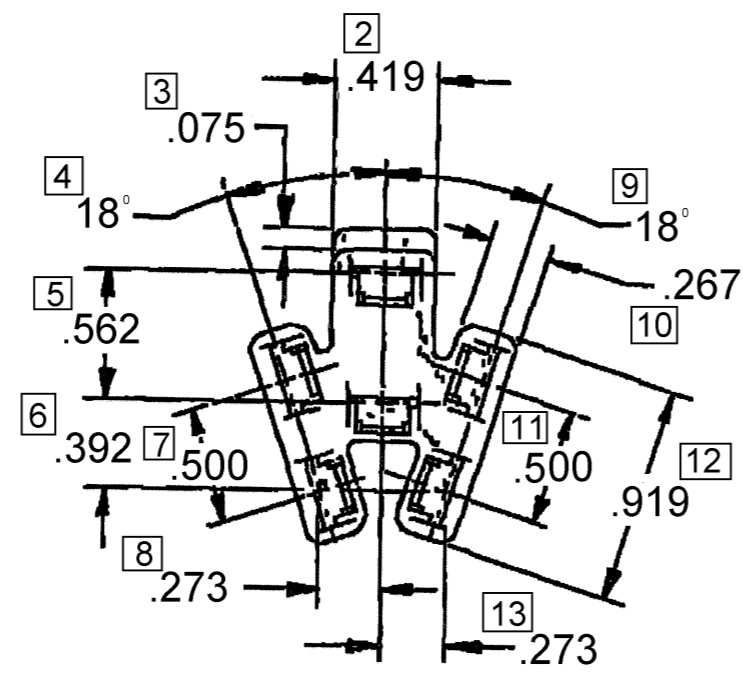

SYMBOL DEFINITION		MISSING NUMBERS		DWG STATUS					ZONE	REVISION HISTORY				AUTH	DR	APVD1	APVD2	
		TOTAL NO. OF SYMBOLS ON DRAWING	13	DATE	STG	REV	N/P	CHG										
A DIMENSION WITHOUT AN INSPECTION REPORT SYMBOL  DOES NOT REQUIRE INSPECTION. IT MAY BE CONTROLLED ON AN INDIVIDUAL COMPONENT DRAWING.		LAST NO. USED	13	29MY62	R	A	-	-			OUTLINE DWG ISSUED TO SUPPLEMENT "D" SIZE DETAIL DWG				3152			
				25JL62	R	B	-	-			2984017 WAS EX-42693 - 2 PLACES				8836			
				30N062	R	C	-	-			BOSS ADDED				10332			
				05DE00	R	C1	-	-			UPDATED PDM ATTRIBUTES				205049			
				19AU04	R	04	-	-			MAT'L SPEC WAS R-67550 AND REVISED NOTES				257190	TLD	TLD	ET

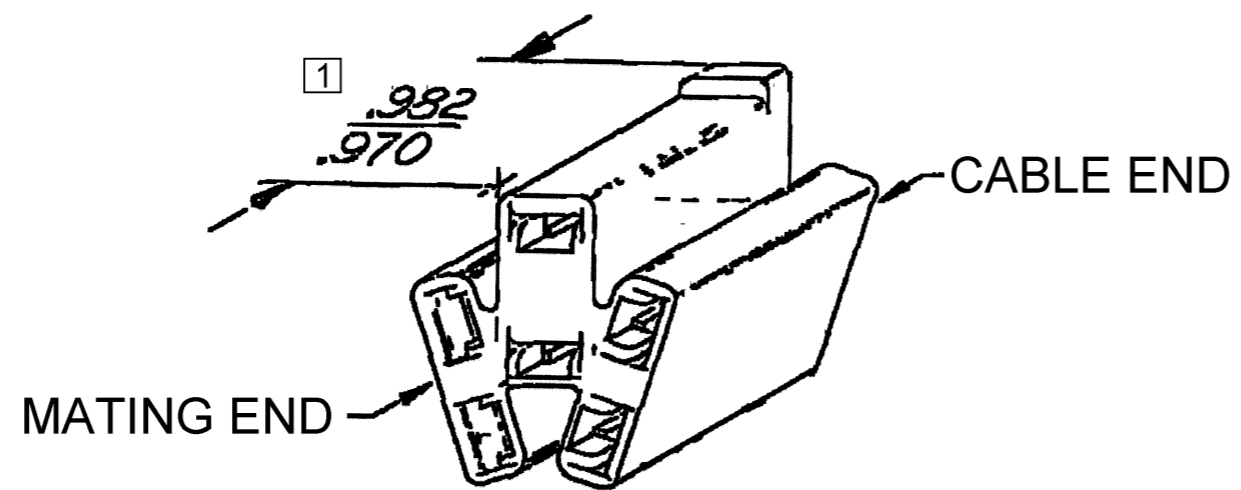

MATING END

NOTES

- UNLESS OTHERWISE SPECIFIED AND/OR INDICATED: DIMENSIONS ARE TO FACE OF VIEW SHOWN AND AUTOMATICALLY ROUNDED BY COMPUTER FOR INSPECTION (SEE MATH MODEL FOR PRECISE DIMENSIONS). FOR ALL OTHER DIMENSIONS NOT SHOWN BUT REQUIRED FOR TOOL BUILD, SEE MATH MODEL FOR PRECISE TOOL PATH DATA.
- MATERIAL RECYCLING CODE PER SAE J1344. (.08)X(.004) RAISED CHARACTERS AS SHOWN TO BE LOCATED ON ANY EXTERIOR SURFACE. OPTIONAL CONSTRUCTION TO BE NO MATERIAL RECYCLING CODE.
- (.08)X(.004) RAISED DELPHI CORPORATE BRAND TO BE LOCATED ON ANY EXTERIOR SURFACE, PREFERABLY VISIBLE AT FINAL ASSEMBLY. OPTIONAL CONSTRUCTION TO BE "PED" OR NO LOGO.

 PROCESS SENSITIVE DIMENSION

DIMENSIONS ENCLOSED IN () INDICATE REFERENCE DIMENSIONS AND NO TOLERANCE LIMITS ARE ESTABLISHED

TOLERANCE UNLESS OTHERWISE SPECIFIED

DECIMAL ±.005
FRACTIONAL
ANGULAR ±2°

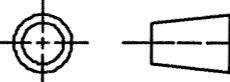
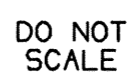
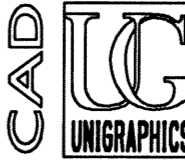
DWG TYPE		PART DRAWING	
STYLE			
VOLUME (CM ³)	DISTR CODE		
	D		
UNLESS OTHERWISE SPECIFIED			
THIS DOCUMENT IS IN ACCORDANCE WITH ASME Y14.5M-1994 AS AMENDED BY THE GM GLOBAL DIMENSIONING AND TOLERANCING ADDENDUM-2001. SEPARATE PATTERNS OF FEATURES MAY BE GAGED SEPARATELY REGARDLESS OF DATUM REFERENCES.			
ALL DIMENSIONS ARE IN INCHES			
REFERENCE		THIRD ANGLE PROJECTION	DO NOT SCALE
			
		USE MATH DATA	

DELPHI			
DELPHI PACKARD ELECTRIC SYSTEMS WARREN, OH			
DR			DATE
APVD1	K. COPE		31MY62
APVD2	LISH		31MY62
APVD3	SGL		31MY62
APVD4			
APVD5			
SUBSTANCES OF CONCERN AND RECYCLED CONTENT PER DELPHI 10949001			
MATERIAL M2097001 PP 1M BLK			
DRAWING NAME CONN 6 F 56 BLK			
DRAWING NUMBER 02984017			
SIZE	SCALE	FRAME NO	SHEET NO
A2	NONE	1 OF 1	1 OF 1
STG	REV	N/P	
R	04	-	

User: GZ7V54 Part: 02984017-CUS01-S01 Date: 19-Aug-04 Time: 11:30 Message: "

X-ON Electronics

Largest Supplier of Electrical and Electronic Components

Click to view similar products for [Automotive Connectors](#) category:

Click to view products by [APTIV](#) manufacturer:

Other Similar products are found below :

[003-018-000](#) [60403001](#) [60993906-B](#) [629515004020001](#) [M902-2131](#) [M902-2161](#) [72.330.1035.1](#) [73.353.4028.0](#) [F119300-B](#) [F166900](#)
[F258300-B](#) [F358300-B](#) [F407400](#) [F444110](#) [F487000](#) [F509500B-B](#) [827153-1](#) [8N1515-32-24P](#) [9-1326729-8](#) [925474-1](#) [928905-1](#) [964562-4](#)
[968782-1](#) [GT17SA-8DS-HU](#) [98891-1012](#) [98947-1016](#) [12004475-L](#) [12010290](#) [12010309-B](#) [12015454](#) [12020219-B](#) [12020308](#) [12041318-B](#)
[12052225-L](#) [12052466](#) [12059125](#) [12064869](#) [12004327-B](#) [12010503-B](#) [12015308](#) [12015384](#) [12015909](#) [1-21030-1](#) [12041254](#) [12041318](#)
[12047946-B](#) [12047957](#) [12047957-L](#) [12059473](#) [12066261](#)