

ITEM	DESCRIZIONE (DESCRIPTION)	MATERIALE (MATERIAL)	COLORE (COLOR)
1	LEVA (LEVER)	PA6.6 GF30%	NERO (BLACK)
2	CORAZZA (SHELL)	PA6.6 GF15%	VEDI TABELLA (SEE TABLE)

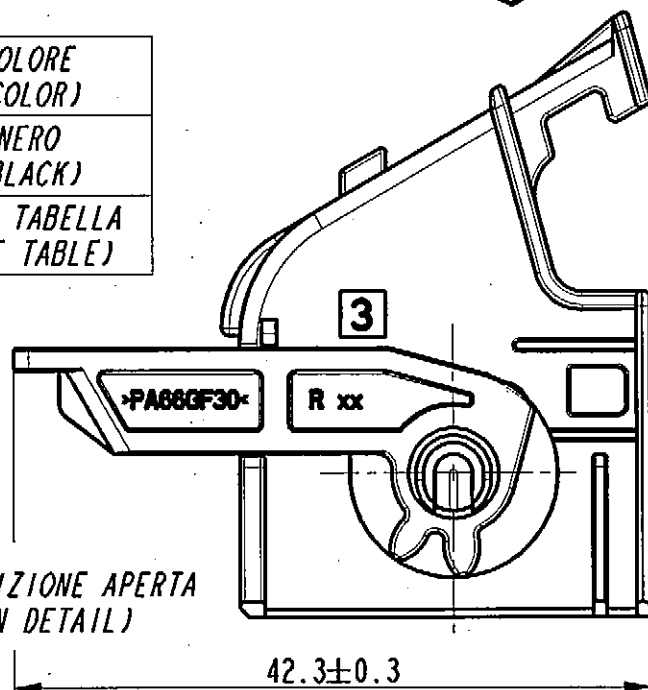

DETTAGLIO POSIZIONE APERTA (OPEN POSITION DETAIL)

**CHIAVI DI POLARIZZAZIONE CORAZZA/LEVA (COVER/LEVER CODING DEFINITION)**

**STRICTLY CONFIDENTIAL**

COMPONENTI	CODE
CORAZZA VERDE	17284050
LEVA NERO	
MODULO BLU	
MODULO BIANCO	

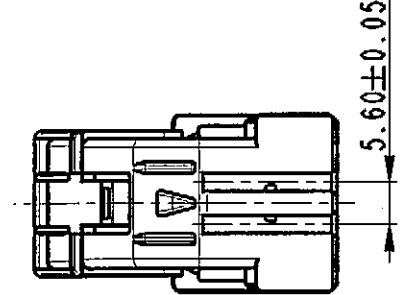
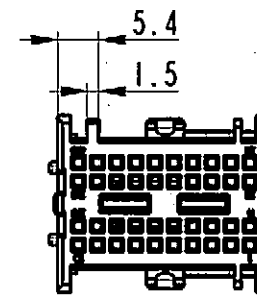

COMPONENTI	CODE
CORAZZA GRIGIO	17284080
LEVA NERO	
MODULO NERO	
MODULO GRIGIO	

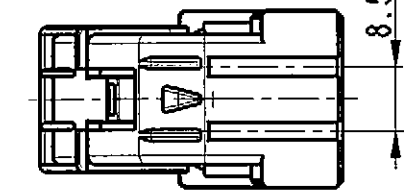
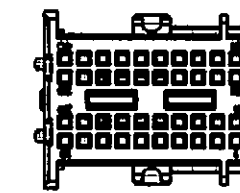

COMPONENTI	CODE
CORAZZA VIOLA	17284070
LEVA NERO	
MODULO NERO	
MODULO GRIGIO	

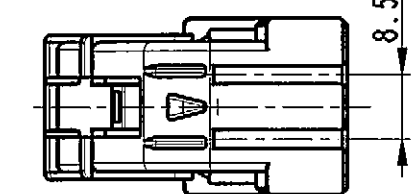
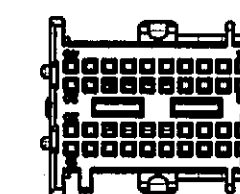

ECN-NO. / NUMERO - ECH	DATE / DATA	REVISION / REVISIONE	POSITION / POSIZIONE	CHANGE DESCRIPTION / DESCRIZIONE MODIFICA	DRAWN BY / DISEGNATORE	CHK. BY / CONTROLLATO	APPR. BY / APPROVATO
09/06	27/01/06	05		Added P/N 17284070 and updated title box			
25/04	27/04/04	04		Released for production			D.T. G.S.
-	02/02/04	03		Aggiunto nota			D.T. G.S.
-	6/11/03	02		Modificato colori, aggiunto tolleranza a dim. max			D.T. G.S.
-	8/8/03	01		Aggiornato secondo modelli			D.T. G.S.

PRODUCT SPEC. / SPEC. DI PRODOTTO: IPS 271  
 PACKAGING SPEC. / SPEC. DI IMBALLAGGIO: -  
 APPLICATION SPEC. / SPEC. DI APPLICAZIONE: -  
 THIS DRAWING AND ALL OTHER INFORMATION CONTAINED THEREIN IS PROPRIETARY AND THE PROPERTY OF FCI. This drawing may not be copied, reproduced or disclosed to any third party without the expressed written permission of FCI. © FCI April 1999  
 QUESTO DISEGNO ED OGNI ALTRA INFORMAZIONE IN ESSO CONTENUTA SONO ESCLUSIVI E DI PROPRIETA' DELLA FCI. Questo disegno non puo' essere copiato, riprodotto o divulgato a terzi senza l'espresso consenso scritto della FCI. © FCI April 1999

TOLERANCES / TOLLERANZE: ±0.3mm / ±P	MATERIAL: see table	SURFACE FINISH / FINITURA SUPERFICIALE: -		ISO PROJECTION / PROIEZIONE ISO: pro / eng.
COUNTERPART Nr. / CONTROPARTE Nr.: -	COLOUR: see table	TOOL NO.: -		DWG SIZE / FORMATO: A3
DO NOT SCALE DRAWING / DISEGNO FUORI SCALA	LOC. CODE / NAZIONALITA': IT	DRAWING NUMBER / NUMERO DISEGNO: FSC 309726		SHEET / FOGLIO: 1 di 2
DRAWN BY / DISEGNATORE: 22/7/03 G. Stella	TITLE / DESCRIZIONE: CONNESSIONE A 40 VIE PER TERMINALE DUO TWIN 0.64	FILE NAME / NOME FILE: FSC309726		SCALE / SCALA: 2:1
CHECKED BY / CONTROLLATO: 22/7/03 T. Cirillo	ESR NO. / NUMERO ESR: EU-050624	CAT. NO. / NUMERO CAT.: SEE TABLE		
APPROVED BY / APPROVATO: -				

## X-ON Electronics

Largest Supplier of Electrical and Electronic Components

*Click to view similar products for [Automotive Connectors](#) category:*

*Click to view products by [APTIV](#) manufacturer:*

Other Similar products are found below :

[003-018-000](#) [60403001](#) [60993906-B](#) [629515004020001](#) [M902-2131](#) [M902-2161](#) [72.330.1035.1](#) [73.353.4028.0](#) [F119300-B](#) [F166900](#)  
[F258300-B](#) [F358300-B](#) [F407400](#) [F444110](#) [F487000](#) [F509500B-B](#) [827153-1](#) [8N1515-32-24P](#) [9-1326729-8](#) [925474-1](#) [928905-1](#) [964562-4](#)  
[968782-1](#) [GT17SA-8DS-HU](#) [98891-1012](#) [98947-1016](#) [12004475-L](#) [12010290](#) [12010309-B](#) [12015454](#) [12020219-B](#) [12020308](#) [12041318-B](#)  
[12052225-L](#) [12052466](#) [12059125](#) [12064869](#) [12004327-B](#) [12010503-B](#) [12015308](#) [12015384](#) [12015909](#) [1-21030-1](#) [12041254](#) [12041318](#)  
[12047946-B](#) [12047957](#) [12047957-L](#) [12059473](#) [12066261](#)