

**RELEASED FOR PRODUCTION**

DRAWING NUMBER FSA 309026 REVISION A SHEET 1/2 APPROVAL LEVEL  
 NUMERO DISEGNO FSA 309026 REVISIONE A FOGLIO 1/2 LIV. DI APPROVAZIONE  
 DRAWING DISEGNO C

SECTION A-A  
 0-0.9  
 Quota opzionale ammessa

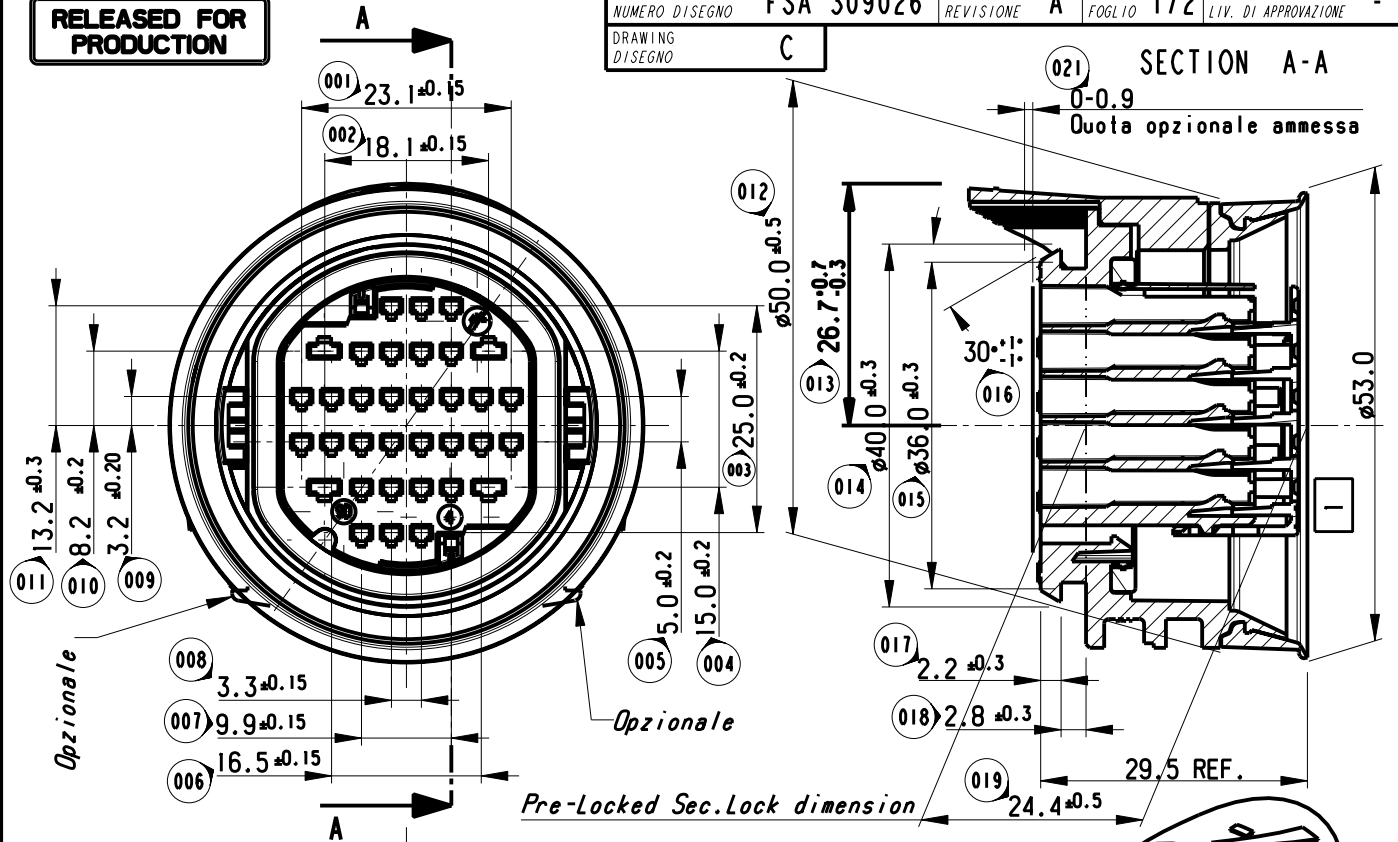

White buffering for DTBFHPE34BS only.

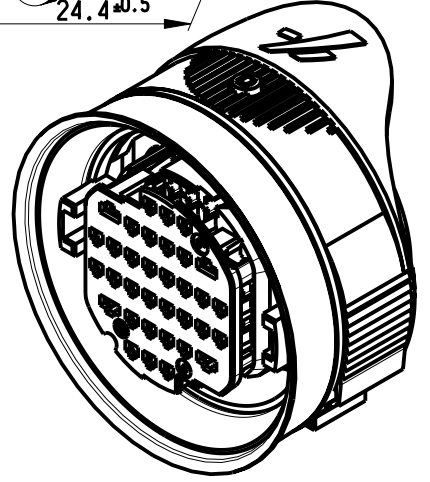
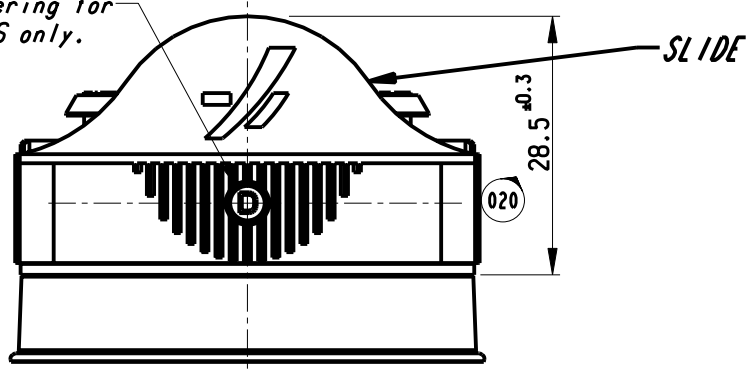

**NOTE 1:**

- The connector is designed for the female contacts : Sicma 2/3 1.5 x 0.8 mm. Sicma 2 2.8 x 0.8 mm.

View " X " Scale 1:1

External gasket maximum clearance after mating male and female holder.

- Completed by the contacts it can be mated with the relative male holder 34 ways : DTBMHPE34BKXXXX DTBMHPE34DGXXXX
- For use and mating operation : see spec. IPS 160

**NOTE 2:**

- The connector can be supplied with different slides. ( View " X " shows the alternative configuration )

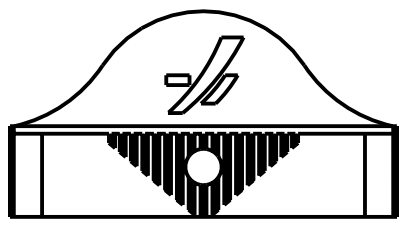

14-07742	30/10/14	A	-	DELPHI P/N ADDED			S.N	F.G	M.C
ECN-NO. NUMERO -ECN	DATE DD/ MM / YY DATA	REVISION REVISIONE	POSITION POSIZIONE	CHANGE DESCRIPTION DESCRIZIONE MODIFICA			DRAWN BY DISEGNATORE	CHK. BY CONTROLLATO	APPR. BY APPROVATO
PRODUCT SPEC. SPEC. DI PRODOTTO	PACKAGING SPEC. SPEC. DI IMBALLAGGIO	APPLICATION SPEC. SPEC. DI APPLICAZIONE	COPYRIGHT DELPHI CORPORATION AND/OR ITS AFFILIATES. ALL RIGHTS RESERVED. REVISED THIS DRAWING IS THE PROPERTY OF DELPHI CORPORATION. THE REPRODUCTION, DISTRIBUTION AND UTILIZATION OF THIS DOCUMENT OR ITS RELATED CAD MATH DATA, AS WELL AS COMMUNICATION OF ANY CONTENT TO OTHERS, WITHOUT EXPRESS AUTHORIZATION IS PROHIBITED.						
TOLERANCES TOLLERANZE		MATERIAL : MATERIALE :	SURFACE FINISH FINITURA SUPERFICIALE		<b>DELPHI</b> DELPHI PACKARD ELECTRICAL/ELECTRONIC ARCHITECTURE TORINO, ITALY		CAD SYSTEM pro / eng.		
COUNTERPART Nr. CONTROPARTE Nr.		COLOUR : COLORE :	TOOL NO.		<b>C</b> ISO PROJECTION PROIEZIONE ISO		DIMENSION IN MILLIMETERS DIMENSIONI IN MILLIMETRI		DWG SIZE FORMATO <b>A4</b>
DO NOT SCALE DRAWING DISEGNO FUORI SCALA			LOC. CODE NAZIONALITA' IT		DRAWING NUMBER NUMERO DISEGNO		SHEET FOGLIO		
DRAWN BY DISEGNATORE	DATE DATA	NAME NOME	TITLE DESCRIZIONE			FSA 309026		1 of 1 di 2	
CHECKED BY CONTROLLATO			DOOR TO BODY 34 WAYS ASSY FEMALE HOLDER						
APPROVED BY APPROVATO			ESR NO. NUMERO ESR	CAT. NO. NUMERO CAT.	SEE SHEET 2 OF 2		SCALE SCALA		

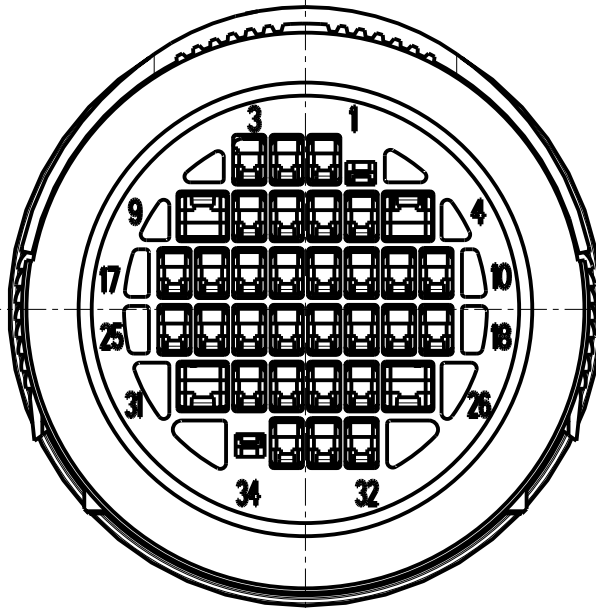

# 34 WAYS



MVL P/N	DELPHI P/N	SLIDE COLOUR
DTBFHPE34BK	15368869	GREY
DTBFHPE34BS	33513314	BLACK

**FEMALE HOLDER CONNECTOR WITH THE ALL CAVITIES OPEN.**

**RELEASED FOR PRODUCTION**

14-07742	30/10/14	A	-	DELPHI P/N ADDED			S.N	F.G	M.C
ECN-NO. NUMERO -ECN	DATE DD / MM / YY DATA	REVISION REVISIONE	POSITION POSIZIONE	CHANGE DESCRIPTION DESCRIZIONE MODIFICA			DRAWN BY DISEGNATORE	CHK. BY CONTROLLATO	APPR. BY APPROVATO
PRODUCT SPEC. SPEC. DI PRODOTTO	PACKAGING SPEC. SPEC. DI IMBALLAGGIO	APPLICATION SPEC. SPEC. DI APPLICAZIONE	COPYRIGHT DELPHI CORPORATION AND/OR ITS AFFILIATES. ALL RIGHTS RESERVED. REVISED THIS DRAWING IS THE PROPERTY OF DELPHI CORPORATION. THE REPRODUCTION, DISTRIBUTION AND UTILIZATION OF THIS DOCUMENT OR ITS RELATED CAD MATH DATA, AS WELL AS COMMUNICATION OF ANY CONTENT TO OTHERS, WITHOUT EXPRESS AUTHORIZATION IS PROHIBITED.						
TOLERANCES TOLLERANZE	MATERIAL : MATERIALE :		SURFACE FINISH FINITURA SUPERFICIALE		<b>DELPHI</b> DELPHI PACKARD ELECTRICAL/ELECTRONIC ARCHITECTURE TORINO, ITALY			CAD SYSTEM	
COUNTERPART Nr. CONTROPARTE Nr.	COLOUR : COLORE :		-						
DO NOT SCALE DRAWING DISEGNO FUORI SCALA	TOOL NO.		LOC. CODE NAZIONALITA'					DIMENSION IN MILLIMETERS DIMENSIONI IN MILLIMETRI <b>A4</b>	
DRAWN BY DISEGNATORE	DATE DATA	NAME NOME	TITLE DESCRIZIONE			DRAWING NUMBER NUMERO DISEGNO			SHEET FOGLIO
CHECKED BY CONTROLLATO	10/11/03		<b>DOOR TO BODY 34 WAYS ASSY FEMALE HOLDER</b>			<b>FSA 309026</b>			2 of 2 di
APPROVED BY APPROVATO									ESR NO. NUMERO ESR

## X-ON Electronics

Largest Supplier of Electrical and Electronic Components

*Click to view similar products for [Automotive Connectors](#) category:*

*Click to view products by [APTIV](#) manufacturer:*

Other Similar products are found below :

[003-018-000](#) [60403001](#) [60993906-B](#) [629515004020001](#) [M902-2131](#) [M902-2161](#) [72.330.1035.1](#) [73.353.4028.0](#) [F119300-B](#) [F166900](#)  
[F258300-B](#) [F358300-B](#) [F407400](#) [F444110](#) [F487000](#) [F509500B-B](#) [827153-1](#) [8N1515-32-24P](#) [9-1326729-8](#) [925474-1](#) [928905-1](#) [964562-4](#)  
[968782-1](#) [GT17SA-8DS-HU](#) [98891-1012](#) [98947-1016](#) [12004475-L](#) [12010290](#) [12010309-B](#) [12015454](#) [12020219-B](#) [12020308](#) [12041318-B](#)  
[12052225-L](#) [12052466](#) [12059125](#) [12064869](#) [12004327-B](#) [12010503-B](#) [12015308](#) [12015384](#) [12015909](#) [1-21030-1](#) [12041254](#) [12041318](#)  
[12047946-B](#) [12047957](#) [12047957-L](#) [12059473](#) [12066261](#)