

FPC-7700

Robust Box PC with Intel® Sandy Bridge / Ivy Bridge Platform



Features

- **Fanless Design**
- Wide Range DC Power Input (9 ~36V)
- Support iAMT Function
- Support Various Video Interfaces (DVI-I + DVI-D)
- Support Optional WiFi or HSUPA Wireless Connectivity
- Rugged Design for Shock/Vibration Protection
- Memory Support up to 16GB (DDR3)
- Intel® SSD compatible

System	
CPU	Support Intel® 2nd & 3rd generation Core™ i7/i5/i3 or Celeron® processors in rPGA988 socket
Memory	2 x 204-pin DDR3 SO-DIMM sockets, supporting 1333/1600MHz SDRAM up to 16GB
Chipset	Intel® QM77
Graphics	Integrated Intel® HD 4000
ATA	2 x Serial ATA ports with RAID 0/1 support 2 x eSATA
LAN Chipset	2 x Intel® WG82583V GbE controllers 1 x Intel® WG82579LM GbE PHY w/ iAMT
Watchdog Timer	1~255 levels reset
I/O	
	1 x DB-44 female connector
Serial Port	COM1/2 are RS-232 COM3/4 are RS-232/422/485 selectable, w/ 2.5kv isolation protection
USB Port	6 x USB 2.0 ports, 4 x USB 3.0/ 2.0 ports
LAN	3 x RJ-45 ports for GbE
Video Port	1 x DVI-I female connector for Digital/ Analog Video output 1 x DVI-D female connector for Digital Video output
Selectable Port	1 x DB25 connector for 1 x DIO (8 in/8 out) port or 1 x LPT port (either one) DIO by default, can be changed to LPT
Audio	Mic-in/Line-out
Expansion Bus	1 x Mini-card slot interconnected with SIM card socket for optional WiFi or HSUPA module 1 x SIM socket/1 x CFAST socket (outside accessible)
Environmental	
Operating Temp.	-20 ~ 55°C (-4 ~ 131°F), ambient w/ air flow
Storage Temp.	-40 ~ 85°C (-40 ~ 185°F)
Operating Humidity	10 ~ 95% @ 55°C (non-condensing)
Vibration	3 Grms/5~500Hz/random operation w/ SSD

Shock	Operating 40G (11ms), Non-operating 60G with SSD Crash 100G, 11ms
--------------	--

Qualification

Certification	CE, FCC Class A
----------------------	-----------------

Power Requirement

Power Input	DC 9~36V input w/ 4-pin terminal block
Power Consumption	3.51A/19V, 67W (i7-3610QE)

Storage

Type	2 x 2.5" drive bays 1 x CFAST socket
-------------	---

Mechanical

Construction	Aluminum alloy
Mounting	Support wall-mounting
Weight	6.4 kg (14.1 lb)
Dimensions (W x D x H)	225 x 267 x 90 mm

OS Support

Windows XP Professional / Windows Embedded Professional 7 / Windows Embedded Standard 7

Ordering Information

FPC-7700	Fanless system w/o expansion
-----------------	------------------------------





» Fanless Design

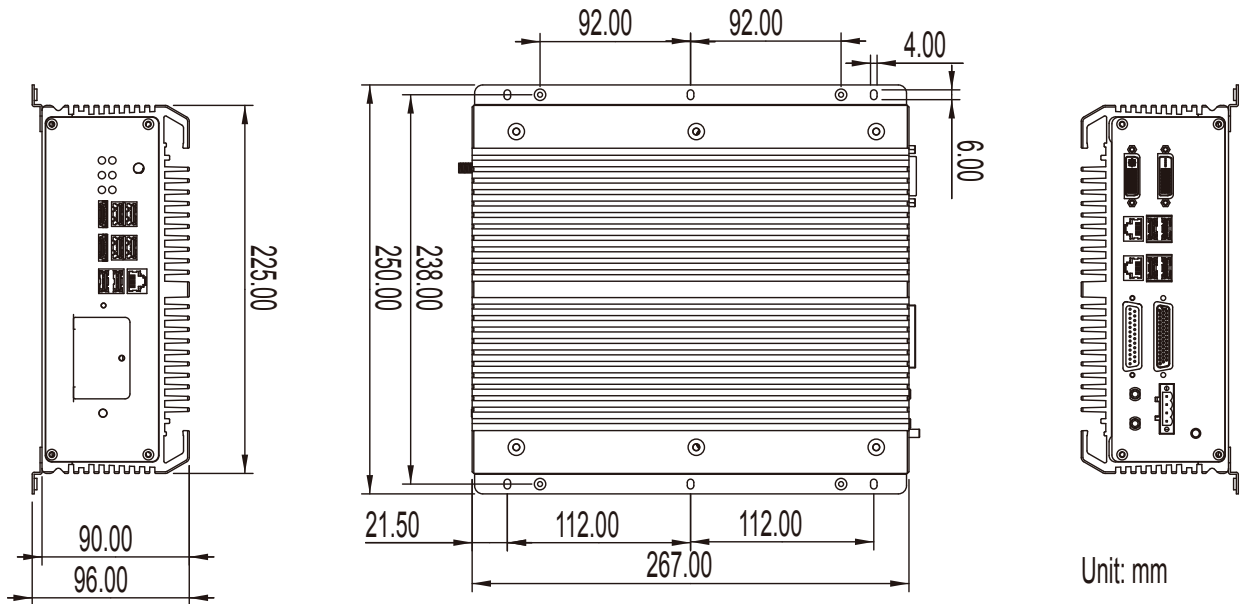





Dimensions



Optional Accessories

PAC-B120W-FSP	19V/6.32A 120W AC/DC adapter kit	
CBL-7100-COM	4 x COM ports converter cable	
WMK-7000	Wall-mount kit for FPC-7XXX Series	

Optional Configuration (CTOS* Kit)

SSD-25040	Intel® 2.5" 40GB SATAII SSD kit	
HSPA-SI1400	HSUPA 3.75G module kit & internal wiring	
WIFI-IN1300	Intel® Centrino® Advanced-N 6205 WiFi module w/ 20cm internal wiring	
ANT-H11	1 x 2dBi HSUPA antenna	
ANT-D11	1 x WiFi Dual-band 2.4G/5G antenna	
Core™ i3-3120ME	Intel® 3rd Gen. Core™ i3-3120ME processor, L2/3M, 2.4G	
Core™ i5-3610ME	Intel® 3rd Gen. Core™ i5-3610ME processor, L2/3M, 2.7G	
Core™ i7-3610QE	Intel® 3rd Gen. Core™ i7-3610QE processor, L2/6M, 2.3G	
MK-3C-4G-1	DDR3-1333 4GB SDRAM DIMM1 kit	
MK-3C-4G-2	DDR3-1333 4GB SDRAM DIMM2 kit	
MK-3C-8G-1	DDR3-1600 8GB SDRAM DIMM1 kit	
MK-3C-8G-2	DDR3-1600 8GB SDRAM DIMM2 kit	

*CTOS means Configure to Order Service.

X-ON Electronics

Largest Supplier of Electrical and Electronic Components

Click to view similar products for [Embedded Box Computers](#) category:

Click to view products by [Arbor Technology](#) manufacturer:

Other Similar products are found below :

[tBOX312-870-FL-i7-DC](#) [tBOX313-835-FL-RJ-DC](#) [UPOS-3150-R0W0E](#) [ARK-20-S8A1E](#) [R2224WTTYSR](#) [BXNUC9i5QNX](#)
[BXNUC9i5QNX1](#) [BKNUC9V7QNX](#) [BKNUC9V7QNX1](#) [2-A0DF-2001](#) [EM3000-3845-8-128-WL-U-1](#) [TANK-870AI-i5/8G/2A-R10](#)
[PRFE21000038](#) [EM5000-I3-8-128-WL-W7-1](#) [EM3000-3845-8-128-WL-W7-1](#) [PRFE21000039](#) [AMOS-825-1Q10A1](#) [UPS-EDAI-X70864-](#)
[U01-DC01](#) [MXE-211/M8G](#) [PXIe-3985/M16G](#) [PXIe-3987/M16G/SSD](#) [ROScube-I, IntelR Core? i7, RQI-57](#) [AIMB-T1215DA-00Y0E](#) [AIMB-](#)
[T1217DW-00Y0E](#) [AIMB-T12315A-00Y0E](#) [AMAX-5580-74000A](#) [AMAX-5580-54000A](#) [AMAX-5580-C3000A](#) [APAX-5580-474AE](#) [ARK-](#)
[6322-Q0A2E](#) [DS-100GF-S8A1E](#) [DS-100GL-S8A1E](#) [EPC-R4680CQ-XAA1E](#) [ESRP-CSS-UNO2484](#) [ITA-1611-10A1E](#) [ITA-1711-10A1E](#)
[MIC-710AI-00A1](#) [UNO-247-J1N1AE](#) [UTX-3115FS-S6A2E](#) [AMI220AF-4L-7500](#) [AMI220AF-4L-7700](#) [ELIT-1200](#) [AIE100-903-FL](#)
[EBOX671-517-FL-DC](#) [MVS900-511-FL](#) [AMS200](#) [CSB200-898-IT](#) [SE-92-I7](#) [SI-606](#) [SI-60E](#)