

2000 Slide Switches - Snap-in & 2 hole fixing 10A 250Vac



- ▶ 2 way 'voltage selector'
- ▶ Ratings up to 10A, 250V ac
- ▶ Snap in and flange mounting
- ▶ PCB & solder terminals
- ▶ 2 and 3 position
- ▶ Choice of circuits
- ▶ Choice of actuators



10 A 250Vac T85
6(3)A 250Vac T85



UL CSA 16A 250Vac Non Inductive
UL CSA 4A 300Vac
UL65°C, file no. E45221, CSA file no. LR10990



RoHS compliant

μ contact gap

Please specify: Standard action (SP116) or light action (SP118).
2000 series lubrication is inorganic and does not degrade plastics.

Technical data on pages 4 & 5.

115/230 is preferred legend

B BLACK
W WHITE
R RED

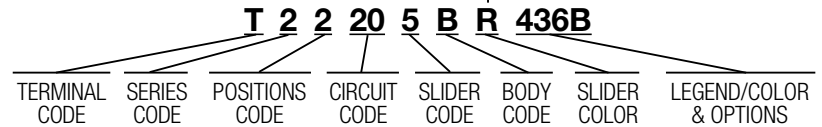

ORDER FORMAT

▶ TERMINAL	▶ SERIES	▶ POS'N	▶ CIRCUIT <small>Viewed from back</small>	▶ SLIDER											
<p>K</p> <p>2.8 x 0.8</p>		2 Switching positions	<p>10</p>	0	6	C	L	S	2	7	D	M	T		
				2	3	8	E	N	4	9	H	P	R		
				3	4	5	A	K	R						
				10	20	30	40								
<p>R</p> <p>2.8 x 0.8</p>		2 Switching positions	<p>10</p>	0	6	C	L	S	2	7	D	M	T		
2				3	8	E	N	4	9	H	P	R			
3				4	5	A	K	R							
10				20	30	40									
<p>T</p> <p>Solder</p>	2	3 Switching positions	<p>10</p>	0	6	C	L	S	2	7	D	M	T		
2				3	8	E	N	4	9	H	P	R			
3				4	5	A	K	R							
10				20	30	40									
<p>X</p> <p>PCB 0.8 Sq. For mounting stability switches have extra "support" terminals</p> <p>* Nominal - Dimension varies with body type. For exact figure call factory</p>		3 Switching positions	<p>10</p>	0	6	C	L	S	2	7	D	M	T		
2				3	8	E	N	4	9	H	P	R			
3				4	5	A	K	R							
10				20	30	40									



T22208E



T22308E



T2230MF



T22205B



T22305B



T23204B

BODY

B With fixing holes

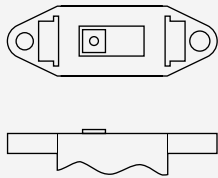

E Snap-in

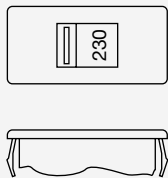

Cut-outs must be punched in the direction of insertion

F Snap-in (single pole ON OFF only)

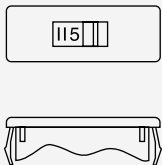

Cut-outs must be punched in the direction of insertion

OPTIONS

Color

For custom slider colors call the factory. A full range is available for large orders

Standard body color is black

Legend printing

2 Frequently requested legends are shown

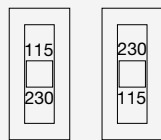

436() 437()

() is legend color
(B) - Black
(W) - White
(R) - Red

Please call the factory for custom legends

DIMENSIONS (mm)

2 Pos B

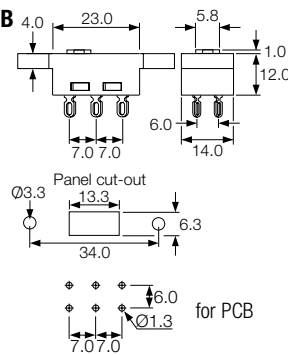

Cut-out / PCB Matrix

3 Pos B

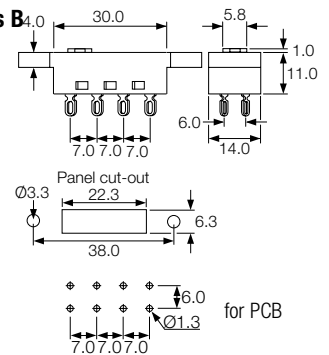

2 Pos E

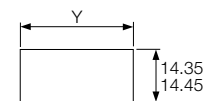
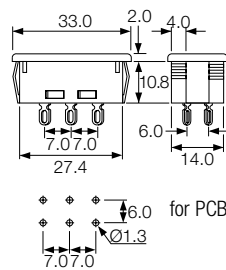

Panel thickness	Dim. Y
0.8-1.2	29.75/29.85
1.63	30.15/30.25
2.0	30.35/30.45
2.5	30.55/30.65

2 Pos F

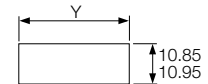
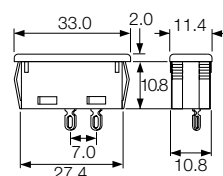

Panel thickness	Dim. Y
0.8-1.2	29.75/29.85
1.63	30.15/30.25
2.0	30.35/30.45
2.5	30.55/30.65

for PCB, call factory for details

X-ON Electronics

Largest Supplier of Electrical and Electronic Components

Click to view similar products for [Slide Switches](#) category:

Click to view products by [Arcoelectric](#) manufacturer:

Other Similar products are found below :

[6-1437581-1](#) [M43R](#) [MHS123K15D](#) [MHSS1104A](#) [MMD](#) [GH49S010001](#) [GH49WW00001](#) [1437576-8](#) [EPS1PC1](#) [1825074-1](#) [1825160-3](#)
[1825167-2](#) [25139NLDB](#) [25436NLDB](#) [25449NAH](#) [25536NA](#) [L101011ML04B](#) [SLB1240R45](#) [SLSA12004](#) [1825078-1](#) [1825080-4](#) [1825081-1](#)
[1825269-1](#) [1825270-2](#) [STS141RA04](#) [T2215BEN506](#) [GF-124-0204](#) [GH46P000001](#) [GH46W000001](#) [GH49P010001](#) [25339NA](#) [25436NLDH](#)
[CST91246FK](#) [TG36P000000](#) [TG36P000050](#) [47227LFE](#) [49331L](#) [MHSS1105A](#) [50208L](#) [HW4S-5LF22N3](#) [L202091MS02Q](#) [4-1437581-7](#)
[X2225CR-437W](#) [48BFSP3M2QT](#) [49329L](#) [1101M1S3ZB8E2](#) [1-1437581-1](#) [EG1218REDACTUATOR](#) [TG39W000000](#) [1825075-1](#)