

## Description

The Arduino Edge Control board is designed to address the needs of precision farming. It provides a low power control system, suitable for irrigation with modular connectivity.

The board is compatible with MKR Boards 2G/3G/CatM1/NB-IoT, LoRa, Sigfox and WiFi/BT connectivity.

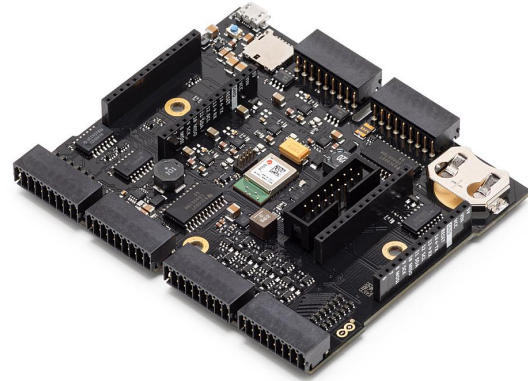

## Target areas:

Agriculture measurements, smart irrigation systems, hydroponics

## Features

- **Nina B306 Module**
  - **Processor**
    - 64 MHz Arm® Cortex-M4F (with FPU)
    - 1 MB Flash + 256 KB RAM
  - **Wireless**
    - Bluetooth (BLE 5 via Cordio stack, BLE 4.2 via Arduino Stack)
    - Advertising Extensions
    - +8 dBm TX power
    - 95 dBm sensitivity
    - 4.8 mA in TX (0 dBm)
    - 4.6 mA in RX (1 Mbps)
  - **Peripherals**
    - Full-speed 12 Mbps USB
    - Arm CryptoCell CC310 security subsystem
    - QSPI/SPI/TWI/I<sup>2</sup>S/PDM/QDEC
    - High speed 32 MHz SPI
    - Quad SPI interface 32 MHz
    - 12-bit 200 ksp ADC
- 128 bit AES/ECB/CCM/AAR co-processor
- **Memory**
  - 1 MB internal Flash memory
  - 2MB onboard QSPI
  - SD Card slot
- **Power**
  - Low Power
  - 200uA Sleep current
  - Can operate for up to 34 months on a 12V/5Ah battery
- **12 V Acid/lead SLA Battery Supply** (Recharged via solar panels)
- **RTC CR2032 Lithium Battery back up**
- **Battery**
  - **LT3652 Solar Panel Battery Charger**



- Input Supply Voltage Regulation Loop for Peak Power Tracking in (MPPT) Solar applications
- **I/O**
  - 6x edge sensitive wake up pins
  - 16x hydrostatic watermark sensor input
  - 8x 0-5V analog inputs
  - 4x 4-20mA inputs
  - 8x latching relay command outputs with drivers
  - 8x latching relay command outputs without drivers
- 4x 60V/2.5A galvanically isolated solid state relays
- 6x 18 pin plug in terminal block connectors
- **Dual MKR Socket**
  - Individual power control
  - Individual Serial Port
  - Individual I2C ports
- **Safety information**
  - Class A

# Contents

<b>1. The board</b>	<b>5</b>
1.1 Application examples	5
1.2 Accessories	5
1.3 Related products	5
<b>2. Specifications</b>	<b>6</b>
2.1 Absolute maximum ratings	6
2.2 Recommended Operating Conditions	6
<b>3. Functional Overview</b>	<b>6</b>
3.1 Board Topology	6
3.2 Processor	8
3.3 5V Analog Sensors	9
3.4 4-20mA sensors	9
3.5 Watermark Sensors	10
3.6 Latching outputs	10
3.7 Solid State Relays	11
3.8 Storage	11
3.9 Power tree	12
3.10 Solution overview	13
<b>4. Board Operation</b>	<b>13</b>
4.1 Getting started - IDE	13
4.2 Getting started - Arduino Web Editor	13
4.3 Getting started - Arduino IoT Cloud	13
4.4 Sample Sketches	14
4.5 Online resources	14
4.6 Board Recovery	14
<b>5. Connector Pinouts</b>	<b>14</b>
5.1 USB	14
5.2 J11 Power/Relay connector	14
5.3 J3 Wake up signals/External relay commands	15
5.4 J7 Analog/4-20mA	15
5.5 J8 Watermark	16
5.6 J9 Latching relay (+/- VBAT)	16
5.7 J10 Latching relay command (0-5)	17
5.8 J1 LCD Connector	18
<b>6. Mechanical Information</b>	<b>19</b>
6.1 Board outline	19
6.2 Mounting holes	19



6.3 Connector Positions	20
<b>7. Certifications</b>	<b>21</b>
7.1 Declaration of Conformity CE DoC (EU)	21
7.2 Declaration of Conformity to EU RoHS & REACH 211 01/19/2021	21
7.3 Conflict Minerals Declaration	22
<b>8. FCC Caution</b>	<b>22</b>
<b>9. Company information</b>	<b>24</b>
<b>10. Reference Documentation</b>	<b>24</b>
<b>11. Revision History</b>	<b>24</b>

# 1. The board

## 1.1 Application examples

The Arduino Edge Control is your gateway to Agriculture 4.0. Get real-time insight into the state of your process and increase crop yield. Improve business efficiency through automation and predictive farming. Tailor the Edge Control to your needs by using up two Arduino MKR Boards and an assortment of compatible Shields. Maintain historical records, automate quality control, implement crop planning and more through the Arduino IoT Cloud from anywhere in the world.

**Automated Greenhouses:** In order to minimise carbon emissions and increase economic yield, it is important to ensure that the best environment is provided for the growth of crops in terms of humidity, temperature and other factors. The Arduino Edge Control is an integrated platform that enables remote monitoring and real-times optimization to this end. Including a Arduino MKR GPS Shield (SKU:ASX00017) allows for optimum crop rotation planning and acquisition of geospatial data.

**Hydroponics/Aquaponics:** Since hydroponics involves the growth of plants without soil, delicate care must be maintained to ensure they maintain the narrow window required for optimum growth. The Arduino Edge Control can ensure that this window is achieved with minimal manual labour. Aquaponics can provide even more benefits than conventional hydroponics towards which the Arduino Edge Control can help match the even higher requirements by providing better control over the internal process while ultimately reducing production risks.

**Mushroom Cultivation:** Mushrooms are notorious for requiring the perfect temperature and humidity conditions to sustain spore growth while also preventing competing fungi from growing. Thanks to the numerous watermark sensors, output ports and connectivity options available on the Arduino Edge Control as well as the Arduino IoT Cloud, this precision farming can be achieved on an unprecedented level.

## 1.2 Accessories

- Irrrometer Tensiometers
- Watermark soil moisture sensors
- Mechanized ball valves
- Solar panel
- 12V/5Ah acid/lead SLA battery (11 - 13.3V)

## 1.3 Related products

- LCD Display + Flat Cable + plastic enclosure
- 1844646 Phoenix contacts (included with the product)
- Arduino MKR family boards (for expanding wireless connectivity)

## 1.4 Solution overview

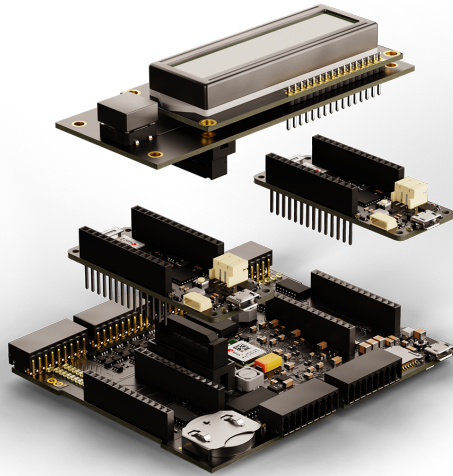

Example of a typical application for a solution including LCD Display and two Arduino MKR 1300 boards.

## 2. Ratings

### 2.1 Absolute maximum ratings

Symbol	Description	Min	Typ	Max	Unit
$T_{Max}$	Maximum thermal limit	-40	20	85	°C
$VBatt_{Max}$	Maximum input voltage from battery input	-0.3	12	17	V
$VSolar_{Max}$	Maximum input voltage from solar panel	-20	18	20	V
$ARelay_{Max}$	Maximum current through relay switch	-	-	2.4	A
$P_{Max}$	Maximum Power Consumption	-	-	5000	mW

### 2.2 Recommended Operating Conditions

Symbol	Description	Min	Typ	Max	Unit
T	Conservative thermal limits	-15	20	60	°C
VBatt	Input voltage from battery input	-	12	-	V
VSolar	Input voltage from solar panel	16	18	20	V

### 3. Functional Overview

#### 3.1 Board Topology

Top View

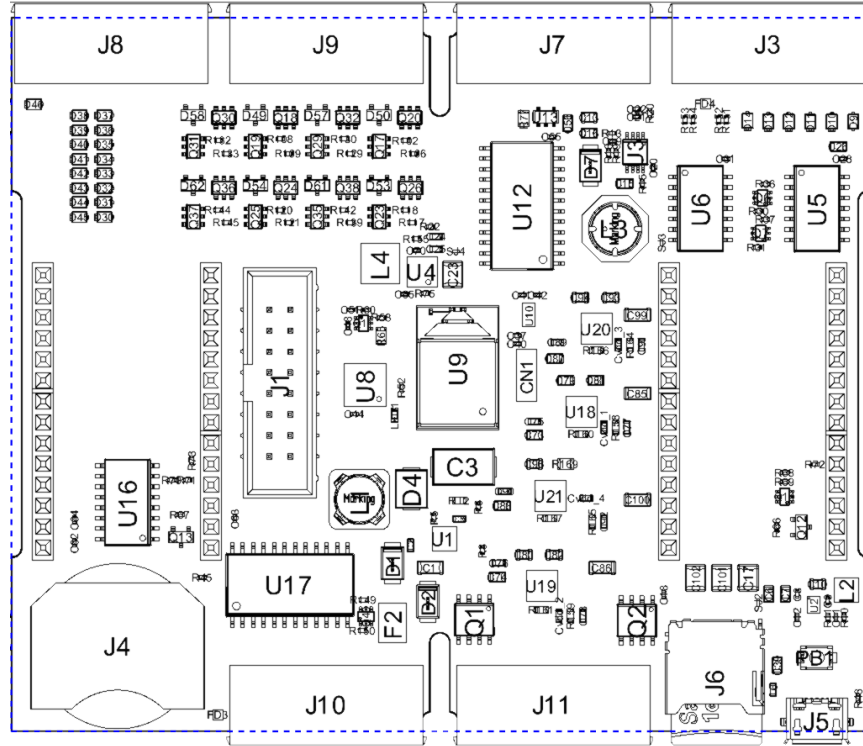

Ref.	Description	Ref.	Description
U1	LT3652HV battery charger IC	PB1	Reset pushbutton
U2	MP2322 3.3V buck converter IC	J1	LCD Module Connector
U3	MP1542 19V boost converter IC	J3,7,9,8,10,11	1844798 pluggable terminal blocks
U4	TPS54620 5V boost converter IC	J6	Micro SD Card
U5	CD4081BNSR AND gate IC	J4	CR2032 battery holder
U6	CD40106BNSR NOT gate IC	J5	Micro USB (NINA Module)
U12,U17	MC14067BDWG multiplexer IC	U8	TCA6424A IO expander IC
U16	CD40109BNSRG4 I/O Expander	U9	NINA-B306 Module
U18,19,20,21	TS13102 solid state relay IC	U10	ADR360AUJZ-R2 Voltage

			reference series 2.048V IC
LED1	On board LED		

### Back View

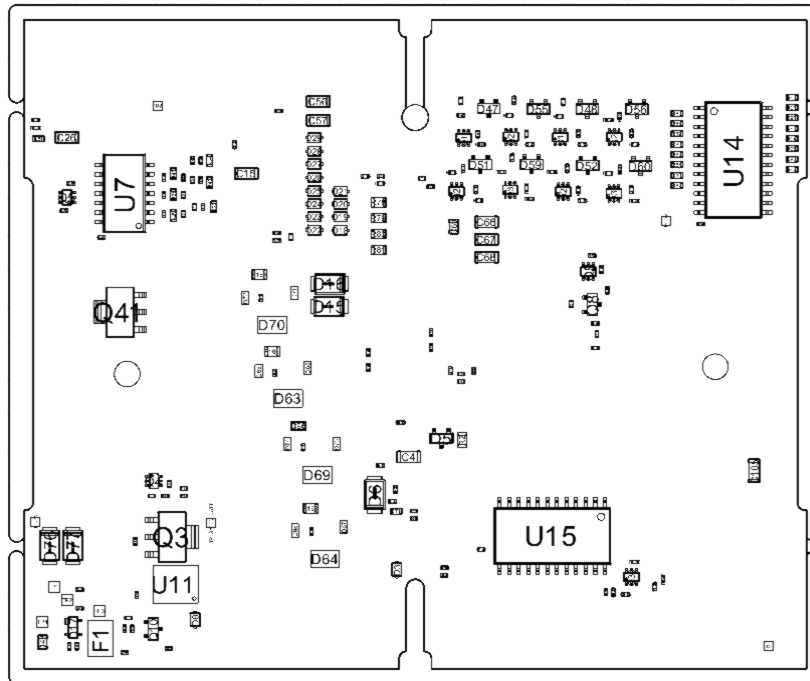

Ref.	Description	Ref.	Description
U11	W25Q16JVZPIQ Flash 16M IC	Q3	ZXMP4A16GTA MOSFET P-CH 40V 6.4A
U7	CD4081BNSR AND gate IC	U14, 15	MC14067BDWG IC MUX

### 3.2 Processor

The Main Processor is a Cortex M4F running at up to 64MHz.

### 3.1 LCD Screen

The Arduino Edge Control provides a dedicated connector (J1) for interfacing with a HD44780 16x2 LCD display module, sold separately. The main processor controls the LCD via a TCA6424 port expander over I2C. Data is transferred over a 4-bit interface. LCD backlight intensity is also adjustable by the main processor.



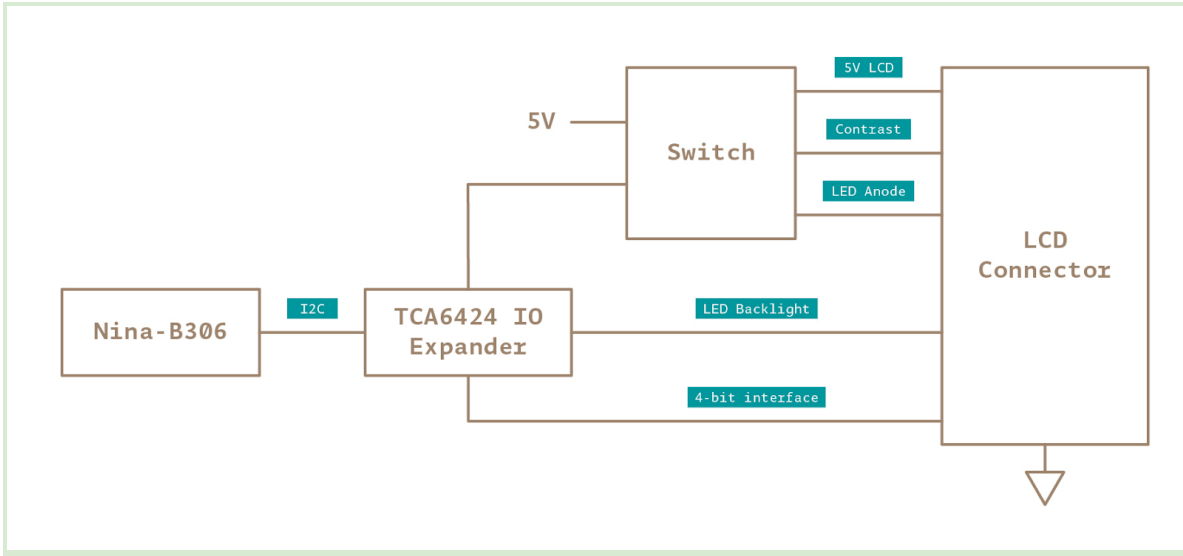

### 3.3 5V Analog Sensors

Up to eight 0-5V analog inputs can be connected to J4 for interfacing analog sensors such as tensiometers and dendrometers. Inputs are protected by a 19V Zener diode. Each input is connected to an analog multiplexer that channels the signal to a single ADC port.

Each input is connected to an analog multiplexer (MC14067) that channels the signal to a single ADC port. The main processor controls the input selection via a TCA6424 port expander over I2C.

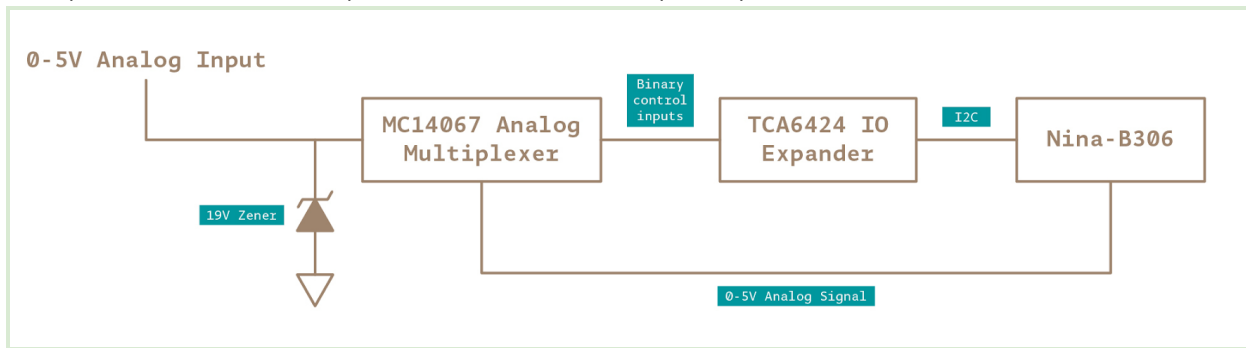

### 3.4 4-20mA sensors

Up to four 4-20mA sensors can be connected to J4. A reference voltage of 19V is generated by the MP1542 step-up converter to power the current loop. The sensor value is read via a 220 ohm resistor.

Each input is connected to an analog multiplexer (MC14067) that channels the signal to a single ADC port. The main processor controls the input selection via a TCA6424 port expander over I2C.

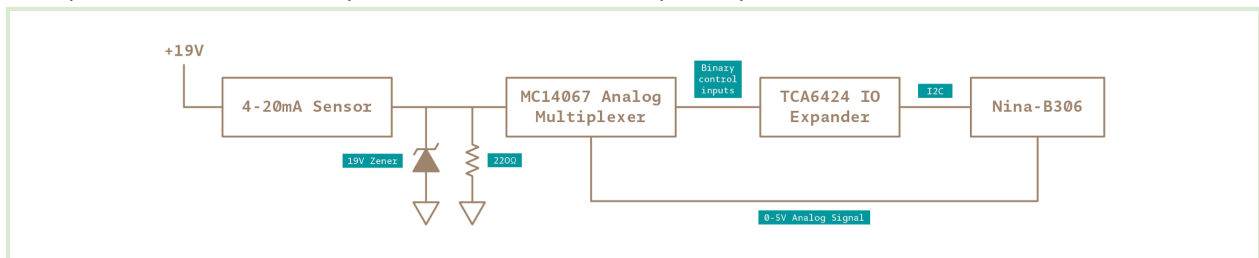

### 3.5 Watermark Sensors

Up to sixteen hydrostatic watermark sensors can be connected to J8. Pins J8-17 and J8-18 are the common sensor pins for all the sensors, controlled directly by the microcontroller. Inputs and the common sensor pins are protected by a 19V Zener diode.

Each input is connected to an analog multiplexer (MC14067) that channels the signal to a single ADC port. The main processor controls the input selection via a TCA6424 port expander over I2C. The board supports 2 precision modes.

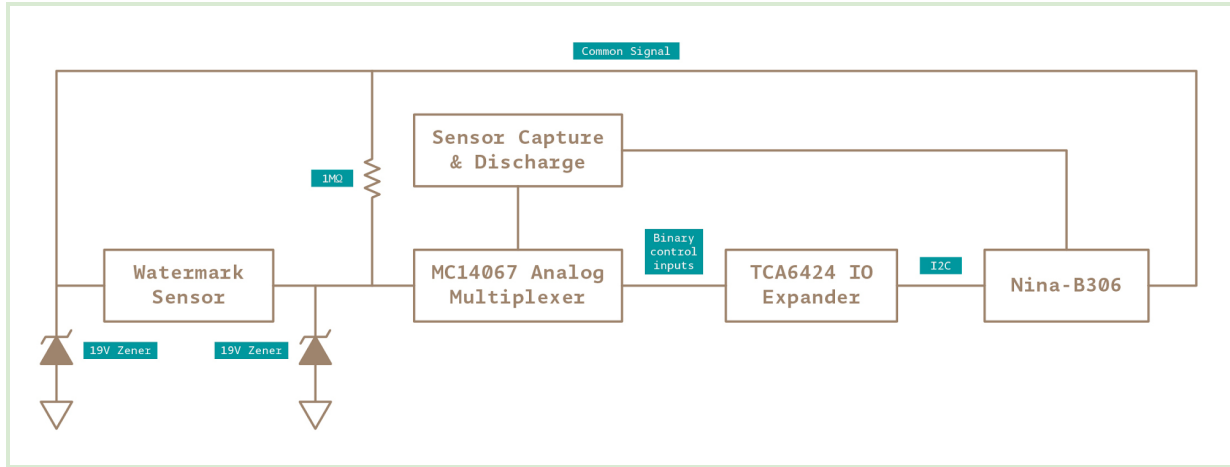

### 3.6 Latching outputs

Connectors J9 and J10 provide outputs to latching devices like motorized valves. The latching output consists of dual channels (P and N) through which an impulse or strobe can be sent in either of the 2 channels (to open a close valve for example). The duration of the strobes can be configured to adjust to the external device requirement.

The board provides a total of 16 latching ports divided in 2 types:

- Latching commands (J10): 8 ports for high impedance inputs ( max +/- 25 mA). Connect to external devices with third-party protection/power circuits. Referenced to VBAT.

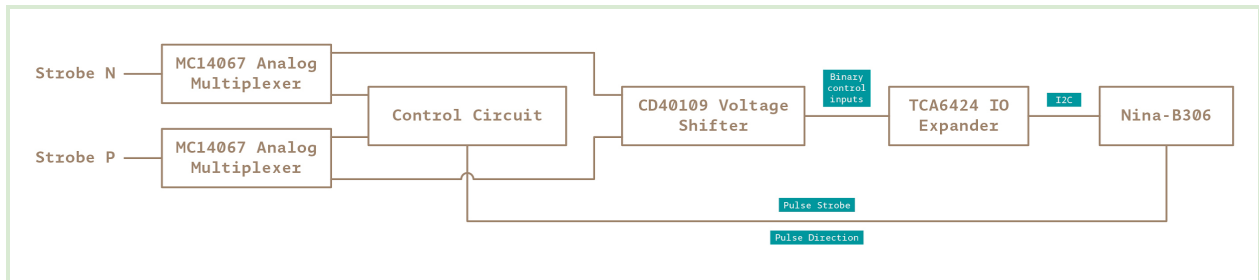

- Latching Out (J9): 8 ports. This outputs includes drivers for the latching device. No external drivers are needed. Referenced to VBAT.

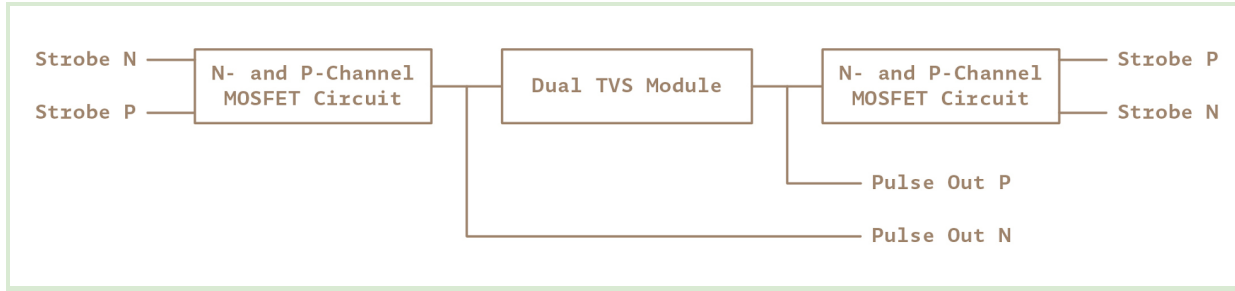

### 3.7 Solid State Relays

The board features four configurable 60V 2.5A solid state relays with galvanic isolation available in J11. Typical applications include HVAC, sprinkler control etc.

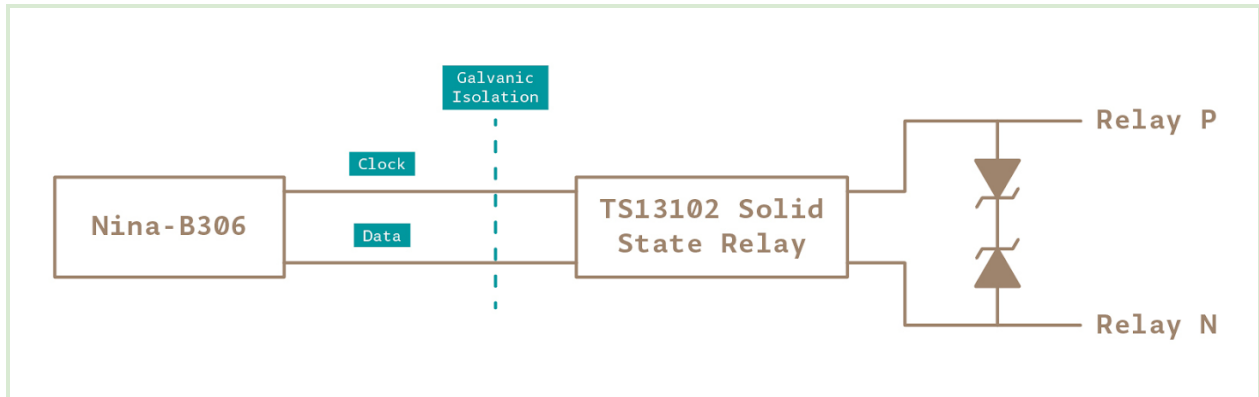

### 3.8 Storage

The board includes both a microSD card socket and an additional 2MB flash memory for data storage. Both are directly connected to the main processor via a SPI interface.

### 3.9 Power tree

The board can be powered via solar panels and/or SLA batteries.

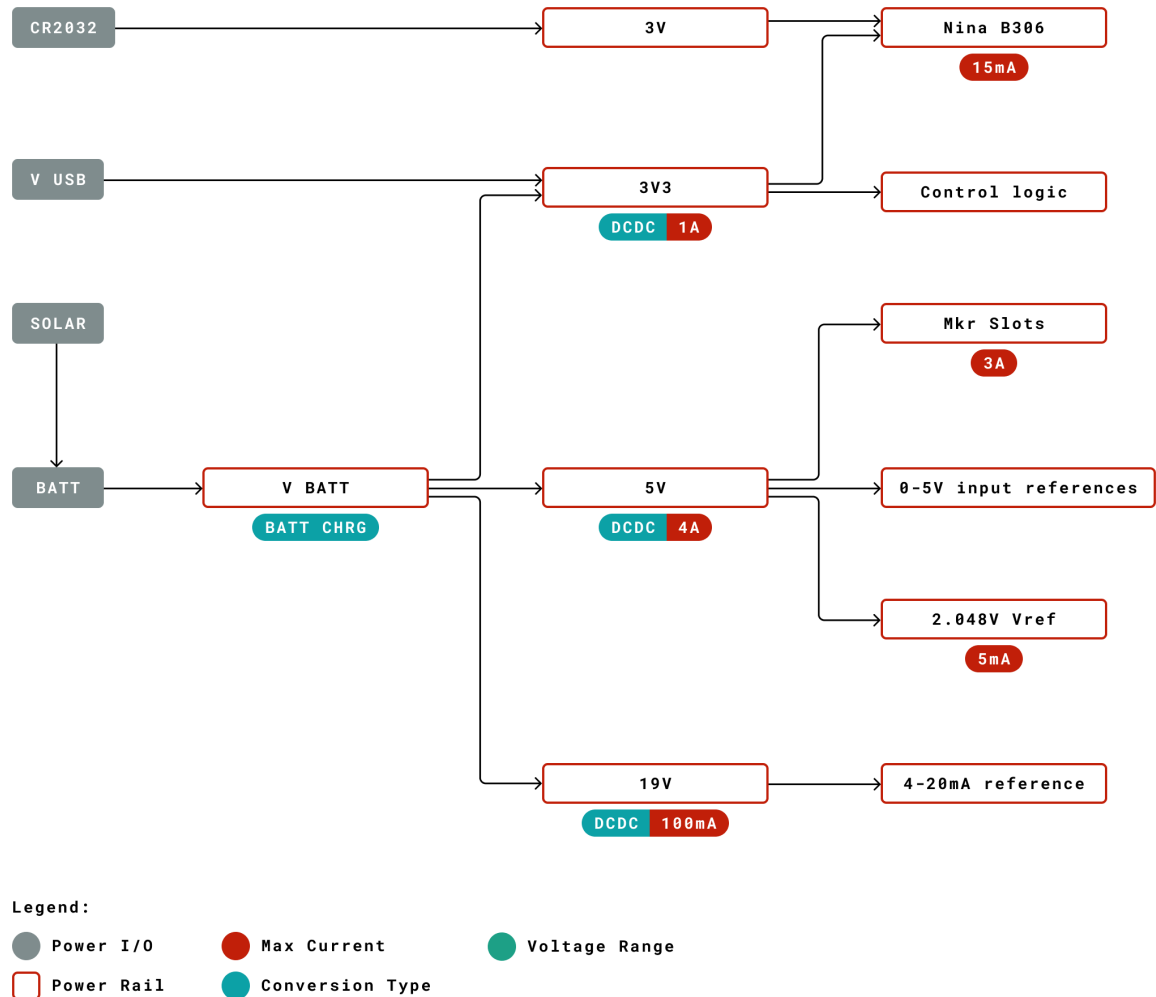

## 4. Board Operation

### 4.1 Getting started - IDE

If you want to program your Arduino Edge Control while offline you need to install the Arduino Desktop IDE [1]. To connect the Arduino Edge control to your computer, you'll need a Micro-B USB cable. This also provides power to the board, as indicated by the LED.

## 4.2 Getting started - Arduino Web Editor

All Arduino boards, including this one, work out-of-the-box on the Arduino Web Editor [\[2\]](#), by just installing a simple plugin.

The Arduino Web Editor is hosted online, therefore it will always be up-to-date with the latest features and support for all boards. Follow [\[3\]](#) to start coding on the browser and upload your sketches onto your board.

## 4.3 Getting started - Arduino IoT Cloud

All Arduino IoT enabled products are supported on Arduino IoT Cloud which allows you to Log, graph and analyze sensor data, trigger events, and automate your home or business.

## 4.4 Sample Sketches

Sample sketches for the Arduino Edge Control can be found either in the “Examples” menu in the Arduino IDE or in the “Documentation” section of the Arduino Pro website [\[4\]](#).

## 4.5 Online resources

Now that you have gone through the basics of what you can do with the board you can explore the endless possibilities it provides by checking exciting projects on ProjectHub [\[5\]](#), the Arduino Library Reference [\[6\]](#) and the online store [\[7\]](#) where you will be able to complement your board with sensors, actuators and more.

## 4.6 Board Recovery

All Arduino boards have a built-in bootloader which allows flashing the board via USB. In case a sketch locks up the processor and the board is not reachable anymore via USB it is possible to enter bootloader mode by double-tapping the reset button right after power up.

# 5. Connector Pinouts

## 5.1 J1 LCD Module Connector

Pin	Function	Type	Description
1	PWM	Power	Backlight LED Cathode (PWM control)
2	Power On	Digital	Button input
3	+5V LCD	Power	LCD power supply
4	LCD RS	Digital	LCD RS signal
5	Contrast	Analog	LCD Contrast control

6	LCD RW	Digital	LCD Read/Write signal
7	LED+	Power	Backlight LED Anode
8	LCD EN	Digital	LCD Enable signal
10	LCD D4	Digital	LCD D4 signal
12	LCD D5	Digital	LCD D5 signal
14	LCD D6	Digital	LCD D6 signal
16	LCD D7	Digital	LCD D7 signal
9,11,13,15	GND	Power	Ground

### 5.2 J3 Wake up signals/External relay commands

Pin	Function	Type	Description
1,3,5,7,9	V BAT	Power	Gated voltage battery for wake up signal reference
2,4,6,8,10,12	Input	Digital	Edge sensitive wake up signals
13	Output	Digital	External solid state relay clock signal 1
14	Output	Digital	External solid state relay clock signal 2
17	Bidir	Digital	External solid state relay data signal 1
18	Bidir	Digital	External solid state relay data signal 2
15,16	GND	Power	Ground

### 5.3 J5 USB

Pin	Function	Type	Description
1	V USB	Power	Power Supply Input Note: A board powered only via V USB will not enable most of the features of the board. Check the power tree in Section 3.8
2	D-	Differential	USB differential data -
3	D+	Differential	USB differential data +
4	ID	NC	Unused
5	GND	Power	Ground

#### 5.4 J7 Analog/4-20mA

Pin	Function	Type	Description
1,3,5,7	+19V	Power	4-20mA voltage reference
2	IN1	Analog	4-20mA input 1
4	IN2	Analog	4-20mA input 2
6	IN3	Analog	4-20mA input 3
8	IN4	Analog	4-20mA input 4
9	GND	Power	Ground
10	+5V	Power	5V output for 0-5V analog reference
11	A5	Analog	0-5V input 5
12	A1	Analog	0-5V input 1
13	A6	Analog	0-5V input 6
14	A2	Analog	0-5V input 2
15	A7	Analog	0-5V input 7
16	A3	Analog	0-5V input 3
17	A8	Analog	0-5V input 8
18	A4	Analog	0-5V input 4

#### 5.5 J8 Watermark

Pin	Function	Type	Description
1	WaterMrk1	Analog	Watermark input 1
2	WaterMrk2	Analog	Watermark input 2
3	WaterMrk3	Analog	Watermark input 3
4	WaterMrk4	Analog	Watermark input 4
5	WaterMrk5	Analog	Watermark input 5
6	WaterMrk6	Analog	Watermark input 6
7	WaterMrk7	Analog	Watermark input 7

8	WaterMrk8	Analog	Watermark input 8
9	WaterMrk9	Analog	Watermark input 9
10	WaterMrk10	Analog	Watermark input 10
11	WaterMrk11	Analog	Watermark input 11
12	WaterMrk12	Analog	Watermark input 12
13	WaterMrk13	Analog	Watermark input 13
14	WaterMrk14	Analog	Watermark input 14
15	WaterMrk15	Analog	Watermark input 15
16	WaterMrk16	Analog	Watermark input 16
17,18	V <sub>COMMON</sub>	Digital	Sensor common voltage

### 5.6 J9 Latching out (+/- VBAT)

Pin	Function	Type	Description
1	PULSE_OUT0_P	Digital	Latching output 1 positive
2	PULSE_OUT0_N	Digital	Latching output 1 negative
3	PULSE_OUT1_P	Digital	Latching output 2 positive
4	PULSE_OUT1_N	Digital	Latching output 2 negative
5	PULSE_OUT2_P	Digital	Latching output 3 positive
6	PULSE_OUT2_N	Digital	Latching output 3 negative
7	PULSE_OUT3_P	Digital	Latching output 4 positive
8	PULSE_OUT3_N	Digital	Latching output 4 negative
9	PULSE_OUT4_P	Digital	Latching output 5 positive
10	PULSE_OUT4_N	Digital	Latching output 5 negative
11	PULSE_OUT5_P	Digital	Latching output 6 positive
12	PULSE_OUT5_N	Digital	Latching output 6 negative
13	PULSE_OUT6_P	Digital	Latching output 7 positive
14	PULSE_OUT6_N	Digital	Latching output 7 negative
15	PULSE_OUT7_P	Digital	Latching output 8 positive



16	PULSE_OUT7_N	Digital	Latching output 8 negative
17,18	GND	Power	Ground

### 5.7 J10 Latching command (+/- VBAT)

Pin	Function	Type	Description
1	STOBE8_P	Digital	Latching command 1 positive
2	STOBE8_N	Digital	Latching command 1 negative
3	STOBE9_P	Digital	Latching command 2 positive
4	STOBE9_N	Digital	Latching command 2 negative
5	STOBE10_P	Digital	Latching command 3 positive
6	STOBE10_N	Digital	Latching command 3 negative
7	STOBE11_P	Digital	Latching command 4 positive
8	STOBE11_N	Digital	Latching command 4 negative
9	STOBE12_N	Digital	Latching command 5 positive
10	STOBE12_P	Digital	Latching command 5 negative
11	STOBE13_P	Digital	Latching command 6 positive
12	STOBE13_N	Digital	Latching command 6 negative
13	STOBE14_P	Digital	Latching command 7 positive
14	STOBE14_N	Digital	Latching command 7 negative
15	STOBE15_P	Digital	Latching command 8 positive
16	STOBE15_N	Digital	Latching command 8 negative
17	GATED_VBAT_PULSE	Power	Gated Positive terminal of battery
18	GND	Power	Ground

### 5.8 J11 Relay (+/- VBAT)

Pin	Function	Type	Description
1	SOLAR+	Power	Solar Panel Positive Terminal
2	NC	NC	Unused

3	GND	Power	Ground
4	RELAY1_P	Switch	Relay 1 positive
5	NC	NC	Unused
6	RELAY1_N	Switch	Relay 1 negative
7	NC	NC	Unused
8	RELAY2_P	Switch	Relay 2 positive
9	NC	NC	Unused
10	RELAY2_N	Switch	Relay 2 negative
11	10kGND	Power	Ground via 10k resistor
12	RELAY3_P	Switch	Relay 3 positive
13	NTC	Analog	Negative temperature coefficient (NTC) thermoresistor
14	RELAY3_N	Switch	Relay 3 negative
15	GND	Power	Ground
16	RELAY4_P	Switch	Relay 4 positive
17	BATTERY+	Power	Battery Positive Terminal
18	RELAY4_N	Switch	Relay 4 negative

## 6. Mechanical Information

### 6.1 Board outline

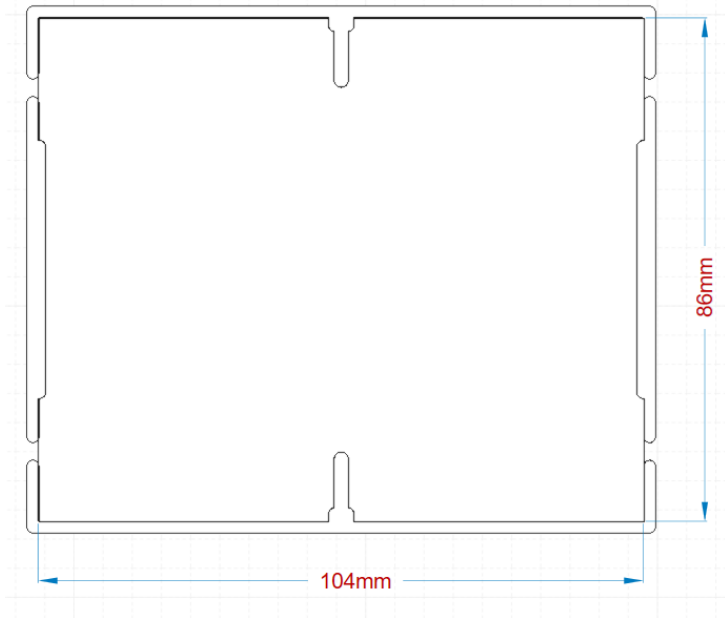

### 6.2 Mounting holes

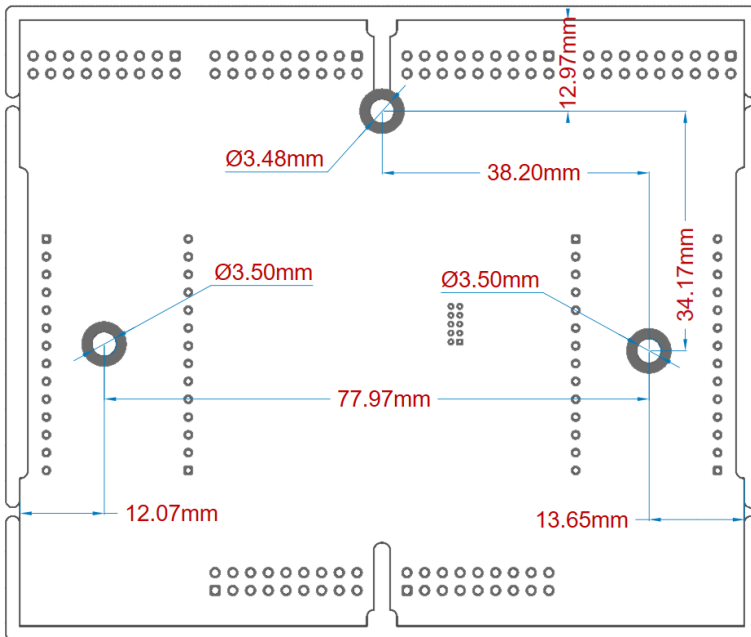

6.3 Connector Positions

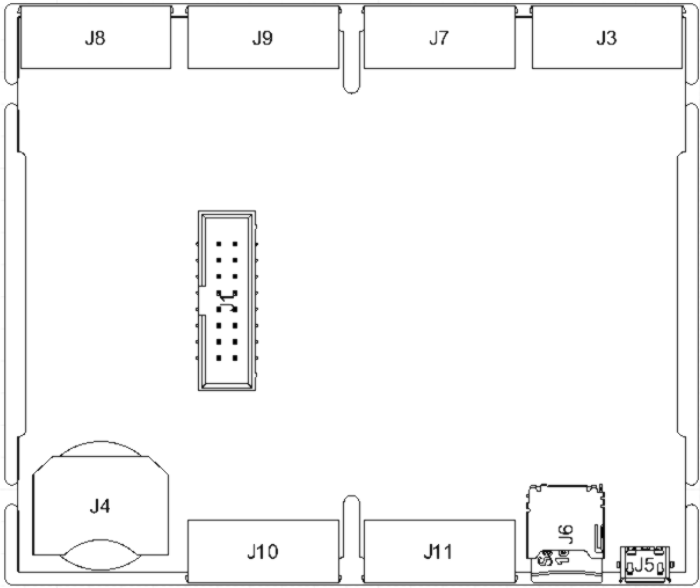

## 7. Certifications

### 7.1 Declaration of Conformity CE DoC (EU)

We declare under our sole responsibility that the products above are in conformity with the essential requirements of the following EU Directives and therefore qualify for free movement within markets comprising the European Union (EU) and European Economic Area (EEA).

#### **ROHS 2 Directive 2011/65/EU**

Conforms to: EN50581:2012

#### **Directive 2014/35/EU. (LVD)**

Conforms to: EN 60950-1:2006/A11:2009/A1:2010/A12:2011/AC:2011

#### **Directive 2004/40/EC & 2008/46/EC & 2013/35/EU, EMF**

Conforms to: EN 62311:2008

### 7.2 Declaration of Conformity to EU RoHS & REACH 211 01/19/2021

Arduino boards are in compliance with RoHS 2 Directive 2011/65/EU of the European Parliament and RoHS 3 Directive 2015/863/EU of the Council of 4 June 2015 on the restriction of the use of certain hazardous substances in electrical and electronic equipment.

<b>Substance</b>	<b>Maximum Limit (ppm)</b>
Lead (Pb)	1000
Cadmium (Cd)	100
Mercury (Hg)	1000
Hexavalent Chromium (Cr6+)	1000
Poly Brominated Biphenyls (PBB)	1000
Poly Brominated Diphenyl ethers (PBDE)	1000
Bis(2-Ethylhexyl} phthalate (DEHP)	1000
Benzyl butyl phthalate (BBP)	1000
Dibutyl phthalate (DBP)	1000
Diisobutyl phthalate (DIBP)	1000

Exemptions : No exemptions are claimed.

Arduino Boards are fully compliant with the related requirements of European Union Regulation (EC) 1907 /2006 concerning the Registration, Evaluation, Authorization and Restriction of Chemicals (REACH). We declare none of the SVHCs



(<https://echa.europa.eu/web/guest/candidate-list-table>), the Candidate List of Substances of Very High Concern for authorization currently released by ECHA, is present in all products (and also package) in quantities totaling in a concentration equal or above 0.1%. To the best of our knowledge, we also declare that our products do not contain any of the substances listed on the "Authorization List" (Annex XIV of the REACH regulations) and Substances of Very High Concern (SVHC) in any significant amounts as specified by the Annex XVII of Candidate list published by ECHA (European Chemical Agency) 1907 /2006/EC.

### 7.3 Conflict Minerals Declaration

As a global supplier of electronic and electrical components, Arduino is aware of our obligations with regards to laws and regulations regarding Conflict Minerals, specifically the Dodd-Frank Wall Street Reform and Consumer Protection Act, Section 1502. Arduino does not directly source or process conflict minerals such as Tin, Tantalum, Tungsten, or Gold. Conflict minerals are contained in our products in the form of solder, or as a component in metal alloys. As part of our reasonable due diligence Arduino has contacted component suppliers within our supply chain to verify their continued compliance with the regulations. Based on the information received thus far we declare that our products contain Conflict Minerals sourced from conflict-free areas.

## 8. FCC Caution

Any Changes or modifications not expressly approved by the party responsible for compliance could void the user's authority to operate the equipment.

This device complies with part 15 of the FCC Rules. Operation is subject to the following two conditions:

- (1) This device may not cause harmful interference
- (2) this device must accept any interference received, including interference that may cause undesired operation.

### **FCC RF Radiation Exposure Statement:**

1. This Transmitter must not be co-located or operating in conjunction with any other antenna or transmitter.
2. This equipment complies with RF radiation exposure limits set forth for an uncontrolled environment.



3. This equipment should be installed and operated with minimum distance 20cm between the radiator & your body.

**English:**

User manuals for licence-exempt radio apparatus shall contain the following or equivalent notice in a conspicuous location in the user manual or alternatively on the device or both. This device complies with Industry Canada licence-exempt RSS standard(s). Operation is subject to the following two conditions:

(1) this device may not cause interference

(2) this device must accept any interference, including interference that may cause undesired operation of the device.

**French:**

Le présent appareil est conforme aux CNR d'Industrie Canada applicables aux appareils radio exempts de licence. L'exploitation est autorisée aux deux conditions suivantes :

(1) l' appareil ne doit pas produire de brouillage

(2) l'utilisateur de l'appareil doit accepter tout brouillage radioélectrique subi, même si le brouillage est susceptible d'en compromettre le fonctionnement.

**IC SAR Warning:**

**English**

This equipment should be installed and operated with minimum distance 20 cm between the radiator and your body.

**French:**

Lors de l' installation et de l' exploitation de ce dispositif, la distance entre le radiateur et le corps est d 'au moins 20 cm.

**Important:** The operating temperature of the EUT can't exceed 85°C and shouldn't be lower than -40°C.

Hereby, Arduino S.r.l. declares that this product is in compliance with essential requirements and other relevant provisions of Directive 2014/53/EU. This product is allowed to be used in all EU member states.

Frequency bands	Maximum output power (ERP)
863-870Mhz	-3.22dBm

## 9. Company information

Company name	Arduino S.r.l.
Company Address	Via Ferruccio Pelli 14, 6900 Lugano, TI (Ticino), Switzerland

## 10. Reference Documentation

Ref	Link
1. Arduino IDE (Desktop)	<a href="https://www.arduino.cc/en/Main/Software">https://www.arduino.cc/en/Main/Software</a>
2. Arduino IDE (Cloud)	<a href="https://create.arduino.cc/editor">https://create.arduino.cc/editor</a>
3. Cloud IDE Getting Started	<a href="https://create.arduino.cc/projecthub/Arduino_Genuino/getting-started-with-arduino-web-editor-4b3e4a">https://create.arduino.cc/projecthub/Arduino_Genuino/getting-started-with-arduino-web-editor-4b3e4a</a>
4. Arduino Pro Website	<a href="https://www.arduino.cc/pro">https://www.arduino.cc/pro</a>
5. Project Hub	<a href="https://create.arduino.cc/projecthub?by=part&amp;part_id=11332&amp;sort=trending">https://create.arduino.cc/projecthub?by=part&amp;part_id=11332&amp;sort=trending</a>
6. Library Reference	<a href="https://github.com/bcmlabs/Arduino_EdgeControl/tree/4dad0d95e93327841046c1ef80bd8b882614eac8">https://github.com/bcmlabs/Arduino_EdgeControl/tree/4dad0d95e93327841046c1ef80bd8b882614eac8</a>
7. Online Store	<a href="https://store.arduino.cc/">https://store.arduino.cc/</a>

## 11. Revision History

Date	Revision	Changes
02/21/2020	1	First Release
02/10/2021	2	Design/structure update



## **X-ON Electronics**

Largest Supplier of Electrical and Electronic Components

*Click to view similar products for [Arduino manufacturer](#):*

Other Similar products are found below :

[A000005](#) [A000024](#) [A000026](#) [A000052](#) [A000053](#) [A000056](#) [A000057](#) [A000062](#) [A000066](#) [A000067](#) [A000070](#) [A000072](#) [A000073](#) [A000079](#)  
[A000080](#) [A000093](#) [ABX00004](#) [ABX00011](#) [ABX00012](#) [ABX00017](#) [ABX00019](#) [ABX00021](#) [ABX00022](#) [ABX00023](#) [ABX00027](#)  
[ABX00028](#) [ABX00029](#) [ABX00030](#) [ABX00033](#) [ABX00034](#) [ABX00042](#) [ABX00047](#) [IOT STARTER CARRIER](#) [AKX00002](#) [AKX00002SL](#)  
[AKX00004](#) [AKX00015](#) [AKX00016](#) [AKX00026](#) [AKX00027](#) [ANTENNA GSM](#) [ARDUINO 4 RELAYS SHIELD](#) [ARDUINO DUE](#)  
[ARDUINO EDGE CONTROL](#) [ARDUINO ENGINEERING KIT REV2](#) [ARDUINO ESPLORA RETAIL](#) [ARDUINO ETH SHIELD 2](#)  
[WITHOUT POE](#) [ARDUINO LEONARDO WITH HEADERS](#) [ARDUINO LEONARDO W/O HEADERS](#) [ARDUINO MEGA2560 REV3](#)  
[ARDUINO MICRO RETAIL](#)