

ARKLED 无锡市方舟科技电子有限公司

WUXI ARK TECHNOLOGY ELECTRONIC CO., LTD

规格(承认)书

Specification for approval

※ 方舟 P/N (ARKLED P/N): SM453001L3-2

※ 客户 P/N (CUSTOMER P/N): _____

※ 产品说明 (DESCRIPTION):

1、

2、

3、

※ 日期 (DATE): 2015 年 09 月 22 日

地址: 江苏省宜兴市张渚镇金张渚工业区宇龙路 6 号

ADD: NO.6 Yulong Road, ZHANGZHU TOWN, YIXING CITY, JIANGSU PROVINCE,
P.R.CHINA

电话 (TEL): 0086-510-87341161 87345700

传真(FAX): 0086-510-87342800

E-mail: zpz@arkchn.com

网址(http) : www.arkch.com

型号 Type :

SM453001L3-2



■ 产品特征 FEATURES:

- 高可靠性和高稳定性

High intensity and reliability

- 高品质、和低功耗、低成本

High quality, Low power requirement and low cost

- IC 易兼容、易装配

IC compatible , Easy assembly

- 符合 RoHS 指令要求

Meet RoHS EU Directive

- 静电承受能力 200V

ESD 200V

■ 产品描述 DESCRIPTION:

- 3.0 英寸单位数码管

3.0 Inch Single Digits Display

- 极性共阳

Common Anode

- 黑面, 白胶

Black face, white segment

- 发光颜色

Lighting Color:

1、红色 Red

2、

3、

4、

5、

- 晶片材质

1、AlGaInP

2、

3、

4、

5、

型号 Type :

SM453001L3-2



■ 产品最大绝对参数值 (Ta: 25°C) ABSOLUTE MAXIMUM RATINGS AT Ta=25°C:

PARAMETER 项目	SYMBOL 符号	RED 红色	UNIT 单位
Power Dissipation Per Segment 功耗	PAD	50	mw
Reverse Voltage Per Segment 反向耐压	VR	5	V
Continuous Forward Current Per Segment 最大使用电流	IAF	20	mA
Peak Forward Current Per Segment(Duty-0.1,1KHz) 最大峰值电流	IPF	60	mA
Operating Temperature Range 工作温度	TOPr	-20°C to 80°C	
Storage Temperature Range 贮藏温度	Tstg	-30°C to 85°C	
Lead Soldering Temperature 260°C at 1.6mm From Body for 3 second 焊接温度 260°C/3 秒 距离胶体 1.6mm 以上			

■ 产品光电参数值 (Ta: 25°C) ELECTRICAL/OPTICAL CHARACTERISTICS AT Ta=25°C:

PARAMETER 项目	SYMBOL 符号	TEST CONDITION 测试条件	Color 颜色	MIN 最小值	TYP 标准值	MAX 最大值	UNIT 单位
Forward Voltage ,Per Segment 正向压降	VF	IF=20mA	红色 RED	单芯 1.8	2	2.5	V
Reverse Current , Per Segment 反向漏电流	IR	VR=5V	红色 RED			50	μA
Peak Emission Wavelength 峰值波长	λp	IF=20mA	红色 RED	620		625	nm
Luminous Intensity Per Segment 法向光强	IV	IF=20mA	红色 RED	114		120	mcd

型号 Type :
SM453001L3-2



RELATIVE INTENSITY VS. WAVELENGTH

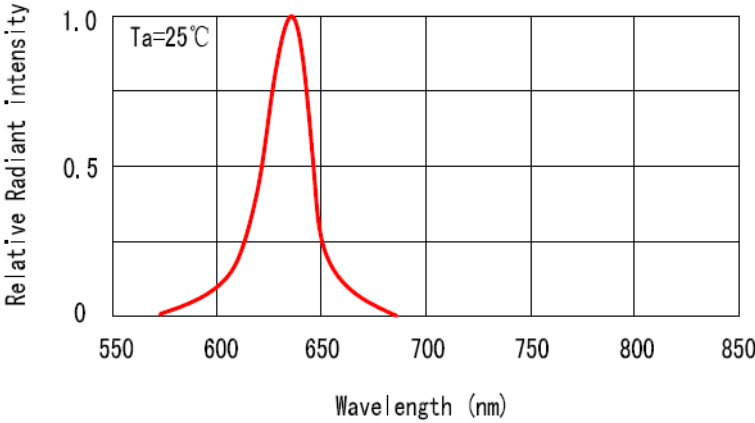

FORWARD CURRENT VS. FORWARD VOLTAGE

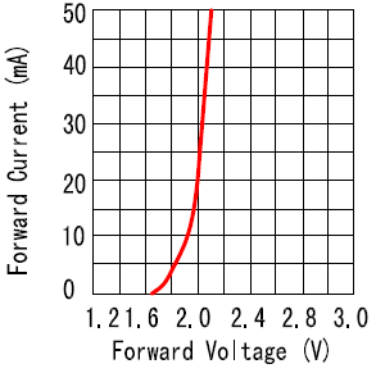

LUMINOUS INTENSITY VS. FORWARD CURRENT

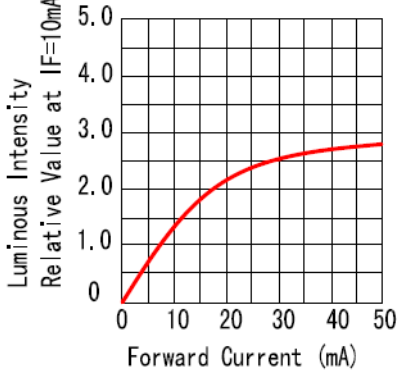

ALLOWABLE FORWARD CURRENT AMBIENT TEMPERATURE

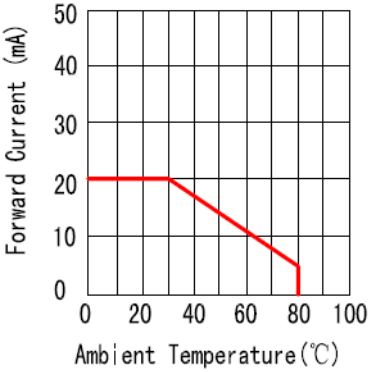

LUMINOUS INTENSITY VS. AMBIENT TEMPERATURE

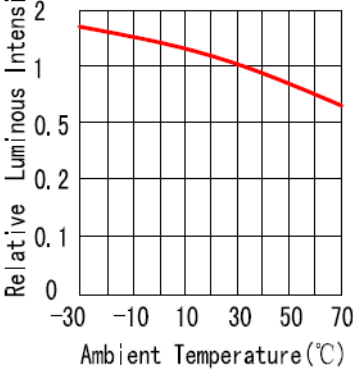

型号 Type :
SM453001L3-2

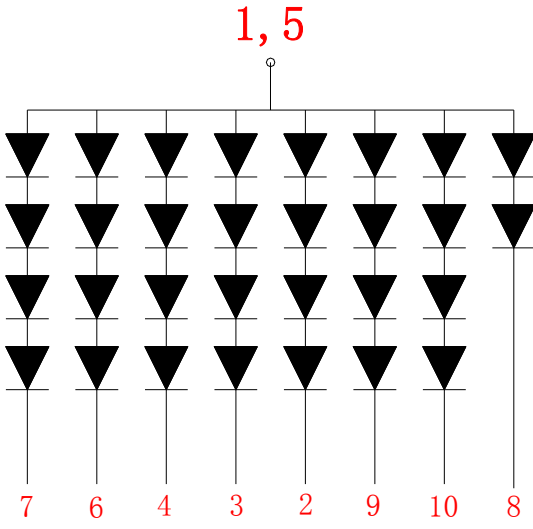
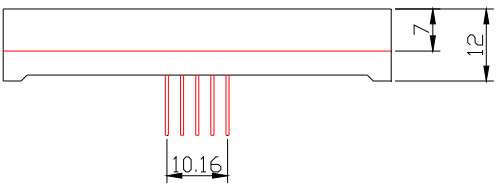
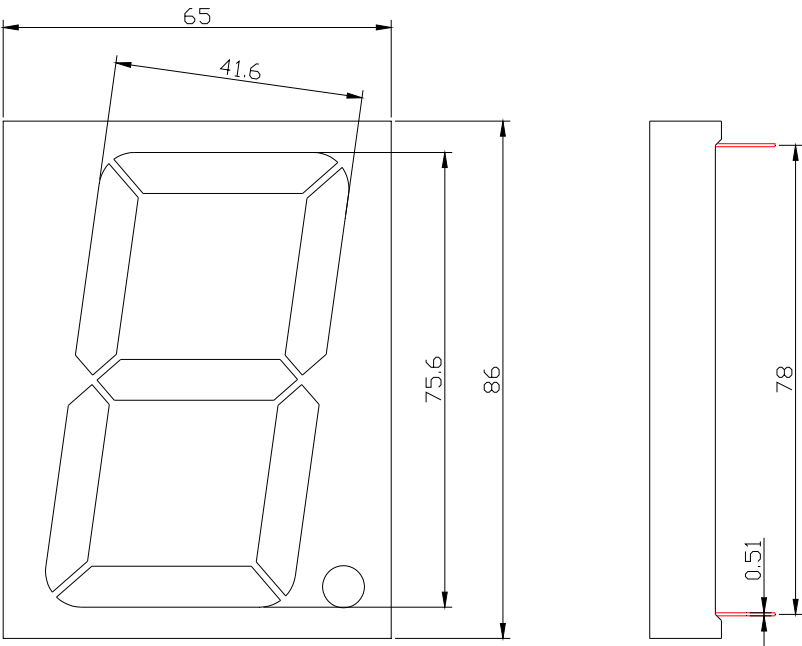

NOTES : 1. All dimensions are in millimeters. (inches)

2. Tolerance is $\pm 0.25(0.010)$ unless otherwise specified.

X-ON Electronics

Largest Supplier of Electrical and Electronic Components

Click to view similar products for [LED Displays & Accessories](#) category:

Click to view products by [ARK Tech](#) manufacturer:

Other Similar products are found below :

[LTC-2721WC](#) [LTC-4627G](#) [LTC-4627WC](#) [LTD-5021AWC](#) [LTP-4323P](#) [LTS-3361JG-06](#) [ELS-316SYGWA/S530-E2](#) [1668](#) [HT-F196NB-5323](#) [SA03-12EWA](#) [LDQ-N514RI](#) [LDS-A3506RD](#) [LDS-A3926RI](#) [SI-B9T151550WW](#) [SI-B9V171550WW](#) [SLC-3PF-WL](#) [1624](#) [LTC-2621JD](#) [LTC-2623WC](#) [LTC-4624P](#) [LTC-4627JD](#) [LTP-1057AHR](#) [LTP-1457AKR](#) [LTP-3784G-01](#) [LTS-4812SKR-P](#) [LTS-6780P](#) [HV-7W30-6829](#) [DA43-11GWA](#) [LDD-E305RI](#) [LDQ-N3402RI](#) [LDQ-N3606RI](#) [LDS-A3924RI-SI](#) [LDT-M2804RI](#) [86004CB830](#) [LTP-3862JD](#) [LTP-2088AKD](#) [LTD-6740P](#) [LTC-4727E](#) [LTS-312AY](#) [LTS-6880Y](#) [LDS-SMC3002RISUGTR](#) [LTC-2623E](#) [CC25-12YWA](#) [LDM-6432-P3-UR-1](#) [EADSF056RA1](#) [LDF-U8004BI](#) [SLCN-42M-W](#) [LTC-3710G](#) [LTS-4801KF](#) [ACSA04-41QWWA/D](#)