

ARKLED 无锡市方舟科技电子有限公司
WUXIARK TECHNOLOGY ELECTRONIC CO., LTD

规格(承认)书

Specification for Approval

※ 方舟 P/N (ARKLED P/N): SP410801N

※ 客户 P/N (CUSTOMER P/N):

※ 日期 (DATE): 2017 年 04 月 18 日

制定: 刘杰 审核:



地址: 江苏省宜兴市金张渚工业集中区宇龙路 6 号

Add: NO.6, Yulong Road, Golden Zhangzhu Industrial Park, Yixing City, Jiangsu Province, China

电话(Tel): 销售(Sales):0086-510-87341161 87395800

邮箱(Email): 销售(Sales):sales@arkchn.com

传真(Fax): 0086-510-87342800

技术(Tech): 0086-510-87341558

技术(Tech): tech@arkchn.com

网址(Website): www.arkch.com

型号 PART NUMBER:

SP410801N



Page1 / 4

■ 产品特征 FEATURES:

- 高可靠性和高稳定性

High intensity and reliability

- 高品质、和低功耗、低成本

High quality, Low power requirement and low cost

- IC 易兼容、易装配

IC compatible, Easy assembly

- 符合 RoHS 指令要求

Meet RoHS EU Directive

- 静电承受能力 1000V (HBM)
- ESD 1000V (HBM)

■ 产品描述 DESCRIPTION:

- 三位数码管 Three digits 7 segment LED display

- 极性:共阳 Common Anode

- 表面颜色 Surface Color: 黑面 Black surface

- 笔段颜色: 黄胶 Yellow segment

- 发光颜色 luminous Color:

1、红色 Red

2、选择一项。

3、选择一项。

4、选择一项。

5、选择一项。

- 晶片材质

1、AlGaInP

2、选择一项。

3、选择一项。

4、选择一项。

5、选择一项。

型号 PART NUMBER:

SP410801N



■ 产品最大绝对参数值 (Ta: 25°C) ABSOLUTE MAXIMUM RATINGS AT Ta=25°C:

PARAMETER 项目	SYMBOL 符号	RED 红色	UNIT 单位
Power Dissipation Per Segment 功耗	PAD	50	mw
Reverse Voltage Per Segment 反向耐压	VR	5	V
Continuous Forward Current Per Segment 最大使用电流	IAF	20	mA
Peak Forward Current Per Segment(Duty-0.1,1KHz) 最大峰值电流	IPF	60	mA
Operating Temperature Range 工作温度	TOPr	-20°C to 70°C	
Storage Temperature Range 贮藏温度	Tstg	-20°C to 80°C	
Lead Soldering Temperature 260°C at 1.6mm From Body for 3 second 焊接温度 260°C/3 秒 距离胶体 1.6mm 以上			

■ 产品光电参数值 (Ta: 25°C) ELECTRICAL/OPTICAL CHARACTERISTICS AT Ta=25°C:

PARAMETER 项目	SYMBOL 符号	TEST CONDITION 测试条件	Color 颜色	MIN 最小 值	TYP 标准值	MAX 最大值	UNIT 单位
Forward Voltage ,Per Segment 正向压降	VF	IF=20mA	红色 RED	1.8	2	2.5	V
Reverse Current , Per Segment 反向漏电流	IR	VR=5V	红色 RED			50	µA
Dominant wavelength 主波长	λD	IF=20mA	红色 RED	630	635	637	nm
Luminous Intensity Per Segment 法向光强	IV	IF=20mA	红色 RED	30		37	mcd

型号 PART NUMBER:

SP410801N



■光电曲线图 TYPICAL ELECTRO-OPTICAL CHARACTERISTICS CURVES

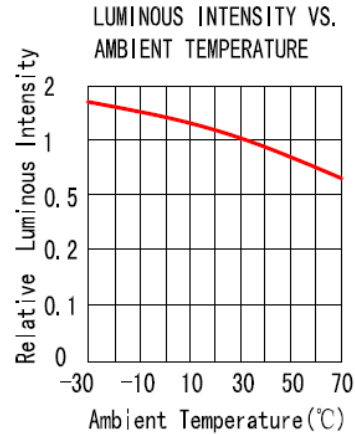
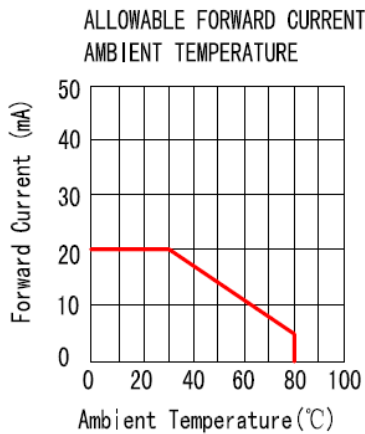
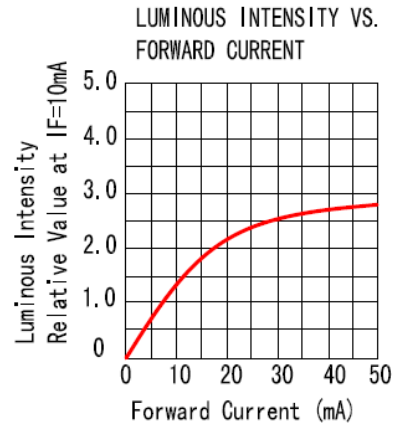
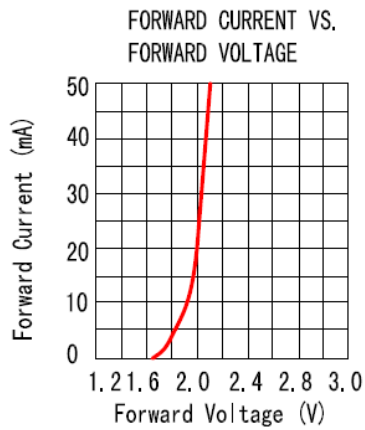
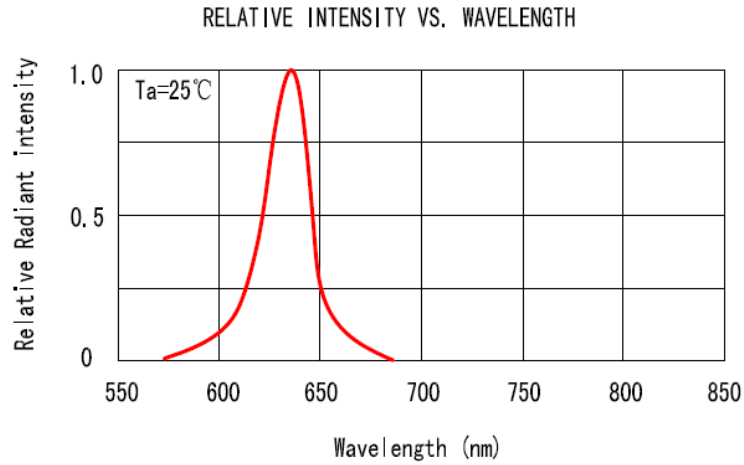

型号 PART NUMBER:

SP410801N



产品尺寸和原理图 DIMENTION AND DIAGRAM

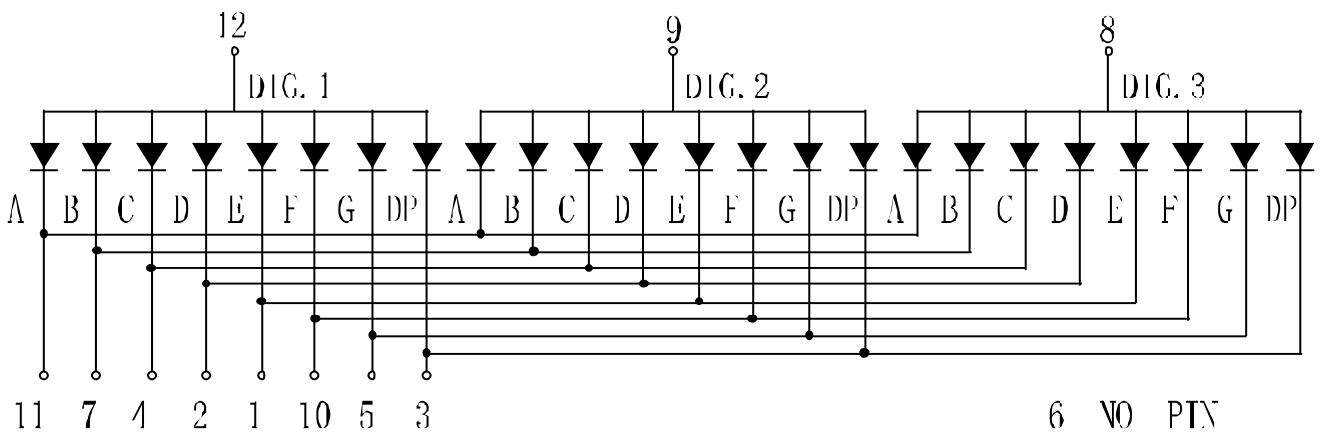
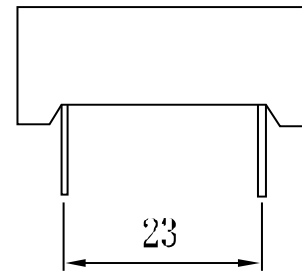
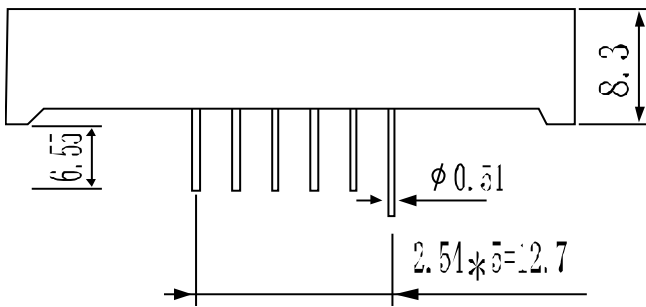
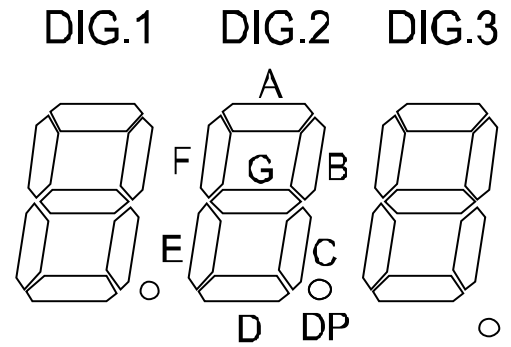
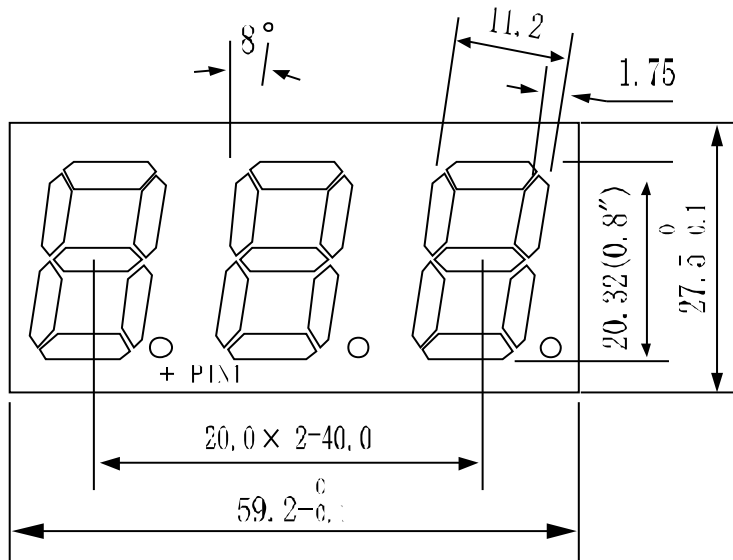

NOTES : 1.单位为毫米. All dimensions are in millimeters. (Inches)

2. 误差一般为±0.25. Tolerance is ±0.25(0.010") unless otherwise specified.

X-ON Electronics

Largest Supplier of Electrical and Electronic Components

Click to view similar products for [LED Displays & Accessories](#) category:

Click to view products by [ARK Tech](#) manufacturer:

Other Similar products are found below :

[LTC-2721WC](#) [LTC-4627G](#) [LTC-4627WC](#) [LTD-5021AWC](#) [LTP-4323P](#) [LTS-3361JG-06](#) [ELS-316SYGWA/S530-E2](#) [1668](#) [HT-F196NB-5323](#) [SA03-12EWA](#) [LDQ-N514RI](#) [LDS-A3506RD](#) [LDS-A3926RI](#) [SI-B9T151550WW](#) [SI-B9V171550WW](#) [SLC-3PF-WL](#) [1624](#) [LTC-2621JD](#) [LTC-2623WC](#) [LTC-4624P](#) [LTC-4627JD](#) [LTP-1057AHR](#) [LTP-1457AKR](#) [LTP-3784G-01](#) [LTS-4812SKR-P](#) [LTS-6780P](#) [HV-7W30-6829](#) [DA43-11GWA](#) [LDD-E305RI](#) [LDQ-N3402RI](#) [LDQ-N3606RI](#) [LDS-A3924RI-SI](#) [LDT-M2804RI](#) [86004CB830](#) [LTP-3862JD](#) [LTP-2088AKD](#) [LTD-6740P](#) [LTC-4727E](#) [LTS-312AY](#) [LTS-6880Y](#) [LDS-SMC3002RISUGTR](#) [LTC-2623E](#) [CC25-12YWA](#) [LDM-6432-P3-UR-1](#) [EADSF056RA1](#) [LDF-U8004BI](#) [SLCN-42M-W](#) [LTC-3710G](#) [LTS-4801KF](#) [ACSA04-41QWWA/D](#)