

## ADNB 96W Series

Up to 96 Watts  
Din Rail

**Total Power:** Up to 96 Watts  
**Input Voltage:** 88 to 264 Vac  
124 to 370 Vdc  
**# of Outputs:** Single

### Special Features

- Universal AC input 88-264Vac
- Installed on DIN rail TS35/7.5 or 15
- Brown-out Protection
- Protections: Short Circuit/Over load/Over voltage
- All using 105degC long life electrolytic capacitors
- High operation temperature up to 70°C
- Withstand 2G vibration test
- High efficiency, long life and high reliability
- 3 Years Warranty

### Safety\*

UL /cUL 508  
TUV EN60950-1  
LPS Pass  
UL1310 class 2 (except ADNB075-12-1PM-C, ADNB064-15-1PM-C)

Note\* - Cover AC input only



## Product Descriptions

The ADNB 96W series features a universal 88-264Vac input – enabling it to be used anywhere in the world – and is also capable of operating from a 124-370Vdc Input. The ADNB 96W series offers a power rating up to 96W with convection cooling, and it provides precisely regulated output voltages of 12V, 15V, 24V and 48Vdc.

The ADNB 96W series power supply is comprehensively protected against over voltage, over load and short-circuit conditions.

## Model Numbers

Model	Output Voltage	Minimum Load	Maximum Load	Efficiency <sup>1</sup>
ADNB075-12-1PM-C	12Vdc	0A	7.5A	87%
ADNB064-15-1PM-C	15Vdc	0A	6.4A	87%
ADNB040-24-1PM-C	24Vdc	0A	4.0A	88%
ADNB020-48-1PM-C	48Vdc	0A	2.0A	87%

Note 1 - Typical value at nominal input voltage(230Vac) and maximum load.

## Options

None

## Electrical Specifications

### Absolute Maximum Ratings

Stress in excess of those listed in the “Absolute Maximum Ratings” may cause permanent damage to the power supply. These are stress ratings only and functional operation of the unit is not implied at these or any other conditions above those given in the operational sections of this TRN. Exposure to any absolute maximum rated condition for extended periods may adversely affect the power supply’s reliability.

Table 1. Absolute Maximum Ratings:

Parameter	Model	Symbol	Min	Typ	Max	Unit
Input Voltage AC continuous operation DC continuous operation	All models	$V_{IN,AC}$	88	-	264	Vac
	All models	$V_{IN,DC}$	124	-	370	Vdc
Maximum Output Power Convection continuous operation	ADNB075-12-1PM-C	$P_{O,max}$	-	-	90	W
	ADNB064-15-1PM-C		-	-	96	W
	ADNB040-24-1PM-C		-	-	96	W
	ADNB020-48-1PM-C		-	-	96	W
Isolation Voltage Input to Output Input to Safety Ground Output to Earth Ground	All models		-	-	4242	Vdc
	All models		-	-	2121	Vdc
	All models		-	-	500	Vdc
Ambient Operating Temperature	All models	$T_A$	-20	-	+70 <sup>1</sup>	°C
Storage Temperature	All models	$T_{STG}$	-40	-	+85	°C
Humidity (non-condensing) Operating Non-operating	All models		20	-	90	%
	All models		10	-	95	%
MTBF	All models		-	330 <sup>2</sup>	-	Khours

Note 1 - Derate each output at 2.5% per degree C from 50 °C to 70 °C.

Note 2 - Certified MIL-HDBK-217F, tested at 25degC,230Vac.

## Input Specifications

Table 2. Input Specifications:

Parameter	Conditions	Symbol	Min	Typ	Max	Unit	
Operating Input Voltage, AC <sup>1</sup>	All	$V_{IN,AC}$	88	115/230	264	Vac	
Operating Input Voltage, DC	All	$V_{IN,DC}$	124	-	370	Vdc	
Input AC Frequency	All	$f_{IN}$	47	50/60	63	Hz	
Input Current	$V_{IN,AC} = 115Vac$ $V_{IN,AC} = 230Vac$	$I_{IN,max}$	-	1.1 0.55	-	A	
No Load Input Power ( $V_O = ON$ , $I_O = 0A$ )	$V_{IN,AC} = 115/230Vac$	$P_{IN,no-load}$	-	-	5	W	
Harmonic Line Currents	All	THD	EN61000-3-2/EN61000-3-3				
Startup Surge Current (Inrush) @ 25°C	$V_{IN,AC} = 230Vac$	$I_{IN,surge}$	-	60	-	$A_{PK}$	
Efficiency ( $T_A = 25°C$ , free air convection cooling)	ADNB075-12-1PM-C ADNB064-15-1PM-C ADNB040-24-1PM-C ADNB020-48-1PM-C	$V_{IN,AC} = 230Vac$ $I_O = I_{O,max}$	$\eta$	-	87 87 88 87	- - - -	%
Hold Up Time	$V_{IN,AC} = 115Vac$ $P_O = P_{O,max}$	$t_{Hold-Up}$	16	-	-	mSec	
	$V_{IN,AC} = 230Vac$ $P_O = P_{O,max}$	$t_{Hold-Up}$	32	-	-	mSec	
Turn On Delay	$V_{IN,AC} = 115Vac$ $P_O = P_{O,max}$	$t_{Turn-On}$	-	-	800	mSec	
	$V_{IN,AC} = 230Vac$ $P_O = P_{O,max}$	$t_{Turn-On}$	-	-	800	mSec	
Leakage Current to safety ground	$V_{IN} = 240Vac$ $f_{IN} = 50/60Hz$	$I_{IN,leakage}$	-	-	1000	$\mu A$	

## Output Specifications

Table 3. Output Specifications:

Parameter	Conditions	Symbol	Min	Typ	Max	Unit
Factory Set Point Accuracy	All	$V_O$	-1.0	-	+1.0	%
Output Voltage	ADNB075-12-1PM-C ADNB064-15-1PM-C ADNB040-24-1PM-C ADNB020-48-1PM-C	$V_O$	-	12.0 15.0 24.0 48.0	-	Vdc
Output Adjust Range	ADNB075-12-1PM-C ADNB064-15-1PM-C ADNB040-24-1PM-C ADNB020-48-1PM-C	$V_O$	10.8 13.5 21.6 43.2	-	13.2 16.5 26.4 52.8	Vdc
Output Ripple, pk-pk	ADNB075-12-1PM-C ADNB064-15-1PM-C ADNB040-24-1PM-C ADNB020-48-1PM-C	$V_O$	-	-	180 180 180 250	mV <sub>PK-PK</sub>
Convection Output Current, continuous	ADNB075-12-1PM-C ADNB064-15-1PM-C ADNB040-24-1PM-C ADNB020-48-1PM-C	$I_{O,max}$	0 0 0 0	-	7.5 6.4 4.0 2.0	A
Line Regulation	$V_{IN,DC} = V_{IN,min}$ to $V_{IN,max}$ $I_O = I_{O,max}$	$V_O$	-1.0	-	+1.0	%
Load Regulation	$I_O = I_{O,min}$ to $I_{O,max}$	$V_O$	-2.0	-	+2.0	%
$V_O$ Over Voltage Protection	Latch off (AC recycle to reset)	$V_O$	115	-	150	%
$V_O$ Over Current Protection <sup>1</sup>	All	$I_O$	102	-	-	% $I_{O,max}$

Note 1 - Hiccup mode and auto recovery after fault condition is removed.

## ADNB075-12-1PM-C Performance Curves

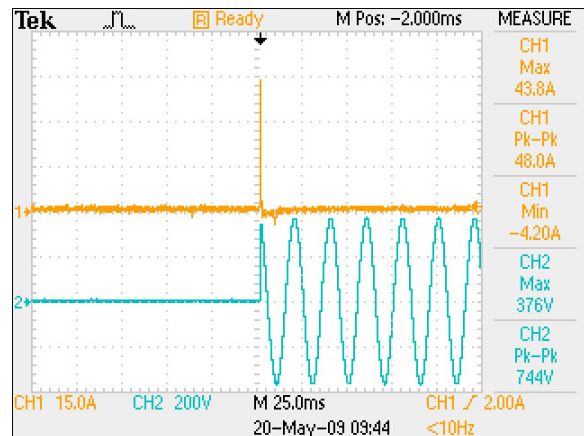
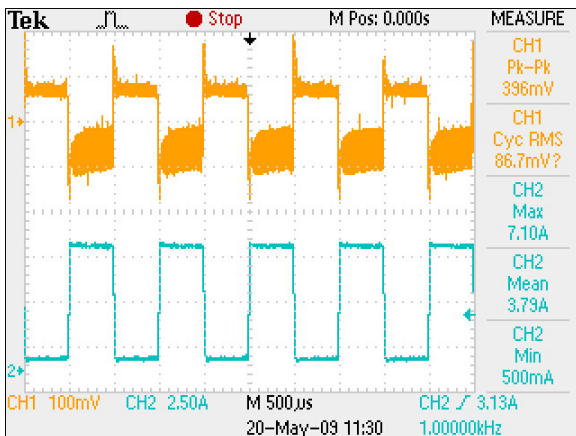
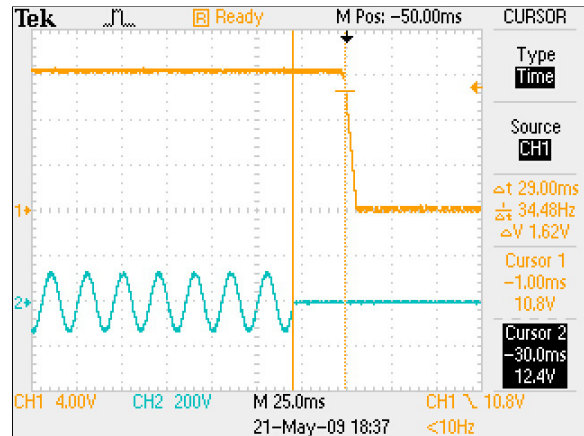
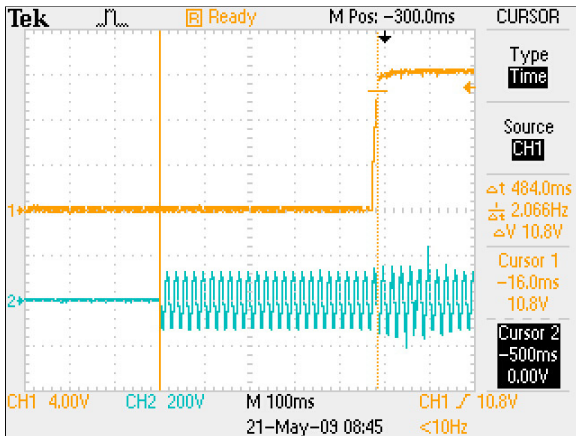
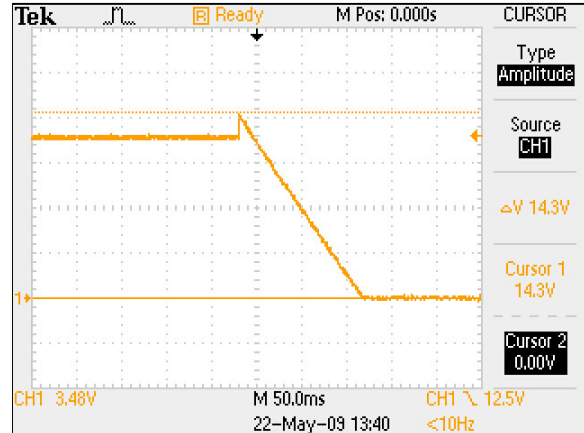
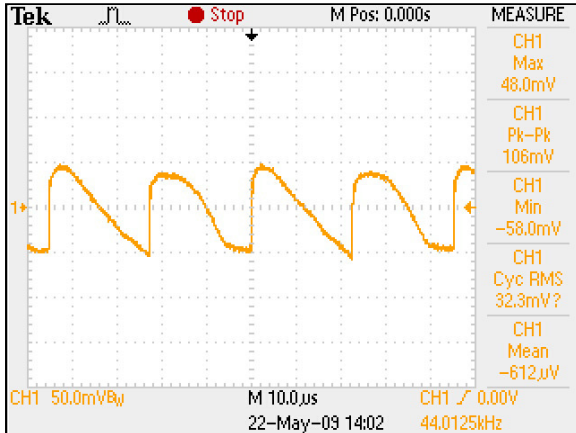

## ADNB064-15-1PM-C Performance – Curves

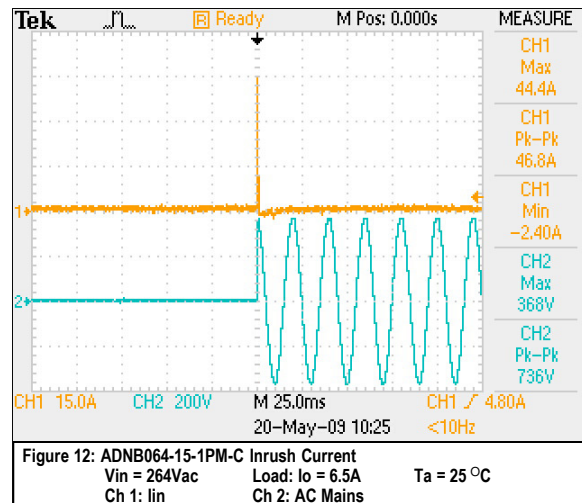
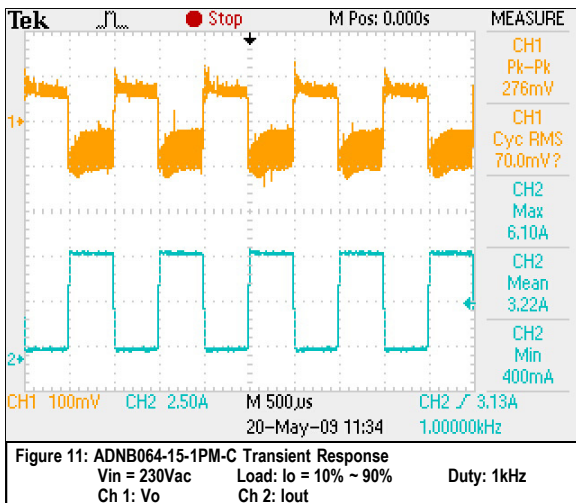
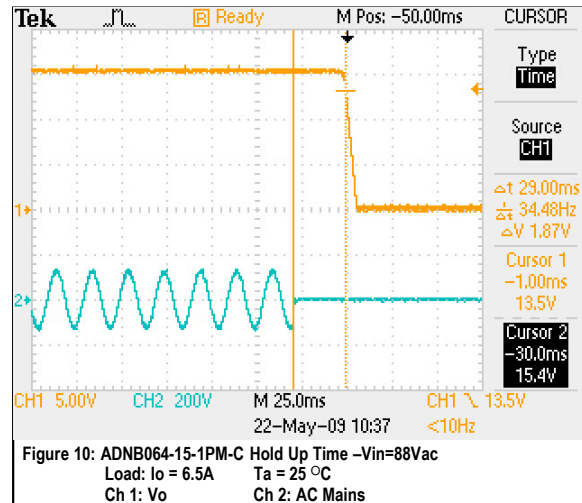
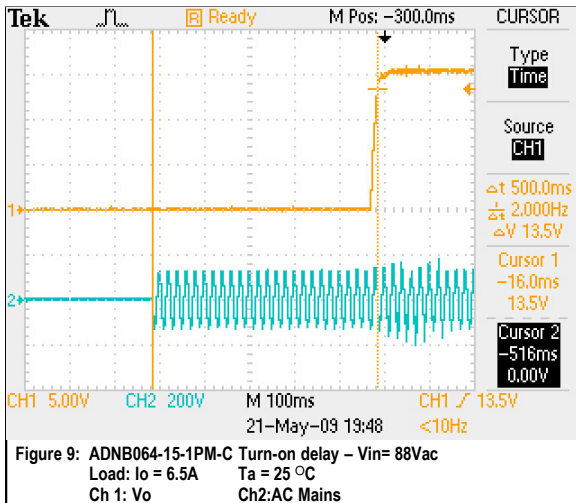
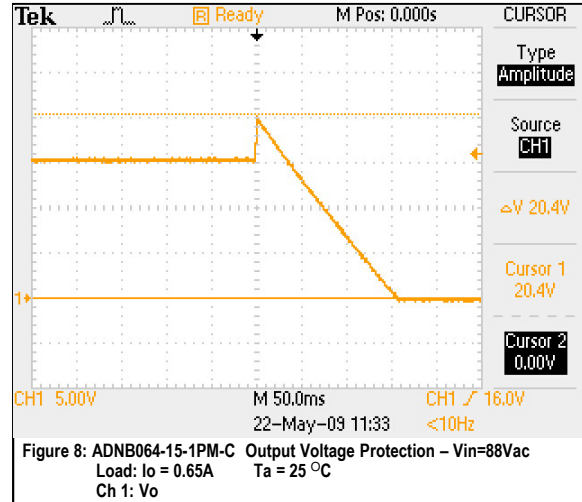
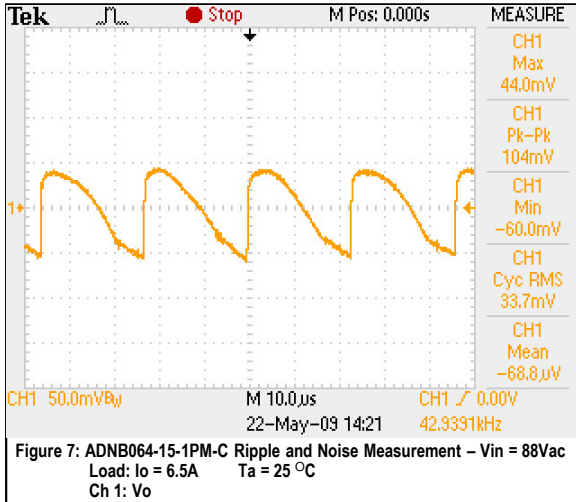

## ADNB040-24-1PM-C Performance Curves

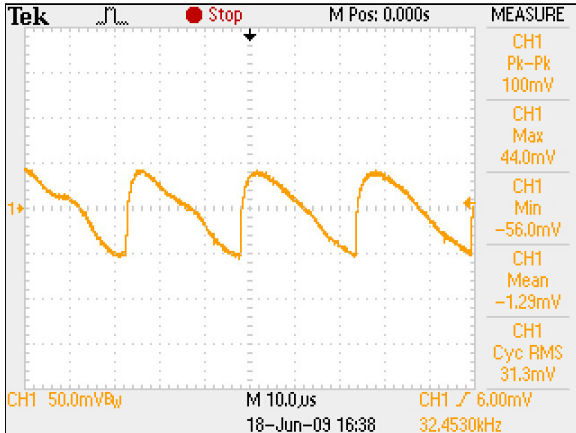

Figure 13: ADNB040-24-1PM-C Ripple and Noise Measurement – Vin = 88Vac  
Load: Io = 4.0A Ta = 25 °C  
Ch 1: Vo

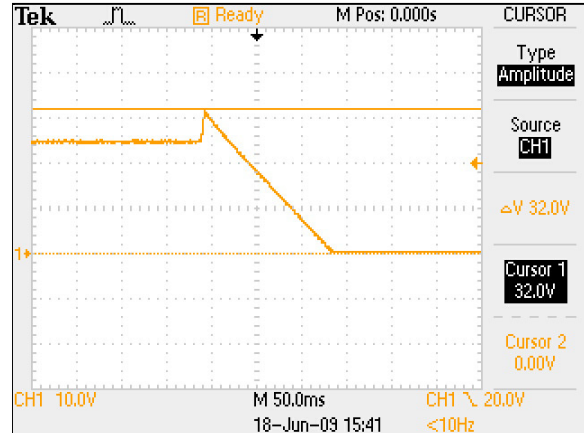

Figure 14: ADNB040-24-1PM-C Output Voltage Protection – Vin=88Vac  
Load: Io = 0.4A Ta = 25 °C  
Ch 1: Vo

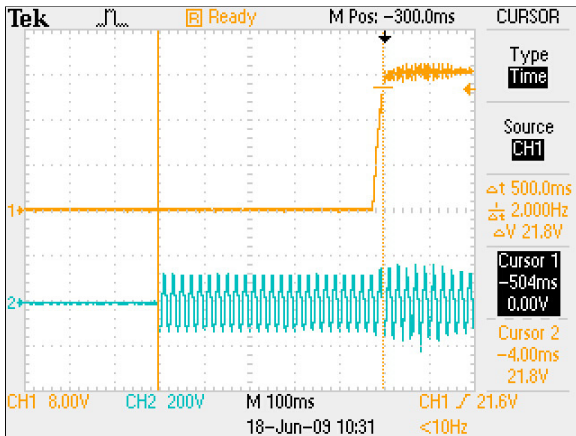

Figure 15: ADNB040-24-1PM-C Turn-on delay – Vin= 88Vac  
Load: Io = 4.0A Ta = 25 °C  
Ch 1: Vo Ch2:AC Mains

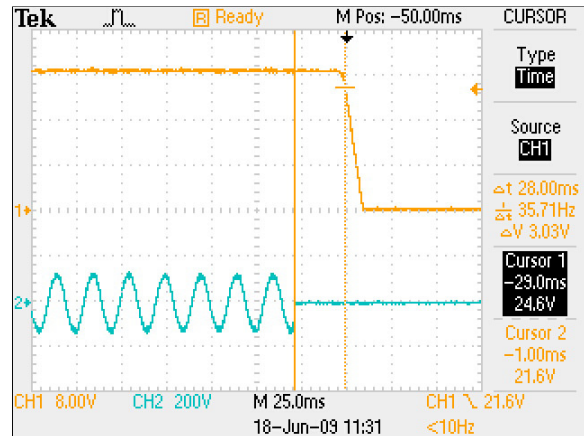

Figure 16: ADNB040-24-1PM-C Hold Up Time –Vin=88Vac  
Load: Io = 4.0A Ta = 25 °C  
Ch 1: Vo Ch 2: AC Mains

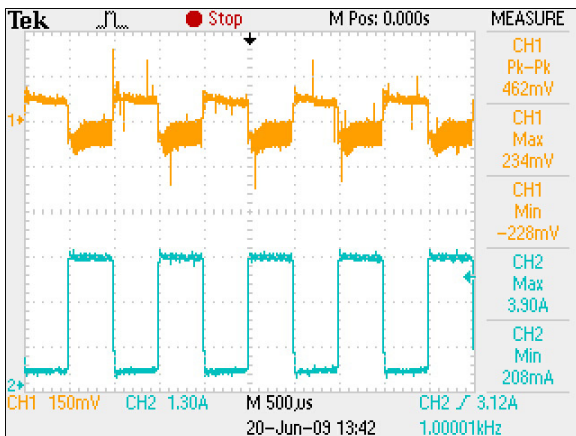

Figure 17: ADNB040-24-1PM-C Transient Response  
Vin = 230Vac Load: Io = 10% ~ 90% Duty: 1kHz  
Ch 1: Vo Ch 2: Iout

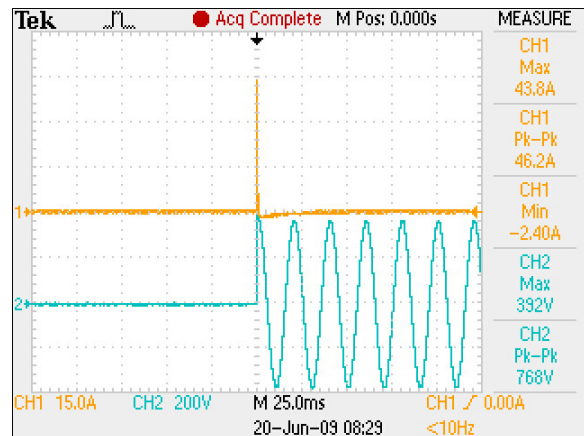
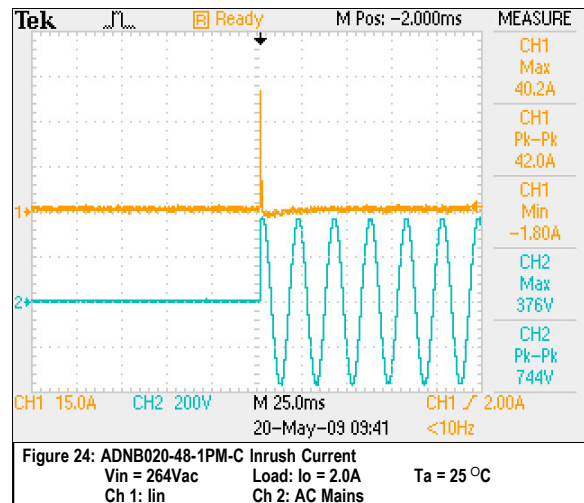
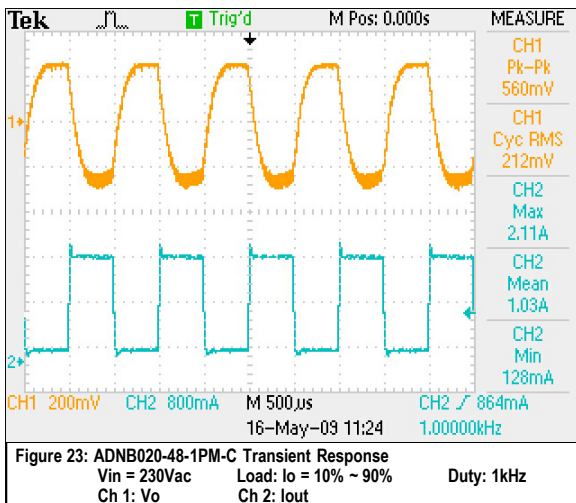
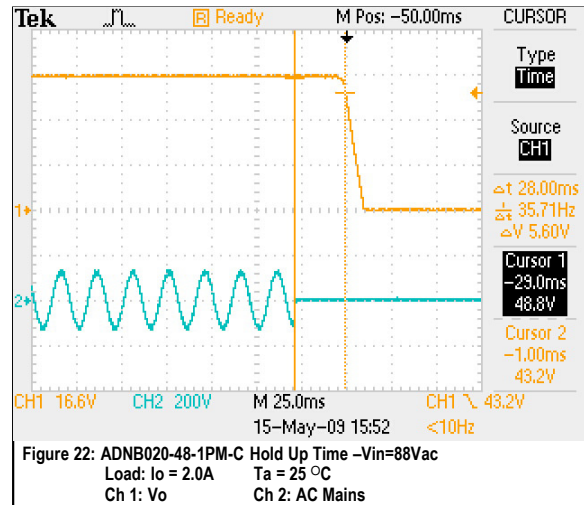
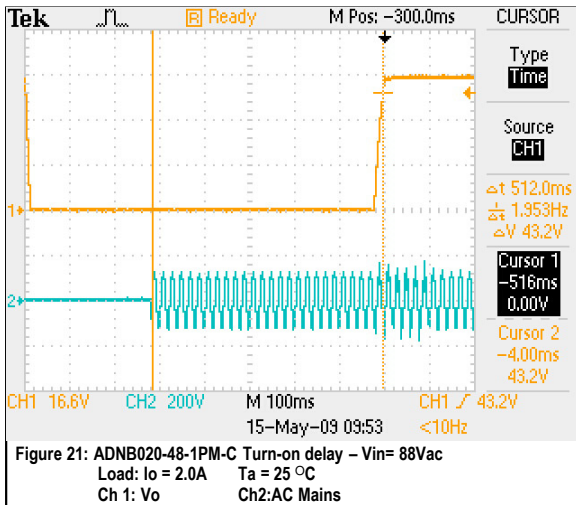
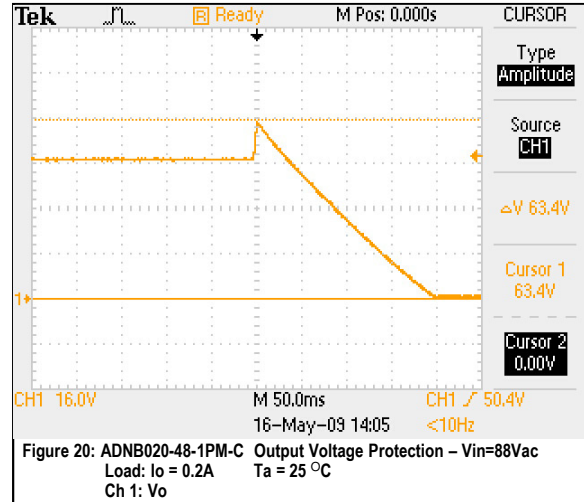
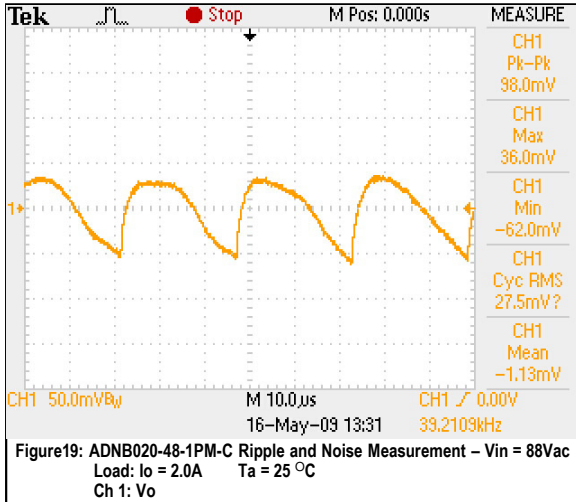

Figure 18: ADNB040-24-1PM-C Inrush Current  
Vin = 264Vac Load: Io = 1.7A Ta = 25 °C  
Ch 1: Iin Ch 2: AC Mains



## ADNB020-48-1PM-C Performance Curves



## Protective Function Specifications

### Over Voltage Protection (OVP)

The power supply output voltage latches off during output overvoltage with the AC line recycled to reset the latch.

#### ADNB075-12-1PM-C

Parameter	Min	Nom	Max	Unit
12V Vo Output Overvoltage	13.8	/	18	V

#### ADNB064-15-1PM-C

Parameter	Min	Nom	Max	Unit
15V Vo Output Overvoltage	17.25	/	22.5	V

#### ADNB040-24-1PM-C

Parameter	Min	Nom	Max	Unit
24V Vo Output Overvoltage	27.6	/	36	V

#### ADNB020-48-1PM-C

Parameter	Min	Nom	Max	Unit
48V Vo Output Overvoltage	55.2	/	72	V

## Over Current Protection (OCP)

ADNB 96W series power supply includes internal current limit circuitry to prevent damage in the event of overload or short circuit. In the event of overloads, it will go to hiccup mode, the output voltage may deviate from the regulation band but recovery is automatic when the load is reduced to within specified limits.

### **ADNB075-12-1PM-C**

Parameter	Min	Nom	Max	Unit
12V Vo Output Overcurrent	7.65	/	/	A

### **ADNB064-15-1PM-C**

Parameter	Min	Nom	Max	Unit
15V Vo Output Overcurrent	6.528	/	/	A

### **ADNB040-24-1PM-C**

Parameter	Min	Nom	Max	Unit
24V Vo Output Overcurrent	4.08	/	/	A

### **ADNB020-48-1PM-C**

Parameter	Min	Nom	Max	Unit
48V Vo Output Overcurrent	2.04	/	/	A

## Mechanical Specifications

### Mechanical Drawing (Dimensioning and Mounting Locations)

Unit : mm / inch

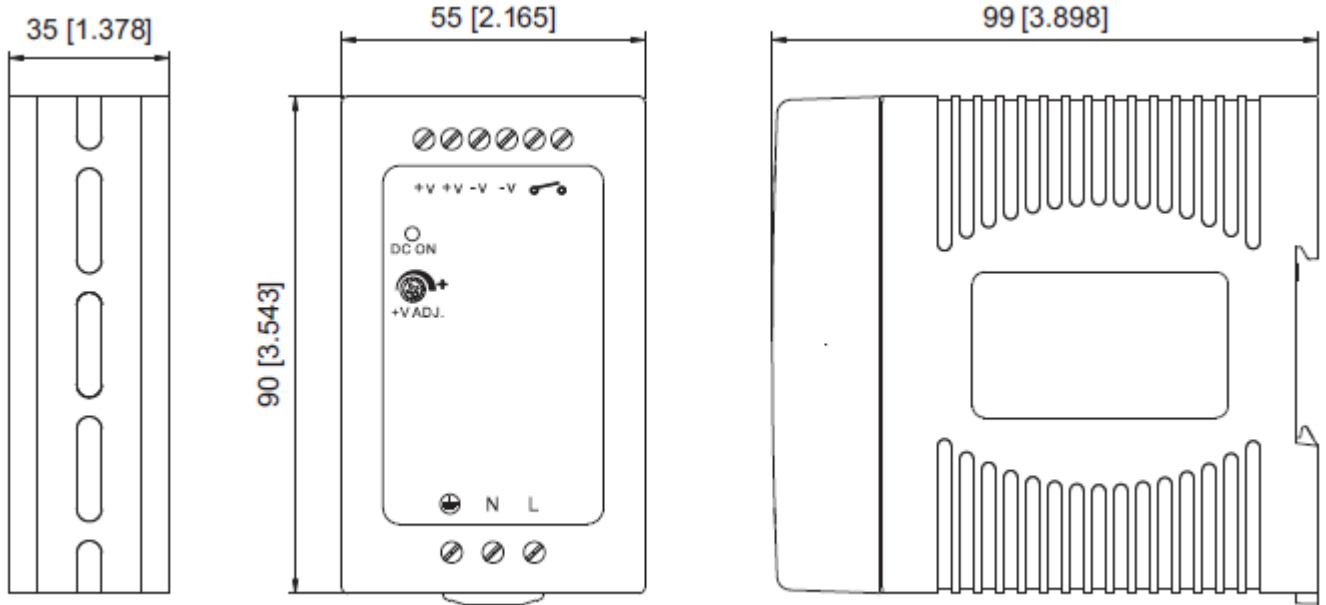

install DIN rail TS-35 / 7.5 or TS-35 / 15

### **Weight**

The ADNB 96W series packing weight is 0.882lb/400g typical.

## Environmental Specifications

### EMC Immunity

ADNB 96W series power supply is designed to meet the following EMC immunity specifications:

Table 4. Environmental Specifications:

Document	Description
EN 55022	Conducted Level B and Radiated Level B (stand alone)
EN 61000-3-2	Harmonic Distortion
EN 61000-3-3	Harmonic Distortion
EN 61204-3	EMS immunity
EN 55024	EMS immunity

## Safety Certifications

The ADNB 96W series power supply is intended for inclusion in other equipment and the installer must ensure that it is in compliance with all the requirements of the end application. This product is only for inclusion by professional installers within other equipment and must not be operated as a stand alone product.

Table 5. Safety Certifications for ADNB 96W series power supply system:

Document	Description
UL/cUL508/UL1310	US and Canada Requirements
TUV EN60950-1	Germany and European Requirements (All CENELEC Countries)

## **EMI Emissions**

The ADNB 96W series has been designed to comply with the Class B limits of EMI requirements of EN55022 (FCC Part 15) and CISPR 22 (EN55022) for emissions and relevant sections of EN61000 (IEC 61000) for immunity.

The unit is enclosed inside a metal box, tested at full load using resistive load.

## **Conducted Emissions**

The applicable standard for conducted emissions is EN55022 (FCC Part 15). Conducted noise can appear as both differential mode and common mode noise currents. Differential mode noise is measured between the two input lines, with the major components occurring at the supply fundamental switching frequency and its harmonics. Common mode noise, a contributor to both radiated emissions and input conducted emissions, is measured between the input lines and system ground and can be broadband in nature.

Table 6. Conducted EMI emission specifications of the ADNB 96W series

<b>Parameter</b>	<b>Model</b>	<b>Symbol</b>	<b>Min</b>	<b>Typ</b>	<b>Max</b>	<b>Unit</b>
FCC Part 15, class B	All	Margin	-	-	6	dB
CISPR 22 (EN55022) class B	All	Margin	-	-	6	dB



### **Radiated Emissions**

Unlike conducted EMI, radiated EMI performance in a system environment may differ drastically from that in a stand-alone power supply. It is thus recommended that radiated EMI be evaluated in a system environment. The applicable standard is EN55022 Class B (FCC Part 15). Testing ac-dc converters as a stand-alone component to the exact requirements of EN55022 can be difficult, because the standard calls for 1m leads to be attached to the input and outputs and aligned such as to maximize the disturbance. In such a set-up, it is possible to form a perfect dipole antenna that very few ac-dc converters could pass. However, the standard also states that 'an attempt should be made to maximize the disturbance consistent with the typical application by varying the configuration of the test sample'.

## Operating Temperature

The ADNB 96W series start and operate within stated specifications at an ambient temperature from  $-25^{\circ}\text{C}$  to  $70^{\circ}\text{C}$  under all load conditions (see below derating curves for other amount of convection and orientation. Derate output current and power by 2.5% per degree above  $50^{\circ}\text{C}$ . Maximum operating ambient temperature is  $70^{\circ}\text{C}$  (which implies a 50% derating at max  $70^{\circ}\text{C}$  ambient).

Under convection cooling condition, the maximum output power derates linearly from full load. When input voltage is 90Vac, the maximum output power will derate to 90% full load.

## Derating Curve

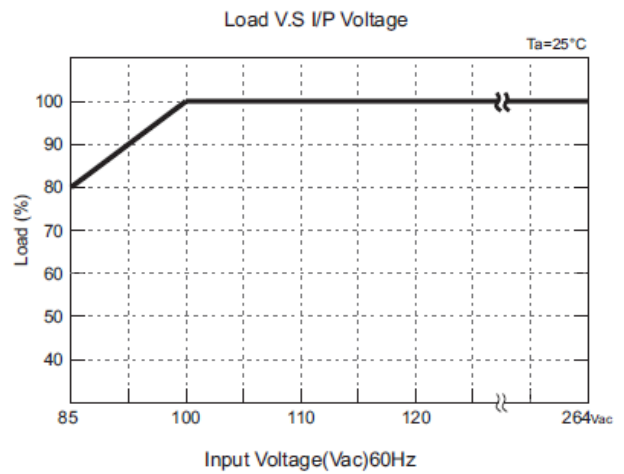
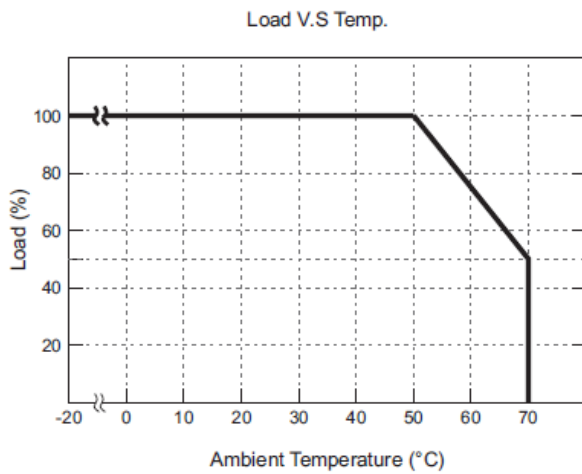

## Storage and Shipping Temperature / Humidity

The ADNB 96W series can be stored or shipped at temperatures between -40 °C to +85 °C and relative humidity from 10% to 95%, non-condensing.

## Humidity

The ADNB 96W series will operate within specifications when subjected to a relative humidity from 20% to 90% non-condensing. The ADNB 96W series can be stored in a relative humidity from 10% to 95% non-condensing.

## Vibration

The ADNB 96W series will pass the following vibration specifications:

Acceleration	2	gRMS
Frequency Range	10-500	Hz
Duration	10	mins
Direction	3 mutually perpendicular axis	
PSD Profile	<p><b>FREQ</b> 10-500 Hz</p>	<p><b>SLOPE</b> <b>dB/oct</b> ---</p>
		<p><b>PSD</b> <b>g<sup>2</sup>/Hz</b> ---</p>

## Application Notes

### Block Diagram

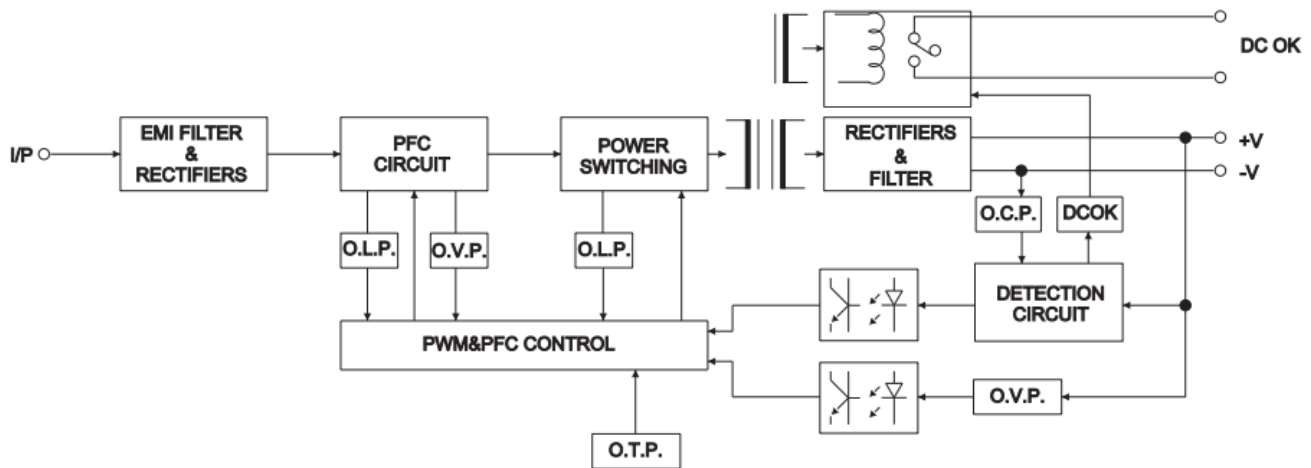

### DC OK Relay Contact

Contact Close	When the output voltage reaches the adjusted output voltage
Contact Open	When the output voltage drop below 90% output voltage
Contact Ratings(max.)	30V/1A resistive load

## Output Ripple and Noise Measurement

The setup outlined in the diagram below has been used for output voltage ripple and noise measurements on the ADNB 96W series . When measuring output ripple and noise, a scope jack in parallel with a 0.1uF ceramic chip capacitor, and a 47uF aluminum electrolytic capacitor should be used. Oscilloscope should be set to 20MHz bandwidth for this measurement.

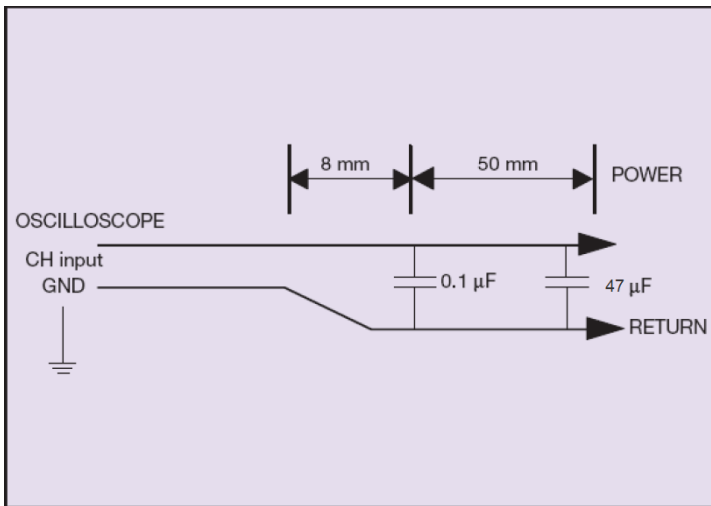

### WORLDWIDE OFFICES

#### Americas

2900 S.Diablo Way  
Tempe, AZ 85282  
USA  
+1 888 412 7832

#### Europe (UK)

Waterfront Business Park  
Merry Hill, Dudley  
West Midlands, DY5 1LX  
United Kingdom  
+44 (0) 1384 842 211

#### Asia (HK)

14/F, Lu Plaza  
2 Wing Yip Street  
Kwun Tong, Kowloon  
Hong Kong  
+852 2176 3333

**ARTESYN**<sup>™</sup>  
EMBEDDED TECHNOLOGIES

[www.artesyn.com](http://www.artesyn.com)

While every precaution has been taken to ensure accuracy and completeness in this literature, Artesyn Embedded Technologies assumes no responsibility, and disclaims all liability for damages resulting from use of this information or for any errors or omissions. Artesyn Embedded Technologies, Artesyn and the Artesyn Embedded Technologies logo are trademarks and service marks of Artesyn Technologies, Inc. All other names and logos referred to are trade names, trademarks, or registered trademarks of their respective owners.  
© 2014 All rights reserved.

For more information: [www.artesyn.com/power](http://www.artesyn.com/power)  
For support: [productsupport.ep@artesyn.com](mailto:productsupport.ep@artesyn.com)

## Record of Revision and Changes

Issue	Date	Description	Originators
1.0	04.19.2016	First Issue	E. Bai
1.2	11.02.2016	Updated the MTBF Value	K. Wang
1.3	11.22.2016	Updated the OCP mode	A. Zhang

### WORLDWIDE OFFICES

#### Americas

2900 S.Diablo Way  
Tempe, AZ 85282  
USA  
+1 888 412 7832

#### Europe (UK)

Waterfront Business Park  
Merry Hill, Dudley  
West Midlands, DY5 1LX  
United Kingdom  
+44 (0) 1384 842 211

#### Asia (HK)

14/F, Lu Plaza  
2 Wing Yip Street  
Kwun Tong, Kowloon  
Hong Kong  
+852 2176 3333



[www.artesyn.com](http://www.artesyn.com)

While every precaution has been taken to ensure accuracy and completeness in this literature, Artesyn Embedded Technologies assumes no responsibility, and disclaims all liability for damages resulting from use of this information or for any errors or omissions. Artesyn Embedded Technologies, Artesyn and the Artesyn Embedded Technologies logo are trademarks and service marks of Artesyn Technologies, Inc. All other names and logos referred to are trade names, trademarks, or registered trademarks of their respective owners.  
© 2014 All rights reserved.

For more information: [www.artesyn.com/power](http://www.artesyn.com/power)  
For support: [productsupport.ep@artesyn.com](mailto:productsupport.ep@artesyn.com)

## X-ON Electronics

Largest Supplier of Electrical and Electronic Components

*Click to view similar products for [DIN Rail Power Supplies](#) category:*

*Click to view products by [Artesyn Embedded Technologies](#) manufacturer:*

Other Similar products are found below :

[PS-S6024](#) [DVP01PU-S](#) [DVP06AD-S](#) [DVP06XA-S](#) [DVDPNET-SL](#) [DVPDT01-S](#) [DVPPS01](#) [PS-6012](#) [PS9Z-5R1G](#) [PS-C24024](#)  
[DVP08ST11N](#) [DVPACAB530](#) [DVPCOPM-SL](#) [DVPEN01-SL](#) [DVPPF01-S](#) [ADNB008-48-1PM-C](#) [ADNB017-24-1PM-C](#) [ADNB040-24-1PM-C](#) [ADNB034-12-1PM-C](#) [SS14011524](#) [PS-UPS40](#) [PSC-6024](#) [PSD-A60W12](#) [96PS-A120WDIN](#) [PSD-A60W48](#) [PSD-A40W12](#) [PSD-A40W24](#) [SMP21-L20-DC24V-5A](#) [PSD-A40W48](#) [S8T-DCBU-02](#) [PS-S4024](#) [NTPS-24-1.3](#) [ZI-20](#) [PST-96024](#) [S82YVSC4P](#) [PS-S4005](#) [PS-10024](#) [PS-S10024](#) [PS-C12024](#) [PSP-480S24](#) [PS-C48024](#) [PSC-2024](#) [PSC-4012](#) [PSC-4048](#) [PSC-9615](#) [PSC-15124](#) [PSC-15148](#) [PSC-24148](#) [PSC-48148](#) [TRIO-PS-2G/1AC/12DC/5/C2LP](#)