

COMX-CORE Series

COM Express Modules

■ Embedded Computing for
Business-Critical Continuity™

Type 6 COM Express modules are designed to provide standard PC processing functionality for high performance applications

- Intel® Core™ i5 and i7 processors at up to 2.4 GHz
- Intel® Celeron® P4505 processor at 1.86 GHz
- Up to 8GB DDR3 memory, with ECC option
- Gigabit Ethernet, SATA and USB ports
- Dual graphics outputs
- Multiple PCI Express lanes for high speed expansion

The COMX-CORE series of COM Express® modules are based on the new Intel® Core™ i5 and i7 mobile processors for high performance applications. These new processors are especially suitable for embedded applications due to their improved performance/power ratio and small form factor. This Type 6 COM Express module provides state-of-the-art PC functionality and is designed to be plugged onto a custom carrier board to create an application-specific solution. Already widely adopted in the industrial automation and medical markets, this latest COM Express module incorporates new functionality for improved security and management.

The COMX-CORE modules use the latest generation Unified Extensible Firmware Interface (UEFI) BIOS from AMI. This manages the interaction between the low-level hardware interfaces and the OS level in a clean and efficient way that is expected to provide superior reliability, especially considering the flexibility for user I/O and option ROM on custom baseboards.

COMX-CORE modules have a wide range of interfaces to connect to standard peripherals directly or to carrier mounted I/O. These include LCD and CRT displays, SATA and USB flash disks, PCI Express devices, USB and Gigabit Ethernet networks. Obviously some of the target applications are in locations not well suited to physical disk support and so in addition to SATA disk support, COMX-CORE modules also have the capability to use and boot from an optional eUSB flash disk, available up to 16Gb capacity.

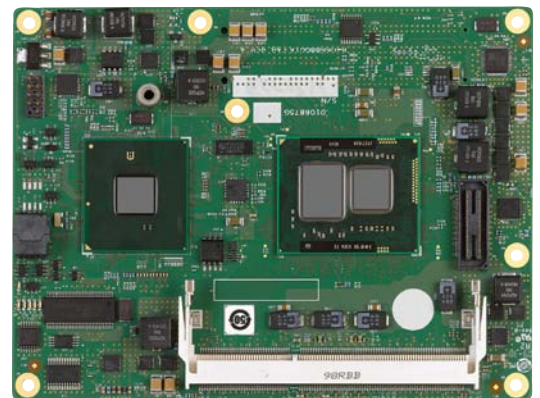
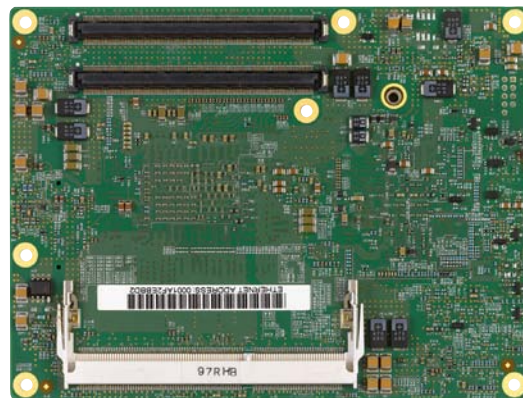

Block Diagram

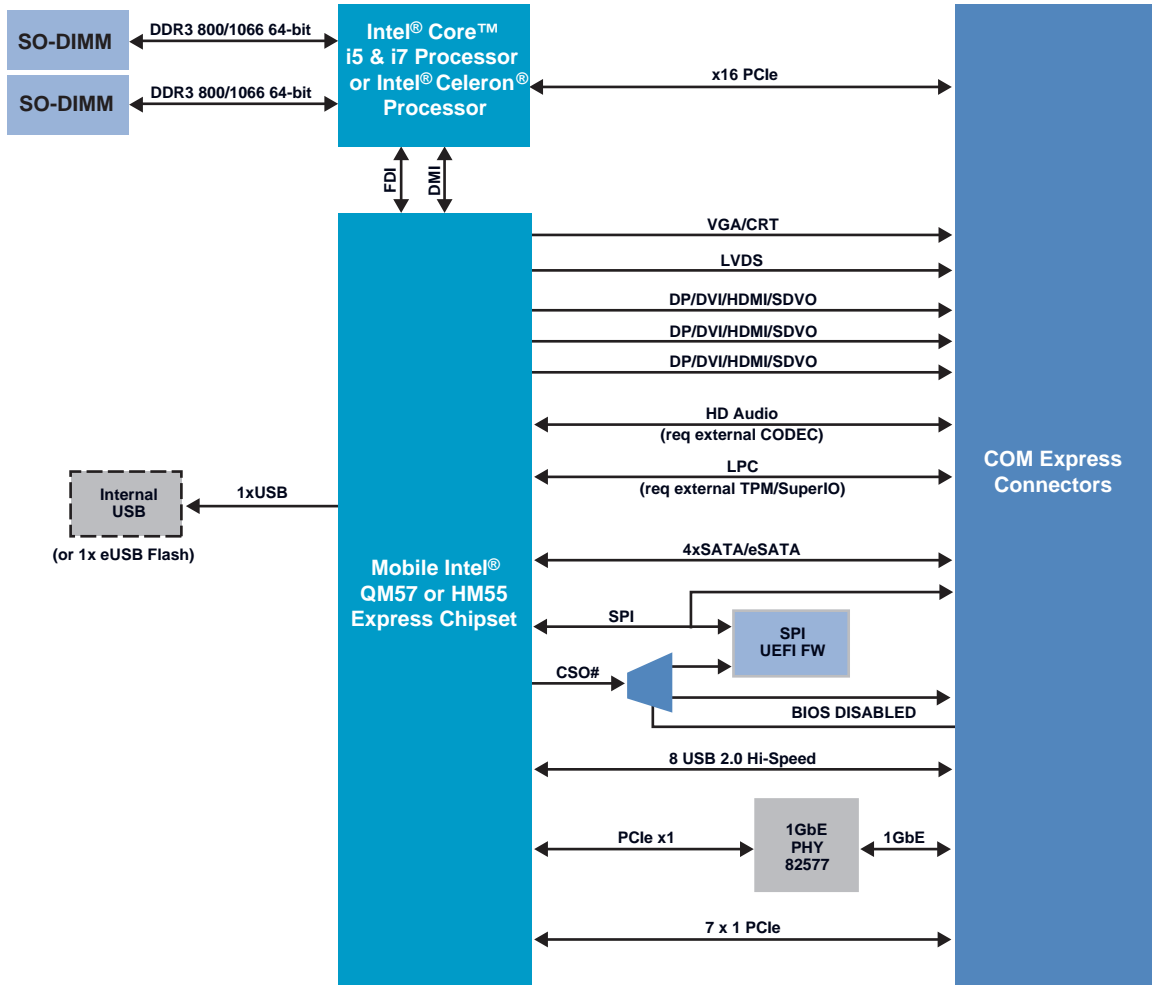

Hardware Specifications

PROCESSOR

- Intel® Core i7 dual-core up to 2.0 GHz
- Intel® Core i5 dual-core up to 2.4 GHz
- Intel® Celeron® P4505 @ 1.86 GHz

CHIPSET

- Mobile Intel® QM57 Express
- Mobile Intel® HM55 Express

MEMORY

- Two DDR3 800/1066 64-bit SO-DIMM sockets. Maximum memory capacity is 8GB. Option for ECC memory.

VIDEO

- 200 MHz graphics engine
- Next-generation graphics core offering superior 3D and video performance
- Includes hardware acceleration for AVC/VC-1/MPEG-2

BUS EXPANSION

- (7) PCI Express x 1
- (1) PCI Express x 16

I/O

- (1) Gigabit Ethernet (Intel® 82577)
- (4) SATA
- (8) USB 2.0
- HD Audio (requires external codec)
- LPC for external TPM
- SPI for external BIOS

COMPLIANCE AND CERTIFICATION INFORMATION

- EMC and Safety
 - ▲ Class B (FCC, VCCI, MIC, AS/NZ)
 - ▲ UL, CSA, Ctick

Firmware and Operating System Support

BIOS

- AMI UEFI BIOS

OS COMPATIBILITY

- Microsoft® Windows® XP,
- Microsoft Windows Vista®
- Fedora Core 12

Package Contents

- (1) COM Express Motherboard
- (1) Drivers CD

Ordering Information	
Part Number	Description
COMX-CORE-750	COM Express module with Intel Core i7 processor @ 2.0 GHz
COMX-CORE-710	COM Express module with Intel Core i7 processor @ 1.066 GHz
COMX-CORE-512	COM Express module with Intel Core i5 processor @ 2.4 GHz, supports ECC memory
COMX-CORE-510	COM Express module with Intel Core i5 processor @ 2.4 GHz
COMX-CORE-312	COM Express module with Intel Celeron P4505 processor @ 1.86 GHz, supports ECC memory
COMX-CORE-310	COM Express module with Intel Celeron P4505 processor @ 1.86 GHz
Accessories	
COMX-CORE-HP	Heat spreading plate
COMX-CORE-HTSNK	Active heatsink
COMX-CORE-510-KIT	Developers kit containing 510, heatsink, memory and carrier board













SOLUTION SERVICES

Emerson Network Power provides a portfolio of solution services optimized to meet your needs throughout the product lifecycle. Design services help speed time-to-market. Deployment services include global 24x7 technical support. Renewal services enable product longevity and technology refresh.

Intel and Core are trademarks of Intel Corporation or its subsidiaries in the United States and other countries. Microsoft, Windows and Vista are trademarks of Microsoft Corporation. All other product or service names are the property of their respective owners.

This document identifies products, their specifications, and their characteristics, which may be suitable for certain applications. It does not constitute an offer to sell or a commitment of present or future availability, and should not be relied upon to state the terms and conditions, including warranties and disclaimers thereof, on which Emerson Network Power may sell products. A prospective buyer should exercise its own independent judgment to confirm the suitability of the products for particular applications. Emerson Network Power reserves the right to make changes, without notice, to any products or information herein which will, in its sole discretion, improve reliability, function, or design. Emerson Network Power does not assume any liability arising out of the application or use of any product or circuit described herein; neither does it convey any license under its patent or other intellectual property rights or under others. This disclaimer extends to any prospective buyer, and it includes Emerson Network Power's licensee, licensee's transferees, and licensee's customers and users. Availability of some of the products and services described herein may be restricted in some locations.

Emerson Network Power.
The global leader in enabling
Business-Critical Continuity™.

-  AC Power
-  Embedded Power
-  Precision Cooling
-  Connectivity
-  Infrastructure Management & Monitoring
-  Racks & Integrated Cabinets
-  DC Power
-  Outside Plant
-  Services
-  Embedded Computing
-  Power Switching & Controls
-  Surge Protection

Emerson Network Power

Offices: Tempe, AZ U.S.A. 1 800 759 1107 or +1 602 438 5720
 Paris, France +33 1 60 92 31 20 • Munich, Germany +44 1509 236490 • Tel Aviv, Israel +972 99560361
 Hong Kong +852 2176 3540 • Shanghai, China +86 21 3395 0289 • Tokyo, Japan +81 3 5403 2730 • Seoul, Korea +82 2 3483 1500

EmersonNetworkPower.com/EmbeddedComputing

Emerson, Business-Critical Continuity and Emerson Network Power are trademarks of Emerson Electric Co. or one of its affiliated companies. ©2011 Emerson Electric Co.

X-ON Electronics

Largest Supplier of Electrical and Electronic Components

Click to view similar products for [System-On-Modules - SOM category](#):

Click to view products by [Artesyn Embedded Technologies manufacturer](#):

Other Similar products are found below :

[PICOIMX6S10R512NI4GBW](#) [20-101-1067](#) [20-101-1068](#) [PICOIMX6S10R512SD](#) [COMX-CORE-310](#) [CC-9P-V513-C](#) [Nit6Q_2GB](#) [COMX-P4040-4G-ENP2](#) [PICOIMX6U10R1GBNI4G](#) [PICOIMX6U10R1GBNI4GBW](#) [SOM-5897C7-U8A1E](#) [SOM-5897C7-U0A1E](#) [Nit6D_SOM_v2](#) [20-101-0079](#) [RM-F6SO1-SMC](#) [SOM-RK3399-Q7-2.1-I-4096M-32G-CAN](#) [MC27561-TIGER](#) [MC27561-LION](#) [AM335XBBLK-SYSTEM](#) [BD63715AEFV-EVK-001](#) [MC27561-FOX](#) [CC-WMX6UL-SMPL](#) [CB-52-PUS-110-SX](#) [BD63725BEFV-EVK-002](#) [BD63521EFV-EVK-001](#) [BD63525AEFV-EVK-001](#) [BD63511EFV-EVK-001](#) [BD63725BEFV-EVK-001](#) [EDI1.SPON.AL.S 937637](#) [SOM-6898C3Z2-U4A1E](#) [MYD-C4378-4E512D-100-I](#) [Q7M311-N4200-4GB](#) [PICOIMX8MMQ18R40E16](#) [A00150](#) [TE0745-02-81C11-A](#) [TE0714-03-35-2I](#) [TE0791-01](#) [00151100](#) [100-1215-1](#) [EIC-Q410-200](#) [COMX_P4080](#) [CC-ACC-LCDW-10](#) [20-101-0081](#) [151-0096](#) [SIP-005AYS001](#) [BS2P24](#) [BS2P40](#) [BS2PE](#) [RK3188-SOM](#) [RK3188-SOM-4GB](#)