

# ARTESYN LCM4000HV/LCM12K

4000 Watts Bulk Front End/12 kWatts Power Shelf  
Centralized Power for LED Horticulture Lighting



Advanced Energy's Artesyn LCM4000HV series and associated LCM12K mounting shelf has been designed specifically to provide a centralized current source for medium to large scale LED lighting and horticulture applications. The unique input design allows all standard AC inputs 208 VAC to 600 VAC from single to 3 phase sources. The output of each 4 kW block provides flicker free current source from 0 to 16 A at an output voltage range between 100 VDC to 300 VDC. High nominal operating voltage provides the benefits of lower cost standard wiring and higher efficiency with minimal voltage drop over long distance.

The convenient 19" 1U rack mount shelf is designed for hot plug replacement of the 4 kW modules insuring the highest reliability and simplest maintenance possible. For large systems stacking 10 shelves in a short 10U cabinet would provide 120 kW for a normal sized grow area.

## SPECIAL FEATURES

- Wide input voltage range
  - High efficiency: up to 95%
  - Industrial safety
  - Five-year warranty
  - Low cost
  - Digital and analog communication
  - Scales easily (Module/Shelf/Rack)
  - Meets DLC 2.1 requirements
  - Supports Artesyn iTS and IHLC
- LCM12K:
- Accepts 3 types of input configurations (3-PH delta 4W, 3-PH wye 4W, 3-PH wye 5 W)
  - Houses three 4 kW power modules
  - 446.3 mm x 504.3 mm x 43.7 mm

## AT A GLANCE

### Total Power

LCM4000HV: 4000 Watts  
LCM12K: 12 kWatts

### Input Voltage

LCM4000HV: Single Phase  
187 to 264 VAC  
311 to 528 VAC

LCM12K: Three Phase  
187 to 229 VAC  
342 to 528 VAC  
540 to 660 VAC (WYE with Neutral)

### Output

LCM4000HV:  
Voltage source: 100 to 300 VDC  
Current source: 0 to 16 A

## COMPLIANCE

- EMI Class A
- EN61000 Immunity
- RoHS 3

## SAFETY

- UL 62368-1 Listed
- CSA 62368-1 Listed
- EN 62368-1 Listed
- IEC 62368-1 Listed
- CB Certificate and Report (IEC 62368-1/IEC 60950-1)
- CE (LVD+RoHS)

APPLICATIONS

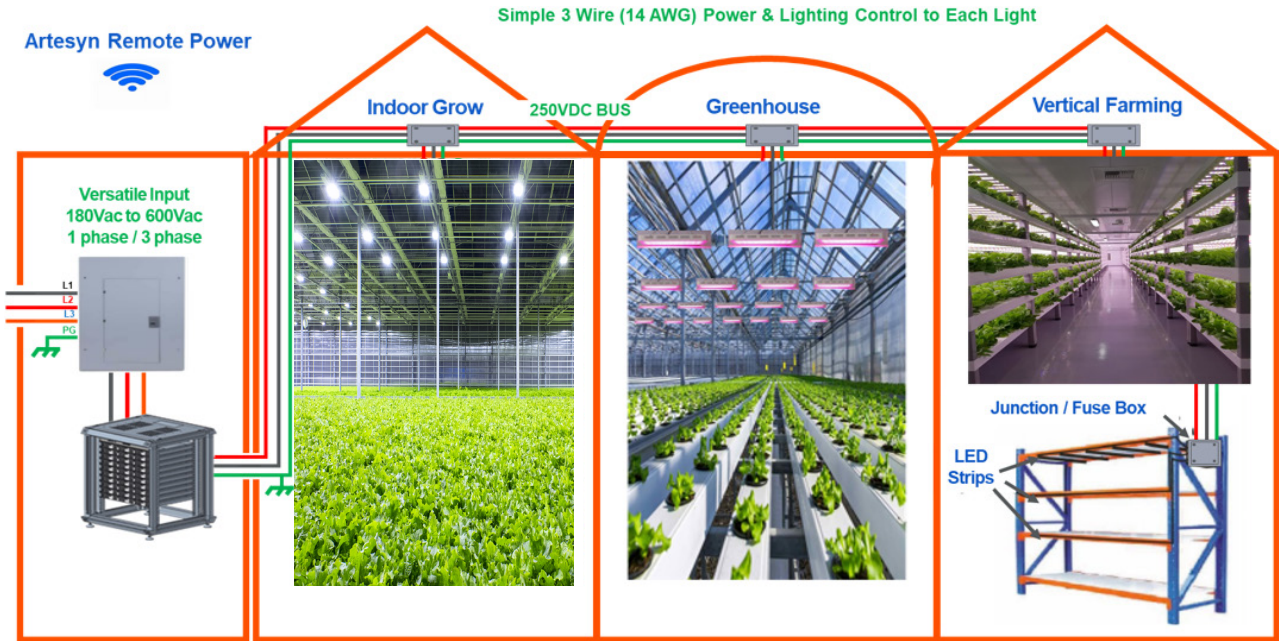

Retail Store LED Lighting

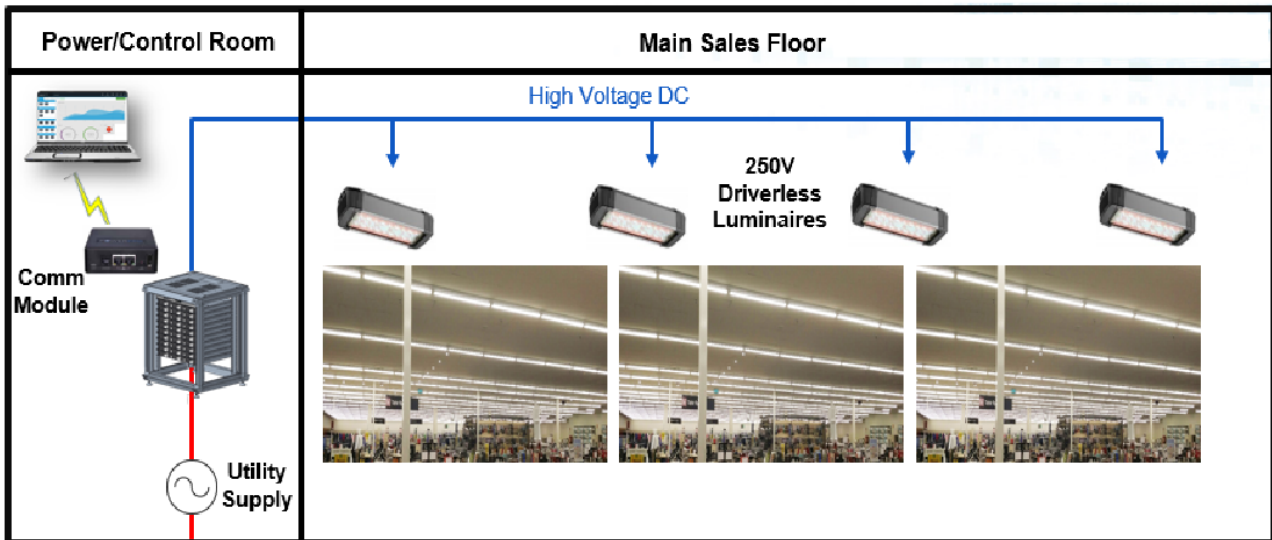

**ELECTRICAL SPECIFICATIONS**

Input - LCM4000HV	
Input range <sup>1</sup>	187 to 264 VAC 311 to 528 VAC
Frequency	47 to 63 Hz, Nominal 50/60 Hz
Input fusing	Both lines fused
Inrush current	< 60 A peak at 264 VAC, < 60 A peak at 528 VAC
Power factor	0.98 at 100% load, at 208 VAC input 0.97 at 100% load, at 480 VAC input
Harmonics	Meets IEC 61000-3-12 requirements
Input current	25 A max at 180 VAC
No load power	35 W max at 180 VAC
Efficiency	94.0% typical
Leakage current	< 5 mA at 264/528 VAC, 60 Hz
Isolation voltage	Primary to protective earth (PE) = 4000 VDC Primary to secondary = 4000 VDC Secondary to protective earth (PE) = 3200 VDC Primary to user-accessible = 6000 VDC Secondary to user-accessible = 5000 VDC
Input - LCM12K	
Input range <sup>1</sup>	187 to 229 VAC (3-PH 4W) 342 to 528 VAC (3-PH 4W. Add Neutral for 600 VAC)
Input current	45 A max per phase at 187 VAC 25 A max per phase at 342 VAC

Note 1 - Detailed input specifications please refer to ordering information section.

**ELECTRICAL SPECIFICATIONS**

LCM4000HV Output - Module In Voltage Source Mode		
Nominal output voltage	250 VDC	
Maximum output current	16 A	
Maximum output power	4000 W	
Output voltage adjustability range	100 VDC to 300 VDC	
Output voltage adjustment accuracy	±0.5% of nominal output (via digital command) ±1% of nominal output (via analog command)	Ambient temperature at 23 °C ± 5 °C (with 30 minutes warm-up period)
Output static regulation <sup>1</sup>	0.5% of nominal output (line regulation) 0.75% of nominal output (load regulation)	Ambient temperature at 23 °C ± 5 °C (with 30 minutes warm-up period)
Line transient regulation <sup>2,3</sup>	±3% of nominal output voltage	Recovery time of 1 ms at recovery value of 0.5% of nominal output voltage
Load transient regulation <sup>2</sup>	±5% of nominal output voltage	Load transient at 50 Hz to 5 kHz, duty cycle 10% to 90%, 1 A/us, 50% step load change
Output voltage transient regulation <sup>2,4</sup>	±5% of nominal output voltage	Recovery time of 1 ms at recovery value of 0.5% of nominal output voltage
Output ripple & noise (peak to peak)	0.5% of nominal output voltage	Measured with 0.1 µF ceramic and 10 µF tantalum capacitor on any output, 20 MHz, at 25 °C
Output voltage overshoot & undershoot <sup>5</sup>	±5% of nominal output voltage ±1% of nominal output voltage	Output current equal or less than 1.6 A Output current more than 1.6 A
Max output capacitance	600 µF	
Output voltage rise time	80 ms maximum	Ramp of main output voltage from 0% to 100% of its final setpoint within the regulation band, under any load condition
Hold-up time	10 ms minimum	Tested at nominal output voltage, maximum output current
Overvoltage protection (OVP)	First level: 125% of voltage set-point, Secondary level: 130% of max output voltage	Latch Latch
Overload protection (OCP)	First level: constant current clamp (adjustable up to 104% of maximum output current) Second level: fast latch (set at 115% of maximum output current)	Auto-recovery Latch
Over temperature protection (OTP)	Over temperature protected	Auto-recovery
Short circuit protection	Short circuit protected	
LCM12K Output - Module In Voltage Source Mode		
Maximum output current	48 A (16A per PSU)	
Maximum output power	12 kW	

Note 1 - Operate at steady state line and load conditions.

Note 2 - Minimum dynamic load 1.6 A, maximum test capacitance 470 µF.

Note 3 - Line transient change at ±10%.

Note 4 - Occur during an on-the-fly adjustment of output voltage set-point. Slew rate at 4 V/ms.

Note 5 - Recover within 300 ms, rise is monotonic.

**ELECTRICAL SPECIFICATIONS**

LCM4000HV Output - Module In Current Source Mode		
Maximum output current	16 A	
Output voltage range	100 VDC to 300 VDC	
Maximum output power	4000 W	LCM4000HV
Output current adjustability range	0.48 A to 16 A	Less than 0.48A will be considered as 0A or OFF
Output current adjustment accuracy	±2% of max output current (via digital command) ±2.5% of max output current (via analog command)	Ambient temperature at 23 °C ± 5 °C (with 30 minutes warm-up period)
Output static regulation <sup>1</sup>	1% of max output current (line regulation) 2.5% of max output current (load regulation)	Ambient temperature at 23 °C ± 5 °C (with 30 minutes warm-up period)
Line transient regulation <sup>2,3</sup>	±3% of max output current	Recovery time of 1 ms at recovery value of 0.5% of max output current
Output current transient regulation <sup>2,4</sup>	±5% of max output current	Recovery time of 1 ms at recovery value of 0.5% of nominal output voltage
Output ripple & noise (RMS)	3.5% of maximum output current	Measured with 0.1 µF ceramic and 10 µF tantalum capacitor on any output, 20 MHz
Output current overshoot & undershoot <sup>5</sup>	±1% of nominal output current	Output voltage 100V and above
Max output capacitance	600 µF	
Output current rise time	80 ms maximum	Ramp of main output voltage from 0% to 100% of its final setpoint within the regulation band, under any load condition
Hold-up time	10 ms minimum	Tested at nominal output voltage, maximum output current
Overvoltage protection (OVP)	First level: constant voltage clamp (adjustable up to 120% of nominal output voltage)	Auto-recovery
	Second level: fast latch (set at 135% of nominal output voltage)	Latch
Overload protection (OCP)	First level: 115% of current set-point	Latch
	Secondary level: 120% of max output current	Latch
Over temperature protection (OTP)	Over temperature protected	Auto-recovery
Short circuit protection	Short circuit protected	
LCM12K Output - Module In Current Source Mode		
Maximum output current	48 A (16 A per PSU)	
Maximum output power	12 kW	

Note 1 - Operate at steady state line and load conditions.

Note 2 - Minimum dynamic load is equivalent to 40% of nominal output voltage, maximum test capacitance 470 µF.

Note 3 - Line transient change at ±10%.

Note 4 - Occur during an on-the-fly adjustment of output current set-point. Slew rate at 4% of I<sub>out-max</sub> per ms.

Note 5 - Recover within 300 ms, rise is monotonic.

ELECTRICAL SPECIFICATIONS

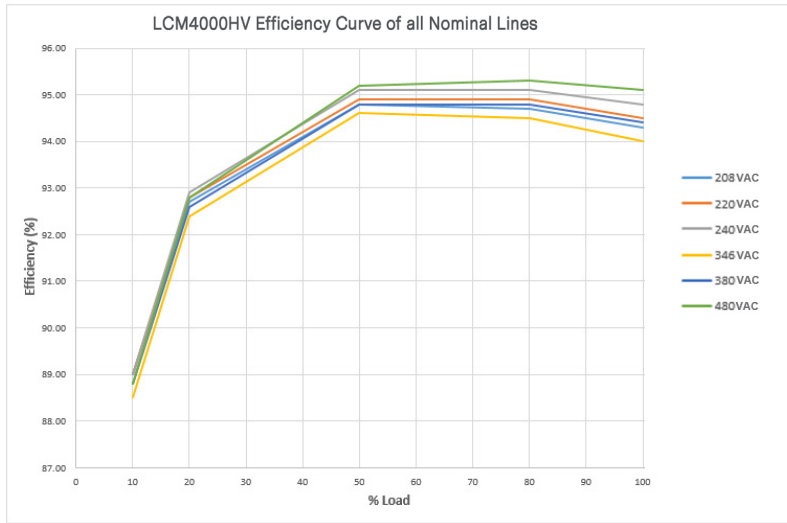

Load %	Efficiency (%)					
	208 VAC	220 VAC	240 VAC	346 VAC	380 VAC	480 VAC
10	89.00	89.00	89.00	88.50	88.80	88.80
20	92.70	92.80	92.90	92.40	92.60	92.80
50	94.80	94.90	95.10	94.60	94.80	95.20
80	94.70	94.90	95.10	94.50	94.80	95.30
100	94.30	94.50	94.80	94.00	94.40	95.10

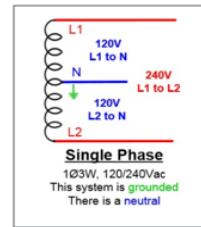
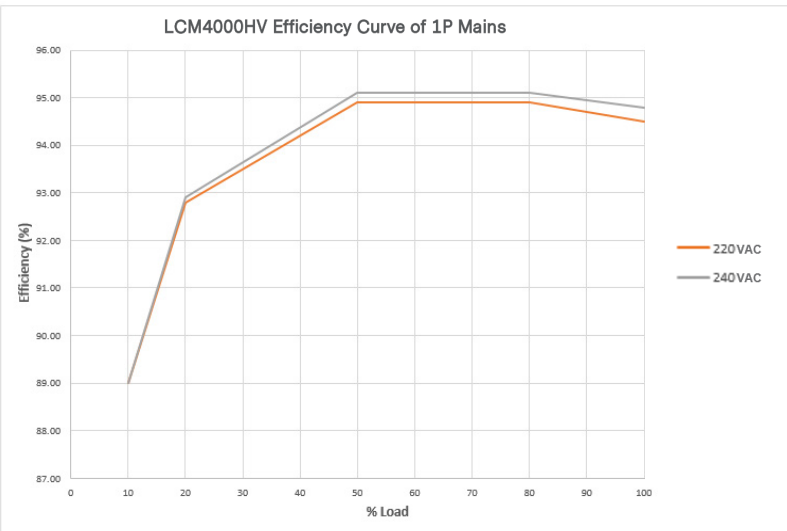

- 220 VAC (nominal)
- 240 VAC (nominal)

Load %	Efficiency (%)	
	220 VAC	240 VAC
10	89.00	89.00
20	92.80	92.90
50	94.90	95.10
80	94.90	95.10
100	94.50	94.80

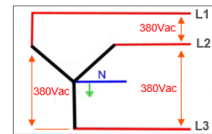
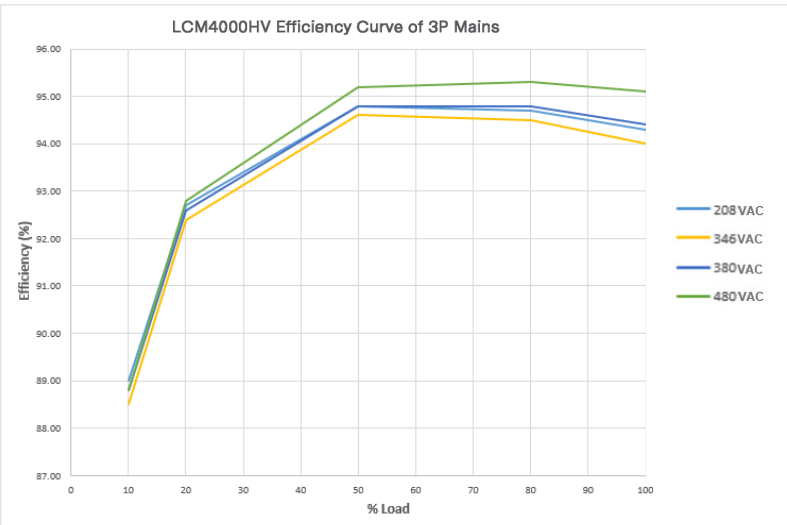

- 208 VAC (nominal)
- 380 VAC (nominal)
- 480 VAC (nominal)

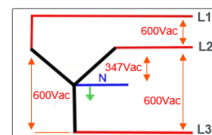

- 347 VAC (nominal)

Load %	Efficiency (%)			
	208 VAC	346 VAC	380 VAC	480 VAC
10	89.00	88.50	88.80	88.80
20	92.70	92.40	92.60	92.80
50	94.80	94.60	94.80	95.20
80	94.70	94.50	94.80	95.30
100	94.30	94.00	94.40	95.10

## ENVIRONMENTAL SPECIFICATIONS

Operating Conditions	
Operating Temperature	0 °C to 50 °C at 100% rated load, 50 °C to 60 °C derate to 3200 W
Storage Temperature	-40 °C to 85 °C
Operating Humidity	20% to 90% non condensing
Storage Humidity	10% to 95% non condensing
Operating Altitude	Up to 9,842 feet above sea level (3,000 meters)
Storage Altitude	Up to 30,000 feet above sea level (9,144 meters)
Shipping and Handling	NSTA for <100 lbs; MIL-STD-2073-1 >100 lbs
Cooling	Internal fan with variable speed control
Vibration and Shock	IEC068-2 / IEC721-3 Standard & Levels

## ORDERING INFORMATION

### LCM4000HV

Description	Model Number	Input Range	Default Output Setting <sup>1</sup>		
			Output Mode	Output Current	Output Voltage
Standalone 4 kW module	LCM4000HV-T-P	187 to 264 VAC	Current Source	0 A	250 VDC
	LCM4000HV-T-S	311 to 528 VAC	Current Source	0 A	250 VDC
Pluggable 4 kW module for shelf use	LCM4000HV-P-P	187 to 264 VAC	Current Source	0 A	250 VDC
	LCM4000HV-P-S	311 to 528 VAC	Current Source	0 A	250 VDC

Note 1 - Output voltage and current adjustment range please refer to Electrical Specifications section.

### LCM12K

Model Number	Description	Input Range
LCM12K-SHF-N	12 kW 250 V 1U SHELF	HIGH LINE, 600 VAC W/NEUTRAL
LCM12K-SHF-P	12 kW 250 V 1U SHELF	LOW LINE, 200/220/230/240 VAC
LCM12K-SHF-S	12 kW 250 V 1U SHELF	HIGH LINE, 380/480 VAC
LCM12K-BLK	1U BLANK FILLER PANEL	N/A

MECHANICAL DRAWINGS - LCM4000HV-T

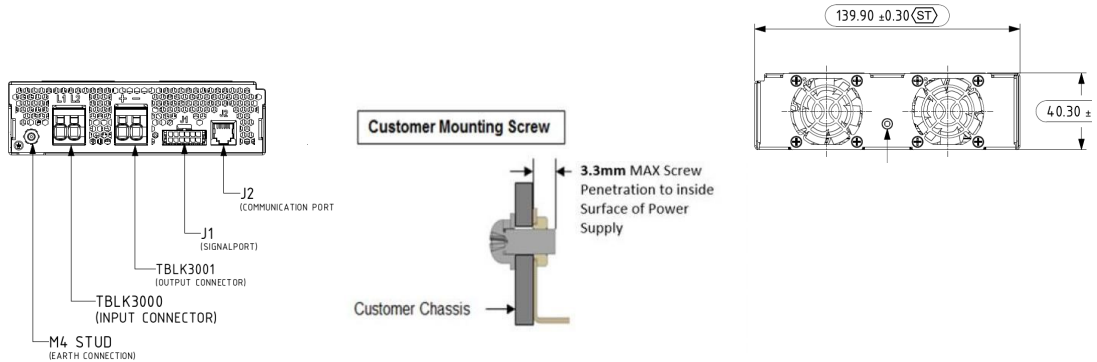
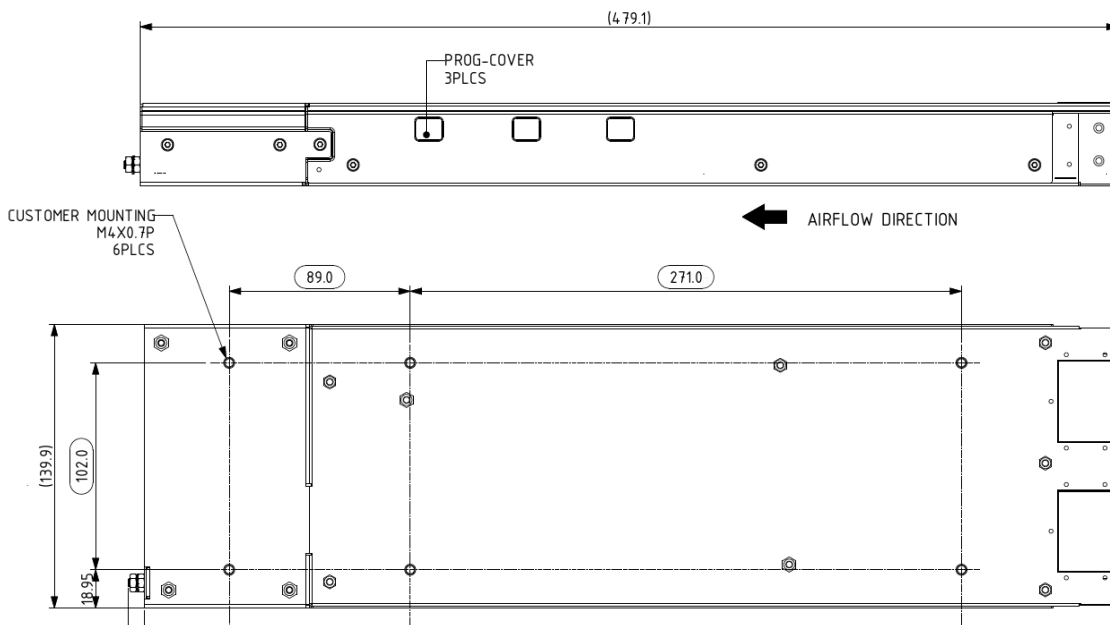
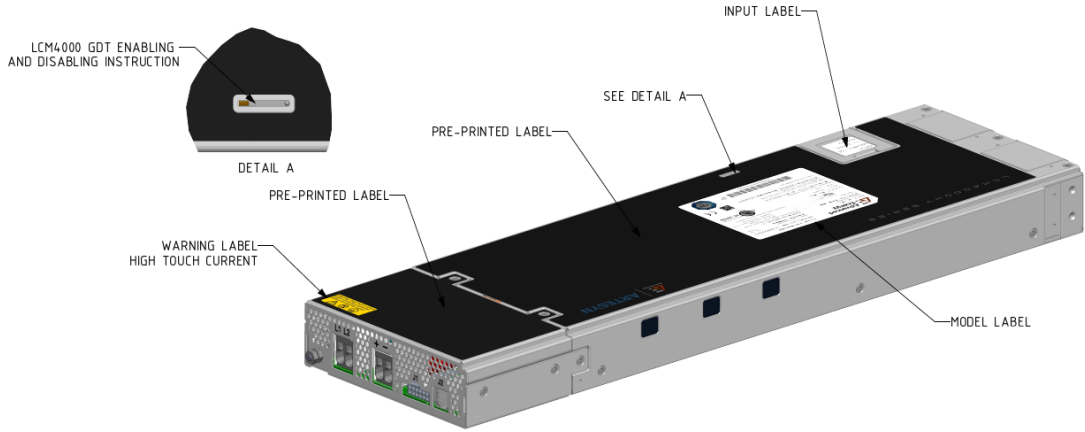



PIN ASSIGNMENT - LCM4000HV-T

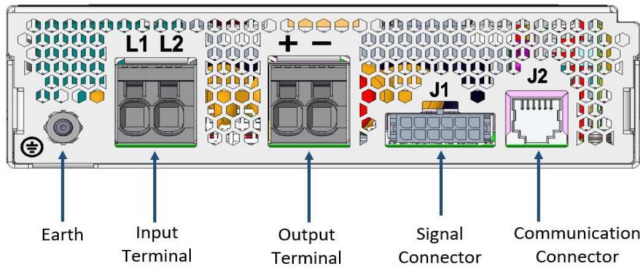

Connector Details	
Input terminal <sup>†</sup>	Euro style terminal block
Output terminal	Euro style terminal block
Signal connector	Molex micro-fit
Communication connector	RJ11

Note 1 - For single phase application, the Neutral is connected to either L1 or L2 terminal.

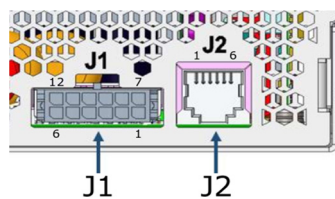

Signal and Communication Connector (J1 & J2)

J1 Pin Number	Signals	Description
1	SPARE	SPARE
2	SPARE	SPARE
3	PSU_AC_OK#	Global AC_OK
4	PSU_DC_OK#	Global DC_OK
5	PSU_ALERT#	Alert signal
6	PSU_ON#	Output remote on/off
7	ISO_RTN	Isolated signal return
8	ISO_RTN	Isolated signal return
9	5V_ISO	5V_ISO standby power
10	0-24V_PROG	0-24V programming
11	0-10V_PROG	0-10V programming
12	ISO_RTN	Isolated signal return
J2 Pin Number	Signals	Description
1	SPARE	SPARE
2	SPARE	SPARE
3	RS485 RTN	Communication lines RTN for RS485
4	SPARE	SPARE
5	RS485_A_EXT	Communication lines for RS485
6	RS485_B_EXT	Communication lines for RS485

MECHANICAL DRAWINGS - LCM4000HV-P

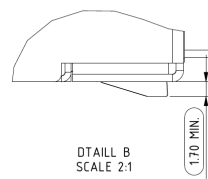
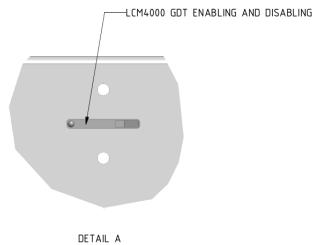
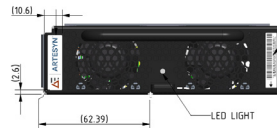
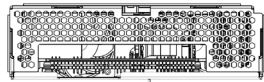
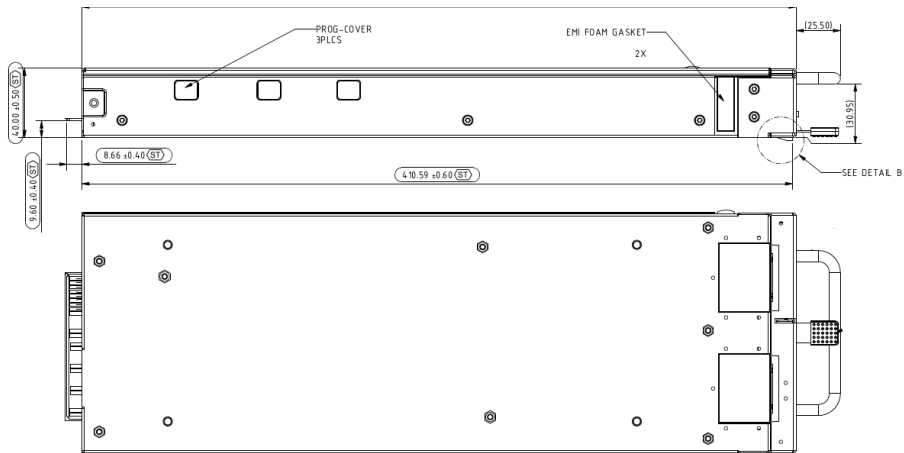
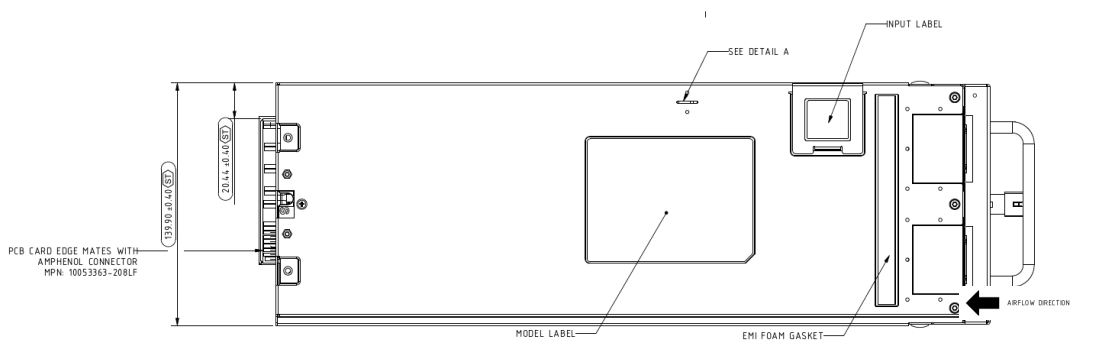
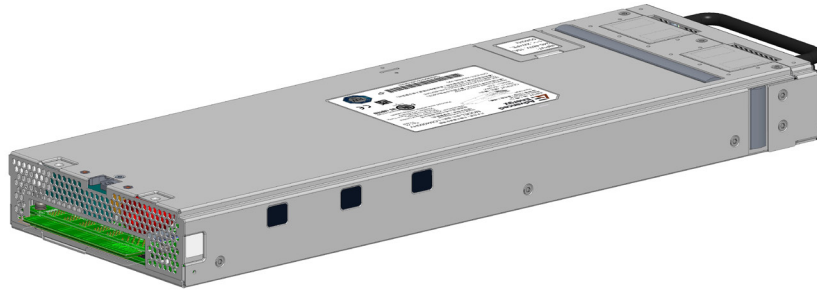

MECHANICAL DRAWINGS - LCM12K

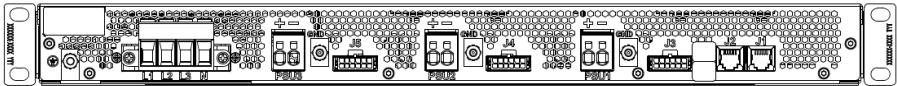
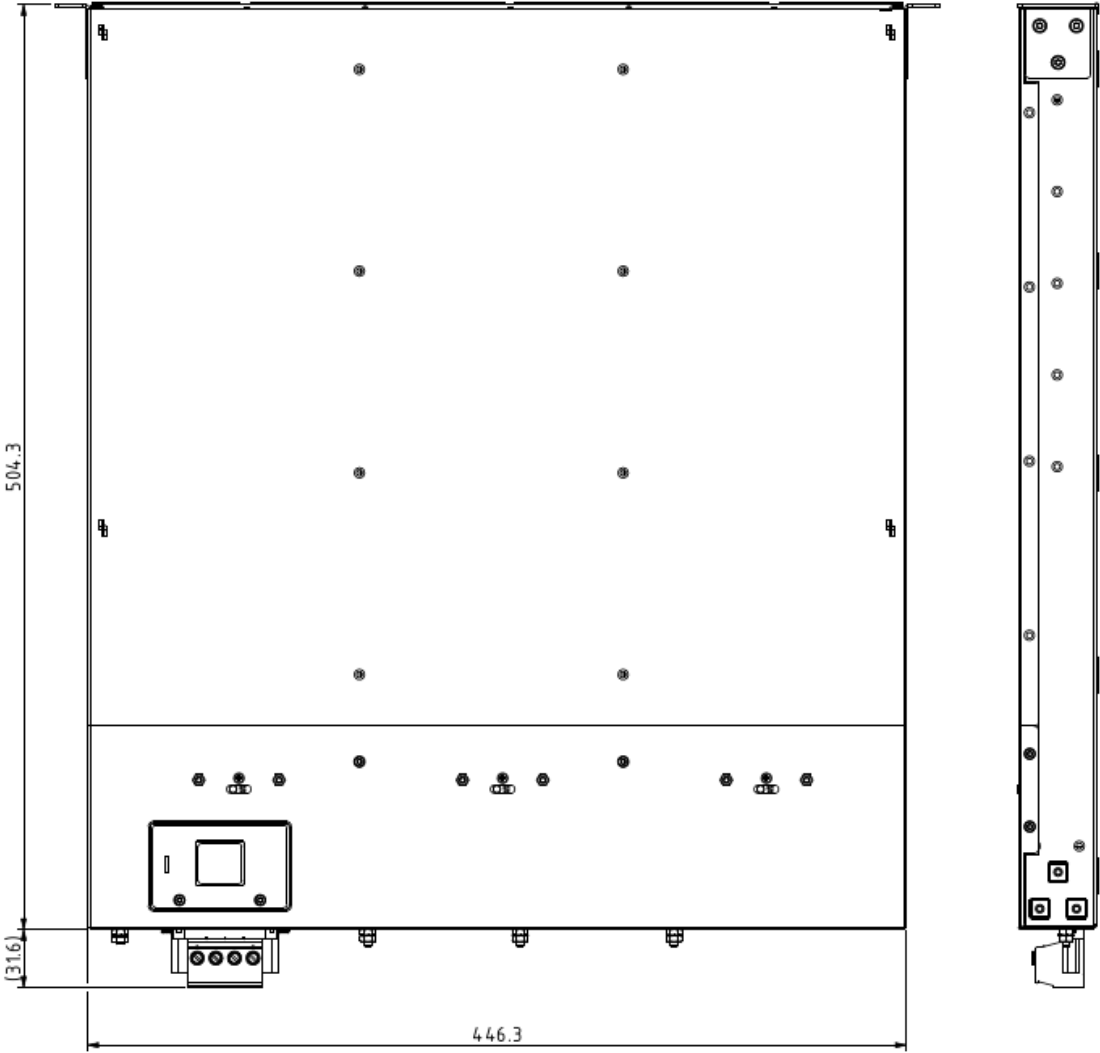
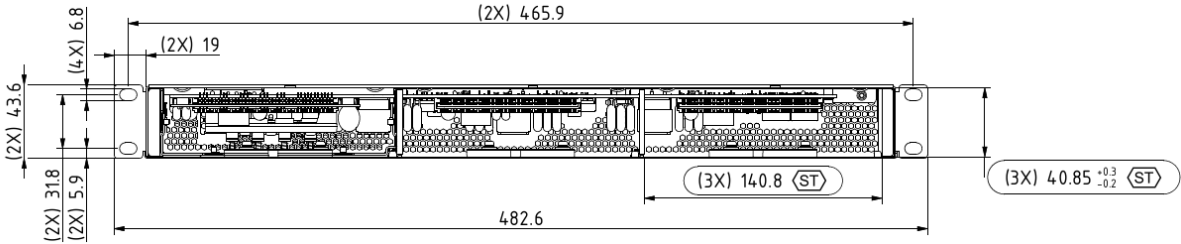

MECHANICAL DRAWINGS - LCM12K



LCM12K Shelf Front View



LCM12K Shelf Rear View

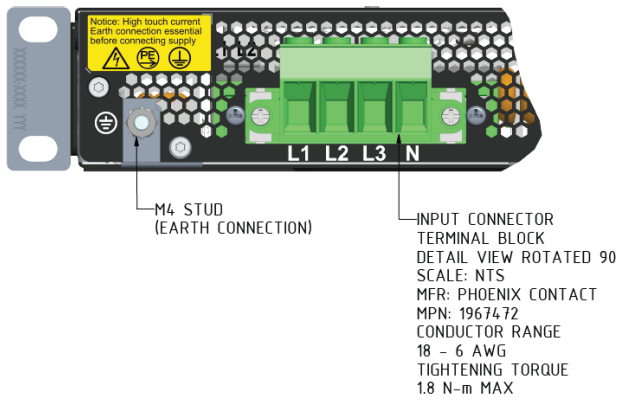

MECHANICAL DRAWINGS - LCM12K

Ear Bracket Mounting Option

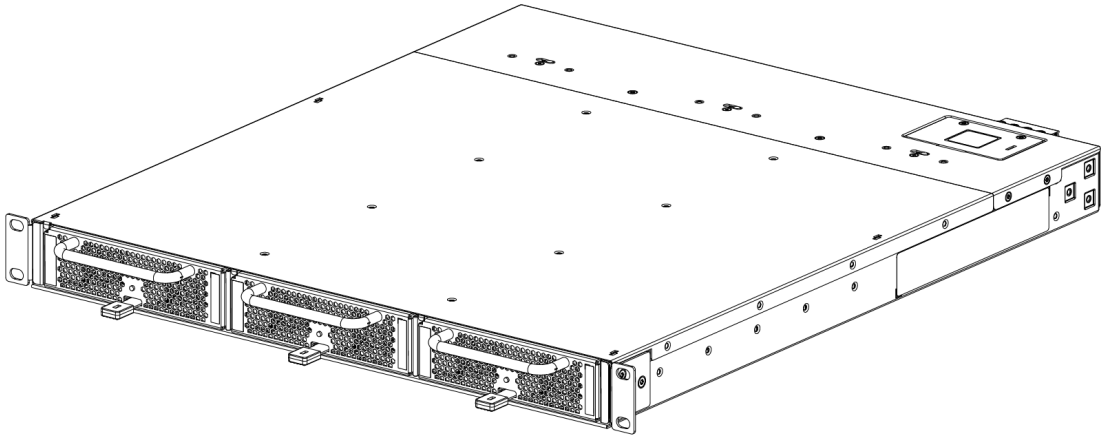

Option A - Ear bracket at front

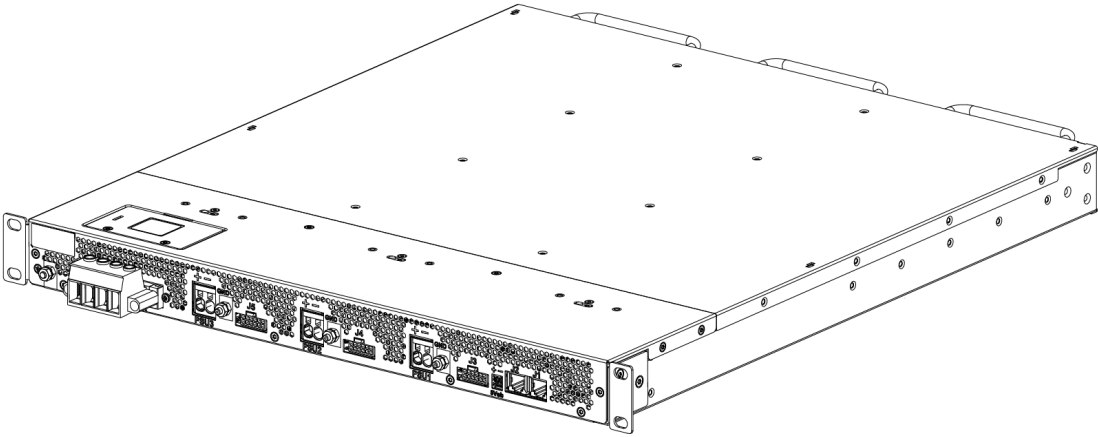

Option B - Ear bracket at rear

Mounting Screw Information	
Thread type	Metric 3.5
Head type & length	Torx flat head, 8 mm
Torque	12-14 kgf-cm

**PIN ASSIGNMENT - LCM12K**

**Output/Singal/Communication Connectors**

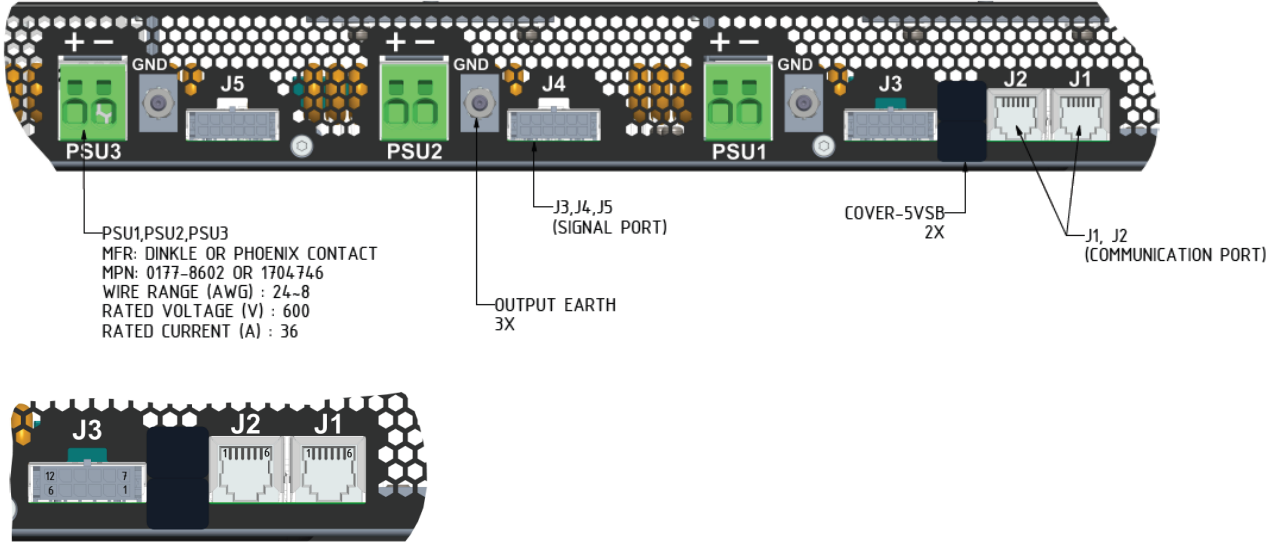

J1/J2 Pin Number	Signals	Description
1	SPARE	SPARE
2	SPARE	SPARE
3	RTN_RS485	Communication lines RTN for RS485
4	SPARE	SPARE
5	RS485_A_EXT	Communication lines for RS485
6	RS485_B_EXT	Communication lines for RS485

Pin Number	J3	J4	J5
1	PS_ON#1	PS_ON#2	PS_ON#3
2	PSU_PRESENT#1	PSU_PRESENT#2	PSU_PRESENT#3
3	ALERT#1	ALERT#2	ALERT#3
4	AC_OK#1	AC_OK#2	AC_OK#3
5	DC_OK#1	DC_OK#2	DC_OK#3
6	0-10V_PROG1_1	0-10V_PROG1_2	0-10V_PROG1_3
7	ISO_PRTN	ISO_PRTN	ISO_PRTN
8	0-24V_PROG1_1	0-24V_PROG1_2	0-24V_PROG1_3
9	ISO_PRTN	ISO_PRTN	ISO_PRTN
10	SPARE	SPARE	SPARE
11	SPARE	SPARE	SPARE
12	SPARE	SPARE	SPARE

## MISCELLANEOUS SPECIFICATIONS

### MTBF

The power supply has a minimum MTBF of 200K hours using the Telcordia specifications @ 25 °C ambient at full load, nominal line of 220V/240 VAC. With the power supply installed in a system in a 35 °C ambient environment and operating at full load, capacitor life will be 5 years minimum for ALL electrolytic capacitors contained within this power supply. The power supply will demonstrate an MTBF level of > 500,000 hours based on actual field population operational hours.

### QUALITY ASSURANCE

Full QAV testing is conducted in accordance with Advanced Energy’s Artesyn Standards with reports available upon request.

### WARRANTY

Advanced Energy’s Artesyn Embedded Power warrant the power supply to be free of defects in materials and workmanship for a minimum period of five (5) years from the date of shipment, when operated within specifications. The warranty is fully transferable to the end owner of the equipment powered by the supply.

### WEIGHT

Model	Weight	
LCM12K-SHF	4728 grams	10.40 lbs.
LCM4000HV-P	2992 grams	6.58 lbs.
LCM4000HV-T	3316 grams	7.30 lbs.



For international contact information,  
visit [advancedenergy.com](http://advancedenergy.com).

[powersales@aei.com](mailto:powersales@aei.com) (Sales Support)  
[productsupport.ep@aei.com](mailto:productsupport.ep@aei.com) (Technical Support)  
+1 888 412 7832

## ABOUT ADVANCED ENERGY

Advanced Energy (AE) has devoted more than three decades to perfecting power for its global customers. AE designs and manufactures highly engineered, precision power conversion, measurement and control solutions for mission-critical applications and processes.

Our products enable customer innovation in complex applications for a wide range of industries including semiconductor equipment, industrial, manufacturing, telecommunications, data center computing, and medical. With deep applications know-how and responsive service and support across the globe, we build collaborative partnerships to meet rapid technological developments, propel growth for our customers, and innovate the future of power.

PRECISION | POWER | PERFORMANCE

---

Specifications are subject to change without notice. Not responsible for errors or omissions. ©2022 Advanced Energy Industries, Inc. All rights reserved. Advanced Energy®, AE® and Artesyn™ are U.S. trademarks of Advanced Energy Industries, Inc.



## X-ON Electronics

Largest Supplier of Electrical and Electronic Components

*Click to view similar products for [Rack Mount Power Supplies](#) category:*

*Click to view products by [Artesyn Embedded Technologies](#) manufacturer:*

Other Similar products are found below :

[G08-M02](#) [HFE2500BP](#) [HWS100A-24/ADIN](#) [HWS50A-24/ADIN](#) [73-495-0233](#) [750-1016](#) [YTM.00046.0](#) [HFE1600-KIT](#) [CC109146503](#)  
[DHP-1UT-B](#) [G60-45-3P480](#) [LCM12K-SHF-S](#) [92100139A](#) [RKP-1UI](#) [LCM600W-T-4-A](#) [FNP600-12G](#) [73-954-0001C](#) [LCM600Q-T-4-A](#)  
[RCP100-GRY](#) [LCM600Q-N](#) [DRP-3200-48](#) [RCP-2000-24](#) [RCP-1600-24](#) [LCM600U-T-A](#) [N5766A/861](#) [LCM1000Q-T](#) [RFE160012/S](#)  
[LCM600Q-A](#) [FPST1U/P](#) [LCM300W-T](#) [LCM600L-A](#) [J85480S1L21Z](#) [HFE2500LAN](#) [UFR6000PJ](#) [HFE1600-D1U](#) [GEN30-50](#)  
[TET3000-12-069RA](#) [N6700C/903](#) [TSR10](#) [TET2000-12-086NA](#) [PET2000-12-074RA](#) [RCP-MU](#) [RCP-3K1UI-12](#) [N5745A/903](#) [N5764A/861](#)  
[N5767A/861](#) [605-10144-2AC](#) [N5748A/903](#) [N5744A/903](#) [N5751A/903](#)