

POWER

LCM300

310 Watt Bulk Front End

Data Sheet

Total Power: 310 W
of Outputs: Single
Outputs: 12 to 60 V
 Optional 5.0 V standby

SPECIAL FEATURES

- 310 W output power (350 W at 45 °C for 24 V and 36 V models)
- Low Cost
- 1.61" x 4.0" x 7.0"
- 7.1 Watts Per Cubic Inch
- Industrial/Medical Safety
- 40 °C to 70 °C with derating
- Optional 5 V @ 2 A Housekeeping
- High Efficiency: 91% @ 230 Vac
- Variable speed "Smart Fans"
- DSP controlled
- PMBus Compliant
- Conformal coat option
- ±20% adjustment range
- Margin programming
- OR-ing FET

COMPLIANCE

- EMI Class B
- EN61000 Immunity
- RoHS 2
- PMBUS

SAFETY

- UL 60950-1
508/1598/1433
60601-1 Ed 3
- CSA 60950-1
- VDE 60950-1
60601
- China CCC
- CB Scheme Report/Cert



Electrical Specifications

| Input | |
|-----------------------|--|
| Input range: | 90 - 264 Vac (Operating) 115/230 Vac (Nominal) TERMINAL BLOCK |
| Frequency: | 47 - 63 Hz, Nominal 50/60 |
| Input fusing: | Internal 8 A fuses, both lines fused |
| Inrush current: | < 20 A peak, cold start at 25 °C |
| Power factor: | 0.98 typical, meets EN61000-3-2 |
| Harmonics: | Meets IEC 1000-3-2 requirements |
| Input current: | 5 Arms max input current, at 90 Vac |
| Hold up time: | 20 ms minimum for Main O/P, at full rated load |
| Efficiency: | > 91% typical at full Load / 230 Vac nominal |
| Leakage current: | < 0.3 mA at 264 Vac |
| ON/OFF power switch: | N/A |
| Power line transient: | MOV directly after the fuse |
| Isolation: | Isolation: PRI-Chassis 2500 Vdc Basic PRI-SEC 4000 Vac Reinforced 2xMOPP SEC-Chassis 500 Vdc |

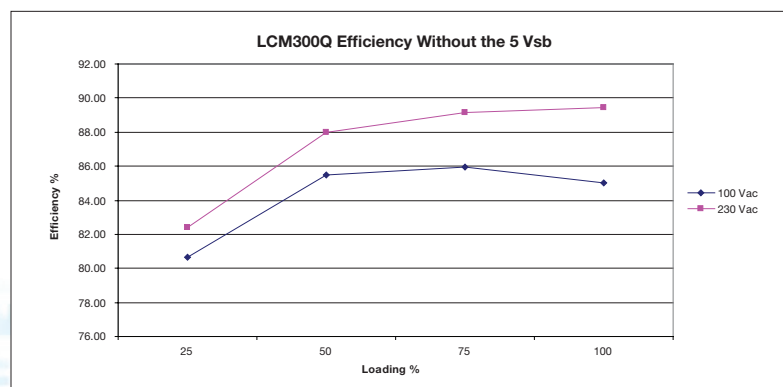

Electrical Specifications

| Output | | |
|-------------------------------|--|---|
| Output rating: | See table 1 | 90 - 264 Vac |
| Set point: | ±0.5% | 90 - 264 Vac |
| Total regulation range: | Main output ±2% 5 Vsb ±1% | Combined line/load/transient when measured at output terminal |
| Rated load: | 310 W (360 W for current Q and U variants) | Derate linear to 50% from 50 °C to 70 °C |
| Minimum load: | Main output @ 0.0 A 5 Vsb @ 0.0 A | No loss of regulation |
| Output noise (PARD): | 1% max p-p 100 mV max p-p | Main output 5 Vsb output Measured with a 0.1 µF Ceramic and 10 µF Tantalum Capacitor on any output, 20 MHz |
| Output voltage overshoot: | | No overshoot/undershoot outside the regulation band during on or off cycle |
| Transient response: | < 300 µSec | 50% load step @ 1 A/µs Step load valid between 10% to 100% of output rating Recovery time to within 1% of set point at onset of transient |
| Max units in parallel: | | Up to 10 |
| Short circuit protection: | Protected, no damage to occur | Bounce mode |
| Remote sense: | | Compensation up to 500 mV |
| Output isolation: | | Standard per safety requirements |
| Forced load sharing: | To within 10% of all shared outputs | Analog sharing control |
| Overload protection (OCP): | 105% to 125% 120% to 170% | Main output 5 Vsb output |
| Overvoltage protection (OVP): | 125% to 145% 110% to 125% | 12 V output 5 Vsb output |

Environmental Specifications

| | |
|-------------------------------|---|
| Operating temperature: | -40 °C to +70 °C, linear derating to 50% from 50 °C to 70 °C |
| Storage temperature: | -40 °C to +85 °C |
| Humidity: | 20 to 90%, non-condensing. Operating. Conformal coat option available |
| Fan noise: | < 45 dBA, 80% load at 40 °C; Fan Off when unit is inhibited |
| Altitude: | Operating - 16,405 feet (5000m) Storage - 30,000 feet |
| Shock: | MIL-STD-810F 516.5, Procedure I, VI. Storage |
| Vibration: | MIL-STD-810F 514.5, Cat. 4, 10. Storage |

Ordering Information

| Model Number* | Output | Nominal Output Voltage Set Point | Set Point Tolerance | Adjustment Range | Current | | Output Ripple P/P (0-50 °C) | Max Continuous Power | Combined Line/ Load Regulation |
|---------------|--------|----------------------------------|---------------------|------------------|---------|---------|-----------------------------|----------------------|--------------------------------|
| | | | | | Min | Max | | | |
| LCM300L | 12 V | 12 V | ±0.5% | 9.6 - 14.4 V | 0 A | 25.0 A | 120 mV | 310 W | 2% |
| LCM300N | 15 V | 15 V | ±0.5% | 12.0 - 18.0 V | 0 A | 20.0 A | 150 mV | 310 W | 2% |
| LCM300Q | 24 V | 24 V | ±0.5% | 19.2 - 28.8 V | 0 A | 12.5 A* | 240 mV | 310 W | 2% |
| LCM300U | 36 V | 28 V | ±0.5% | 28.8 - 43.2 V | 0 A | 8.4 A* | 360 mV | 310 W | 2% |
| LCM300W | 48 V | 36 V | ±0.5% | 38.4 - 57.6 V | 0 A | 6.3 A | 480 mV | 310 W | 2% |

* 14.5 A rating on LCM300Q-T and 9.7 A on LCM300U-T when max temp does not exceed 45C (Total Power = 350 W)

Pin Assignment

| Signals | Name Description | Pin Number(s) |
|----------|---|----------------|
| +Vout | Power rail | SK4 |
| GND | Power GND | SK5 |
| Signals | Name Description | SK2 Pin Number |
| A2 | EEPROM Address | 1 |
| -VPROG | Return connection of external supply for Margin Programming | 2 |
| A1 | EEPROM Address | 3 |
| -Vsense | Remote Sense Return | 4 |
| ISHARE | Load share voltage | 5 |
| A0 | EEPROM Address | 6 |
| SDA1 | Serial Data Signal (I ² C) | 7 |
| +VPROG | Positive connection of external supply for Margin Programming | 8 |
| SCL1 | Serial Clock Signal (I ² C) | 9 |
| +Vsense | Remote Sense Positive | 10 |
| 5VSB | 5 V standby | 11 |
| GND | 5 V standby Return | 12 |
| 5VSB | 5 V standby | 13 |
| G_DCOK_C | Global DCOK Collector | 14 |
| GPIOA6 | EEPROM Write Protect | 15 |
| G_DCOK_E | Global DCOK Emitter (GND) | 16 |
| GND | Return Ground for output signal and I2C communication | 17 |
| G_ACOK_C | Global ACOK Collector | 18 |
| INH_EN | Turn Off Main Output | 19 |
| G_ACOK_E | Global ACOK Emitter (GND) | 20 |

Note: Mating connector for SK2 is LANDWIN CI0120P1HD0-LF

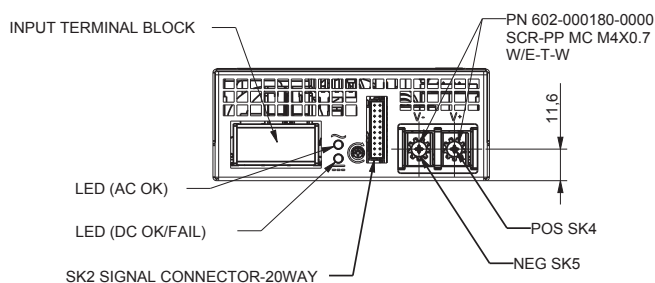

PSU Front View

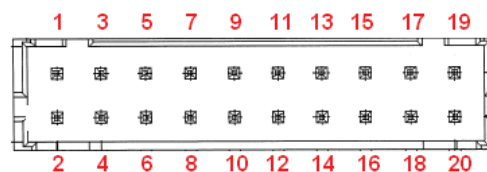

Signal Output Signal Connectors (SK2)

SK2 Mating Connector: JST Part Number PHDR-20VS;
Contact Pins: JST Part Number SPHD-001T-P0.5

LED INDICATORS

2 provided are clearly visible up to a 45 degree offset from vertical with office environment ambient lighting. The status is reflected in the indicator color.

The DC_OK LED LED shall light green if the DC output is within specification, and should be off if the output falls out of specification.

The AC_OK LED LED is green if the AC is within specification and off when out of specification. Note: With 5 V standby, Green also indicates that PSU is in standby mode/output off.

CONTROL SIGNALS

AC_OK Open collector 0.5 V maximum at 10 mA. Both emitter and collector access provided.

DC_OK Open collector 0.5 V maximum at 10 mA. Both emitter and collector access provided.

PS_INHIBIT/ENABLE Signal 0.0 - 0.5 V contact closure, output OFF (output ON for LCM300U-T-4-401)

Ordering Information Table 2

| LCMXXXXY | | - | A | - | B | - | C | - | ### |
|----------------------------------|----|---|--------------------|---|------------------|---|--------------------|---|---|
| Case Size | | | Input Termination | | Acoustic Noise | | Option Codes | | Hardware Code |
| 1-Phase input where XXXX = | | | | | | | | | |
| 300 = 1.61" x 4.0" x 7.0", 300 W | | | | | Blank = Standard | | Blank = No Options | | Factory Assigned for Modified standards |
| Voltage Code Y = | | | T = Terminal Block | | | | 1 = Conformal Coat | | |
| Code | | | | | | | 4 = 5 V Standby | | |
| Code | | | | | | | 5 = Opt 1 + 4 | | |
| L | 12 | | | | | | | | |
| N | 15 | | | | | | | | |
| Q | 24 | | | | | | | | |
| U | 36 | | | | | | | | |
| W | 48 | | | | | | | | |

Mechanical Drawings

NOTES:

- PARTS MUST BE COMPLETELY ASSEMBLED.
- FOR LABEL PRINTING DETAILS, REFER TO IPS.
- QUALITY CONTROLLED DIMENSIONS. THESE DIMENSIONS TO BE INCLUDED IN THE MECHANICAL CPK OF 1.33
- CASING PARTS USED MUST HAVE MATCHING COLOR. IN ORDER TO ENSURE COLOR MATCHING OF PARTS, IT IS REQUIRED THAT THE RAW MATERIAL THAT WILL BE PROCESSED BY THE FABRICATOR WILL COME FROM THE SAME SUPPLIER AND THE SHEETMETAL FABRICATOR FOR ALL MATCHING PARTS MUST BE THE SAME. TO AVOID COLOR VARIATIONS ON THE SAME LOT DELIVERED, ALL PARTS WITH MATCHING COLOR REQUIREMENT SHOULD BE DELIVERED AS A SET BY THE FABRICATOR.
- SHEARED EDGES VISIBLE TO THE CUSTOMER SHOULD HAVE NO RUST FORMATION. IF RUST FORMATION IS PRESENT THEN A CONCEALING LAYER OF SILVER INK OR SOME OTHER SUBSTITUTE SHOULD BE APPLIED ON THE RUSTED AREA.
- MOUNTING LOCATIONS SCREW PENETRATION MEASURED FROM PSU OUTER SURFACE (SEE DETAIL A)
 LOCATION A: 6mm MAX
 LOCATION B: 5mm MAX
 LOCATION C: 10mm MAX
 LOCATION D : 3mm MAX

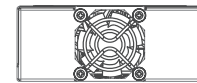
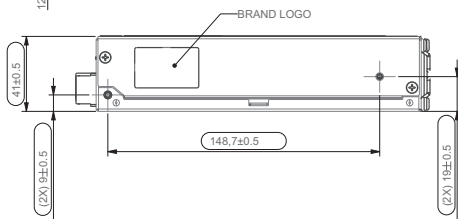
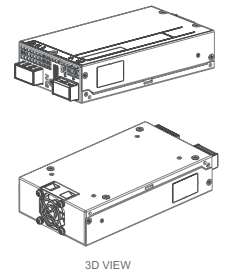
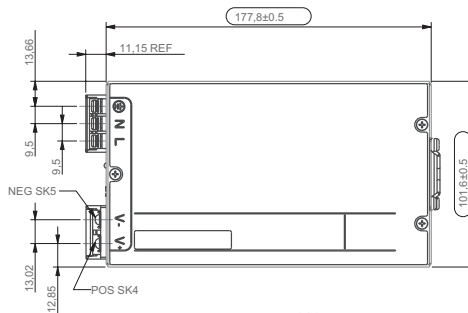
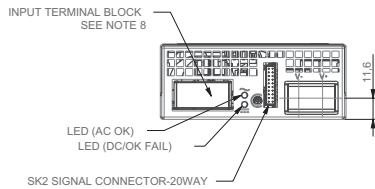

- RECOMMENDED SCREW TORQUE:
M4x0.7P = 8-10 kgf-cm
- INPUT: TERMINAL BLOCK TYPE. M3.5 SCREW TORQUE VALUE OF 12kgf-cm USING WIRE GAUGE 22-19 (9.5mm CENTERS)
- SUITABLE MATING CONNECTORS:
 9.1 FOR SK2:
 764-002569-0000 MAT-KIT LCM600 HSG-20WAY (LANDWIN)
 451-004792-0000 HSG-DR 20CKT (LWE PN: 2050S2000)
 451-000709-0000 CRIMP TERM (LWE PN: 2053T021V)
 OR
 81066010530 MAT-KIT LCM600 HSG-20WAY (CIVILUX)
 13866009350 HSG-20WAY (CX PN: C10120SD000)
 40566000920 TERM-# 22-28 (CX PN: C101TD21PE0)
- FOR INPUT TERMINAL BLOCK
 MOLEX AA-135-06 (019141-0020) or EQUIVALENT
- FOR SK4 & SK5
 MOLEX BB-124-08 (19141-0058) OR EQUIVALENT:

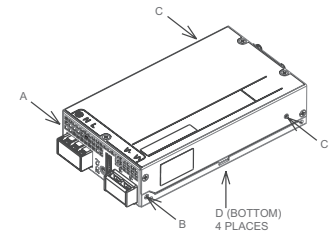
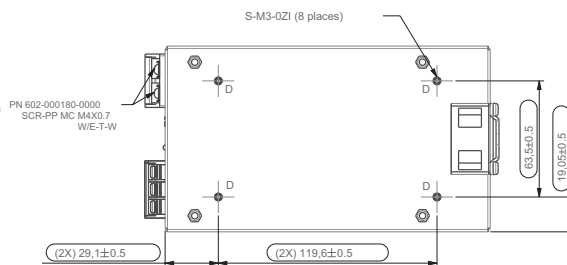

DETAIL A : MOUNTING LOCATIONS

Accessories

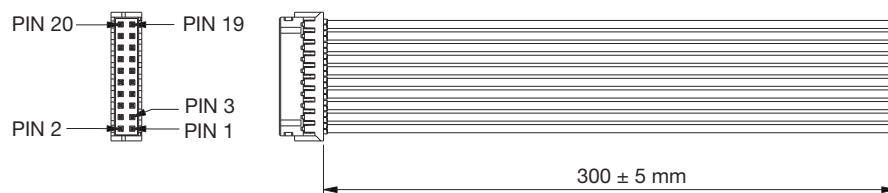

Order kit part number 73-788-001 for control connector interface with .3m wires attached

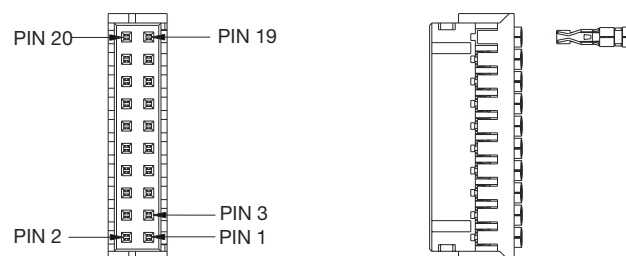

Order kit part number 73-788-002 for control connector interface with unloaded housing and 20 pins

Miscellaneous Specifications

BURN-IN

100% Burn-in at 45 °C, at 80 - 90 % load. Duration of burn-in determined by Quality Assurance Procedures.

MTBF

The power supply has a minimum MTBF of 300K hours using the Bell core 332, issue 6 specification @ 25 °C and 40 °C, ambient, at full load. With the power supply installed in a system in a 25 °C ambient environment and operating at full load, capacitor life shall be 5 years at 50 °C, minimum for ALL electrolytic capacitors contained within this power supply. The power supply shall demonstrate a MTBF level of > 500,000 hours.

QUALITY ASSURANCE

Full QAV testing shall be conducted in accordance with Artesyn Embedded Technologies Standards with reports available upon request.

WARRANTY

Artesyn Embedded Technologies shall warrant the power supply to be free of defects in materials and workmanship for a minimum period of three years from the date of shipment, when operated within specifications. The warranty shall be fully transferable to the end owner of the equipment powered by the supply.

WORLDWIDE OFFICES

Americas

2900 S.Diablo Way
Tempe, AZ 85282
USA
+1 888 412 7832

Europe (UK)

Waterfront Business Park
Merry Hill, Dudley
West Midlands, DY5 1LX
United Kingdom
+44 (0) 1384 842 211

Asia (HK)

14/F, Lu Plaza
2 Wing Yip Street
Kwun Tong, Kowloon
Hong Kong
+852 2176 3333

ARTESYN[™]
EMBEDDED TECHNOLOGIES

www.artesyn.com

While every precaution has been taken to ensure accuracy and completeness in this literature, Artesyn Embedded Technologies assumes no responsibility, and disclaims all liability for damages resulting from use of this information or for any errors or omissions. Artesyn Embedded Technologies, Artesyn and the Artesyn Embedded Technologies logo are trademarks and service marks of Artesyn Embedded Technologies, Inc. All other names and logos referred to are trade names, trademarks, or registered trademarks of their respective owners. © 2014 Artesyn Embedded Technologies, Inc.

For more information: www.artesyn.com/power
For support: productsupport.ep@artesyn.com

X-ON Electronics

Largest Supplier of Electrical and Electronic Components

Click to view similar products for [Rack Mount Power Supplies](#) category:

Click to view products by [Artesyn Embedded Technologies](#) manufacturer:

Other Similar products are found below :

[HFE2500BP](#) [PET1300-12-054NAE](#) [HFE1600BP](#) [73-311-0001](#) [73-317-0148](#) [73-495-0233](#) [750-1016](#) [SFP450-S101G](#) [FUP550SNRPS](#)
[VRA.00335.0](#) [VRA.00334.0](#) [VRA.00333.0](#) [HFE1600-KIT](#) [CC109146503](#) [RKP-1UI](#) [PFE1100-12-054ND](#) [FND300-1012G](#) [73-951-0001T](#)
[73-954-0001C](#) [DS550DC-3](#) [DRP-3200-48](#) [RCP-2000-24](#) [TSR10](#) [TET2000-12-086NA](#) [PET2000-12-074RA](#) [RCP-MU](#) [605-10144-2AC](#)
[6609006-5](#) [D1U54P-W-1200-12-HC4PC](#) [DS450DC-3](#) [DS650DC-3](#) [HPR12K-00-001](#) [LCM1500L-T-4](#) [LCM300Q-T](#) [LCM300W-T-4](#)
[LCM600N-T-4-A](#) [FNP600-48G](#) [FNR-3-48G](#) [FNR-5-12G](#) [PFS1200-12-054RAH](#) [PFS1200-12-054RD](#) [SPSPFE3-05G](#) [TET3200-12-069RA](#)
[IEC-A-1](#) [FXX1600PCRPS](#) [915606](#) [DHP-1UT-A](#) [DRP-3200-24](#) [RCP-1000-12](#) [RCP-1000-12-C](#) [RCP-1000-24](#)