

PTH12050 12 Vin

Total Power: 33 Watts
of Outputs: Single

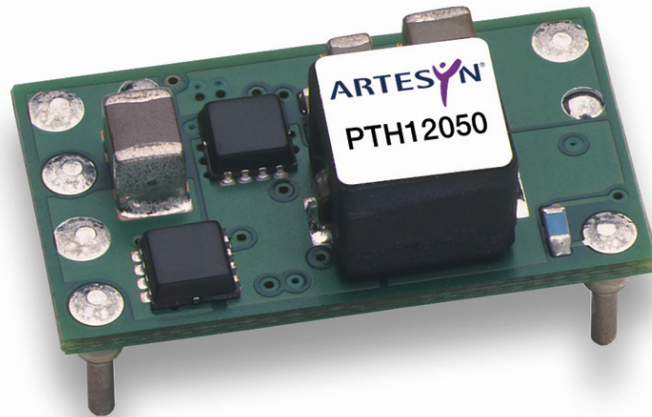

Special Features

- 6 A output current
- 12 V input voltage
- Wide-output voltage adjust
1.2 Vdc - 5.5 Vdc for suffix 'W' &
0.8 Vdc - 1.8 Vdc for suffix 'L'
- Auto-track™ sequencing*
- Pre-bias start-up
- Efficiencies up to 93%
- Output ON/OFF inhibit
- Output voltage sense
- Point-of-Load-Alliance (POLA)
compatible
- Available RoHS compliant
- 2 Year Warranty

Safety

- UL/cUL CAN/CSA-C22.2
No. 60950-1-03/UL 60950-1,
File No. E174104
- TÜV Product Service
(EN60950) Certificate No.
B 04 06 38572 044
- CB Report and Certificate to
IEC60950, Certificate No.
US/8292/UL

Specifications

Input		
Input voltage range:	(See Note 3, page 3)	10.8 - 13.2 Vdc
Input current:	No load	10 mA typ.
Remote ON/OFF:	(See Note 1, page 3)	Positive logic
Start-up time:		1 V/ms
Undervoltage lockout:		8.8 - 0.4 V typ.
Track input voltage:	Pin 8 (See Note 6, page 3)	± 0.3 Vin

All specifications are typical at nominal input, full load at 25 °C unless otherwise stated. $C_{in} = 100 \mu\text{F}$,
 $C_{out} = 0 \mu\text{F}$

*Auto-track™ is a trade mark of
Texas Instruments



Specifications Continued

Output		
Voltage adjustability: (See Note 4, page 3)	Suffix 'W' Suffix 'L'	1.2 - 5.5 Vdc 0.8 - 1.8 Vdc
Setpoint accuracy:		± 2.0% Vo
Line regulation:		± 5 mV typ.
Load regulation:		± 5 mV typ.
Total regulation:		± 3.0% Vo
Minimum load:		0 A
Ripple and noise: 20 MHz bandwidth	Suffix 'W' V _o 2.5 V V _o > 2.5 V Suffix 'L' V _o 1.0 V V _o > 1.0 V	25 mV pk-pk 1% V _o 20 mV pk-pk 30 mV pk-pk
Temperature co-efficient:	-40 °C to +85 °C	± 0.5% Vo
Transient response:	(See Note 5, page 3)	70 μs recovery time Overshoot/undershoot 100 mV
Margin adjustment:		± 5.0% Vo

EMC Characteristics		
Electrostatic discharge:	EN61000-4-2, IEC801-2	
Conducted immunity:	EN61000-4-6	
Radiated immunity:	EN61000-4-3	
General Specifications		
Efficiency:	See tables on page 3	
Insulation voltage:	Non-isolated	
Switching frequency: Over V _{in} and I _o ranges	Suffix 'W' Suffix 'L'	320 kHz typ. 250 kHz typ.
Approvals and standards:	EN60950 UL/cUL60950	
Material flammability:	UL94V-0	
Dimensions:	(L x W x H)	22.10 x 12.57 x 8.50 mm 0.870 x 0.495 x 0.335 in
Weight:	2.9 g (0.10 oz)	
MTBF:	Telcordia SR-332	7,092,000 hours
Environmental Specifications		
Thermal Performance: (See Note 2, page 3)	Operating ambient, temperature Non-operating	-40 °C to +85 °C -40 °C to +125 °C
MSL ('Z' suffix only):	JEDEC J-STD-020C	Level 3
Protection		
Short-circuit:	Auto reset	14 A typ.

Ordering Information

Output Power (max)	Input Voltage	Output Voltage	Output Currents		Efficiency (max)	Regulation		Model Numbers ^(9, 10)
			Min	Max		Line	Load	
33 W	10.8 - 13.2 Vdc	0.8 - 1.8 Vdc	0 A	6 A	88%	±5 mV	±5 mV	PTH12050L
33 W	10.8 - 13.2 Vdc	1.2 - 5.5 Vdc	0 A	6 A	93%	±5 mV	±5 mV	PTH12050W

Part Number System with Options

PTH12050WAST

Product Family
Point of Load Alliance
Compatible

Input Voltage
12 = 12 V

Output Current
05 = 6 A

Mechanical Package
Always 0

Packaging Options
No Suffix = Trays
T = Tape and Reel⁽⁷⁾

Mounting Option⁽⁸⁾

D = Horizontal Through-Hole (RoHS 6/6)
H = Horizontal Through-Hole (RoHS 5/6)
S = Surface-Mount Solder Ball (RoHS 5/6)
Z = Surface-Mount Solder Ball (RoHS 6/6)

Pin Option

A = Through-Hole Std. Pin Length (0.140")
A = Surface-Mount Tin/Lead Solder Ball

Output Voltage Code

W = Wide
L = Low Voltage

Output Voltage Adjustment of the PTH12050 Series

The ultra-wide output voltage trim range offers major advantages to users who select the PTH12050. It is no longer necessary to purchase a variety of modules in order to cover different output voltages. The output voltage can be trimmed in a range of 1.2 Vdc to 5.5 Vdc for suffix 'W' and 0.8 Vdc to 1.8 Vdc for suffix 'L'. When the PTH12050 converter leaves the factory the output has been adjusted to the default voltage of 1.2 V for the PTH12050W and 0.8 V for the PTH12050L.

Notes

- Remote ON/OFF. Positive Logic
ON: Pin 3 open; or $V > V_{in} - 0.5 V$
OFF: Pin 3 GND; or $V < 0.8 V$ (min - 0.2 V).
- See Figure 1 for safe operating curve.
- A 100 μF electrolytic input capacitor is required for proper operation. The capacitor must be rated for a minimum of 750 mA rms of ripple current. C2 = 10 μF ceramic capacitor, required for output voltages of 3.3 V and higher
- An external output capacitor is not required for basic operation. Adding 100 μF of distributed capacitance at the load will improve the transient response.
- 1 A/ μs load step, 50 to 100% $I_{o,max}$, $C_{out} = 100 \mu F$.
- If utilized V_{out} will track applied voltage by $\pm 0.3 V$ (up to V_o set point).
- Tape and reel packaging only available on the surface-mount versions.
- The pk-pk output ripple voltage is measured with an external 10 μF ceramic capacitor. See Figure 3 for Standard application schematic.
- To order Pb-free (RoHS compatible) surface-mount parts replace the mounting option 'S' with 'Z', e.g. PTH12050WAZ. To order Pb-free (RoHS compatible) through-hole parts replace the mounting option 'H' with 'D', e.g. PTH12050WAD.
- NOTICE: Some models do not support all options. Please contact your local Emerson Network Power representative or use the on-line model number search tool at <http://www.PowerConversion.com> to find a suitable alternative.

Efficiency Table - PTH12050W ($I_O = 5 A$)

Output Voltage	Efficiency
$V_o = 5.0 V$	93%
$V_o = 3.3 V$	91%
$V_o = 2.5 V$	89%
$V_o = 2.0 V$	88%
$V_o = 1.8 V$	87%
$V_o = 1.5 V$	86%
$V_o = 1.2 V$	84%

Efficiency Table - PTH12050L ($I_O = 5 A$)

Output Voltage	Efficiency
$V_o = 1.8 V$	88%
$V_o = 1.5 V$	87%
$V_o = 1.2 V$	85%
$V_o = 1.0 V$	83%
$V_o = 0.8 V$	81%

Characteristic Data

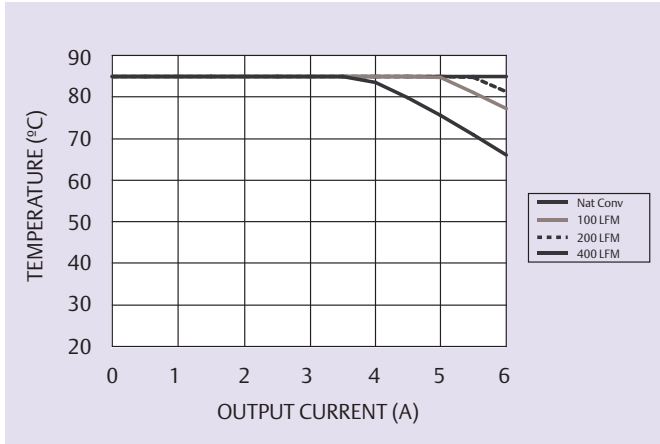

Figure 1 - Safe Operating Area for PTH12050W
Vin = 12 V, Output Voltage = 3.3 V (See Note A)

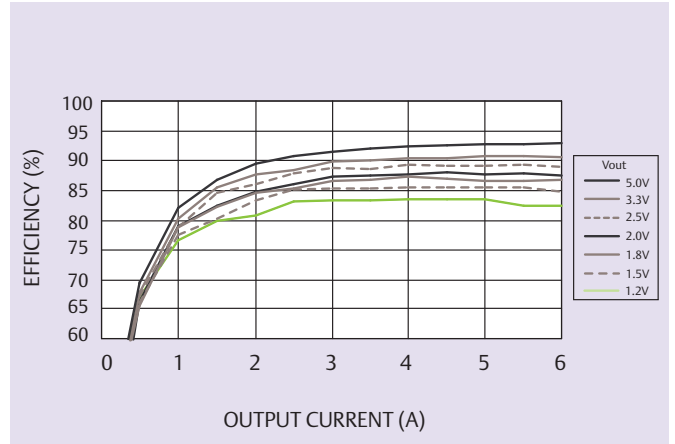

Figure 2 - Efficiency vs Load Current for PTH12050W
Vin = 12 V (See Note B)

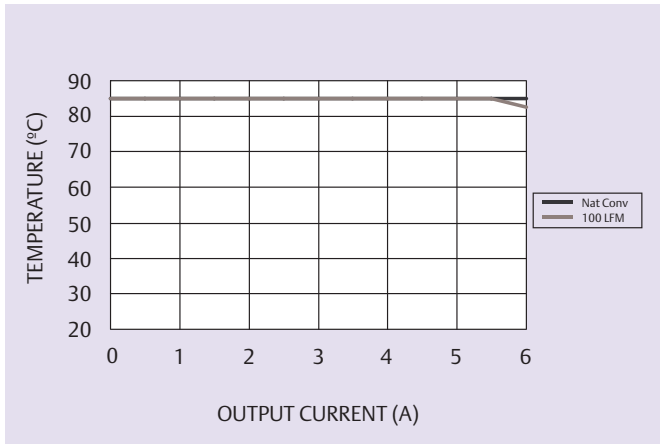

Figure 3 - Safe Operating Area for PTH12050L
Vin = 12 V, Output Voltage = 1.8 V (See Note A)

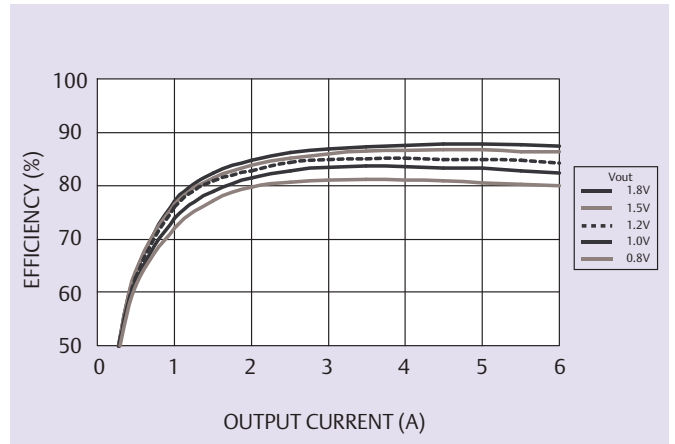

Figure 4 - Efficiency vs Load Current for PTH12050L
Vin = 12 V (See Note B)

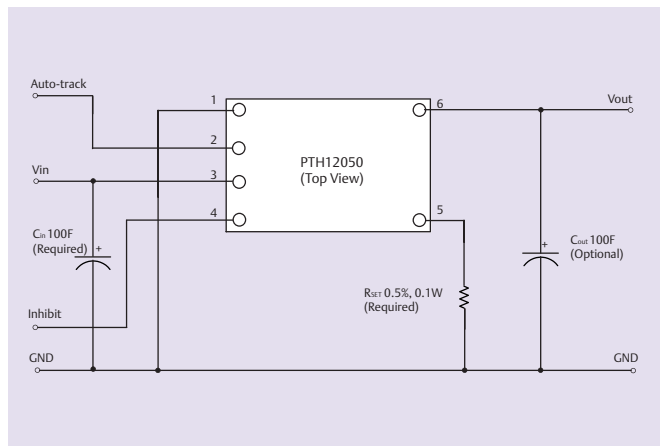

Figure 5 - Standard Application - All Models

Notes

- A SOA curves represent the conditions at which internal components are within the Emerson Network Power derating guidelines.
- B Characteristic data has been developed from actual products tested at 25 °C. This data is considered typical data for the converter.

Mechanical Drawings

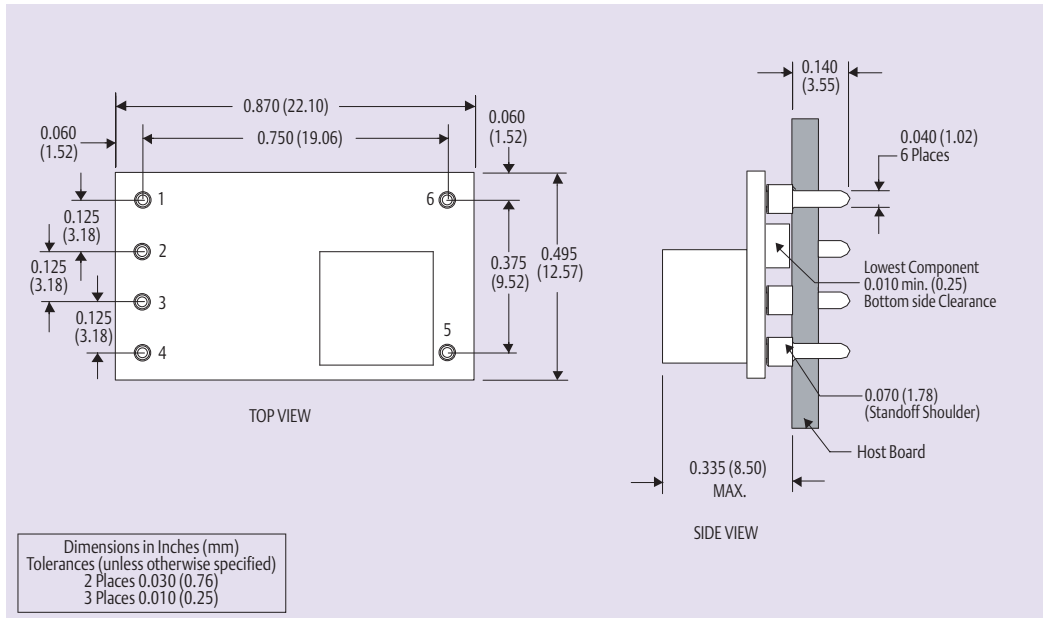

Figure 6 - Plated Through-Hole

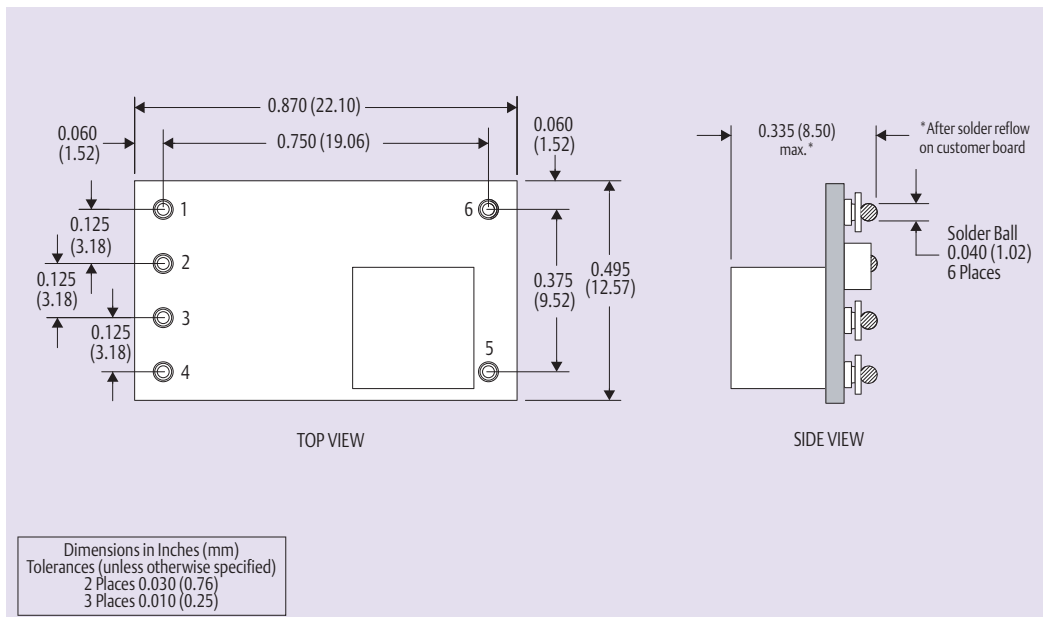

Figure 7 - Surface-Mount

Pin Connections	
Pin No.	Function
Pin 1	Ground
Pin 2	Track
Pin 3	Vin
Pin 4	Inhibit*
Pin 5	Vo adjust
Pin 6	Vout

* Denotes negative logic:
Open = Normal operation
Ground = Function active

Americas

5810 Van Allen Way
Carlsbad, CA 92008
USA
Telephone: +1 760 930 4600
Facsimile: +1 760 930 0698

Europe (UK)

Waterfront Business Park
Merry Hill, Dudley
West Midlands, DY5 1LX
United Kingdom
Telephone: +44 (0) 1384 842 211
Facsimile: +44 (0) 1384 843 355

Asia (HK)

14/F, Lu Plaza
2 Wing Yip Street
Kwun Tong, Kowloon
Hong Kong
Telephone: +852 2176 3333
Facsimile: +852 2176 3888

For global contact, visit:

www.PowerConversion.com

techsupport.embeddedpower@emerson.com

While every precaution has been taken to ensure accuracy and completeness in this literature, Emerson Network Power assumes no responsibility, and disclaims all liability for damages resulting from use of this information or for any errors or omissions.

Emerson Network Power.
The global leader in enabling business-critical continuity.

- AC Power
- Connectivity
- DC Power
- Embedded Computing
- Embedded Power
- Monitoring
- Outside Plant
- Power Switching & Controls
- Precision Cooling
- Racks & Integrated Cabinets
- Services
- Surge Protection

EmersonNetworkPower.com

Emerson Network Power and the Emerson Network Power logo are trademarks and service marks of Emerson Electric Co.
©2008 Emerson Electric Co.

X-ON Electronics

Largest Supplier of Electrical and Electronic Components

Click to view similar products for [Non-Isolated DC/DC Converters](#) category:

Click to view products by [Artesyn Embedded Technologies](#) manufacturer:

Other Similar products are found below :

[PSR152.5-7IR](#) [APTH003A0X-SRZ](#) [SPM1004-3V3C](#) [R-785.0-05](#) [10E24-P15-10PPM](#) [1E24-P4-25PPM-SHV-5KV](#) [CA-17205-L4](#)
[PROPOWER-3.3V](#) [MYGTM01210BZN](#) [40C24-N250-I5-H](#) [40A24-P30-E](#) [3V12-P0.8](#) [10C24-N250-I10-AQ-DA](#) [4AA24-P20-M-H](#) [3V12-](#)
[N0.8](#) [3V24-P1](#) [3V24-N1](#) [BMR4672010/001](#) [BMR4652010/001](#) [6AA24-P30-I5-M](#) [6AA24-N30-I5-M](#) [BM2P101X-Z](#) [35A24-P30](#) [2.5M24-P1](#)
[PTV03010WAD](#) [PTV05020WAH](#) [PTV12010LAH](#) [PTV12020WAD](#) [R-7212D](#) [R-7212P](#) [R-78AA15-0.5SMD](#) [R-78AA5.0-1.0SMD](#) [30A24-](#)
[N15-E](#) [10A12-P4-M](#) [10C24-N250-I5](#) [10C24-P125](#) [10C24-P250-I5](#) [6A24-P20-I10-F-M-25PPM](#) [1A24-P30-F-M-C](#) [TSR 1-24150SM](#)
[1/2AA24-N30-I10](#) [1C24-N125](#) [12C24-N250](#) [V7806-1500](#) [PTV12020LAH](#) [PTV05010WAH](#) [PTN04050CAZT](#) [PTH12020WAD](#)
[PTH12020LAS](#) [PTH05050YAH](#)