



Features

- Low Gate Charge
- Low ON Resistance
- Improved dv/dt Capability
- 100% Avalanche Tested
- RoHS compliant

Applications

- Switching Mode Power Supplies (SMPS)
- PWM Motor Controls
- AC to DC Converters
- LED Lighting
- Adapter

Product Summary

V_{DS}	650	V
$R_{DS(on), Typ @ V_{GS}=10 V}$	0.65	Ω
I_D	12	A

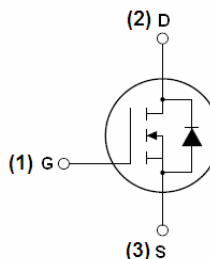

ABSOLUTE MAXIMUM RATINGS ($T_C = 25^\circ\text{C}$, unless otherwise noted)

Parameter	Symbol	Limit	Unit
		TO-220F	
Drain to Source Voltage	V_{DS}	650	V
Continuous Drain Current (@ $T_C=25^\circ\text{C}$)	I_D	12 ⁽¹⁾	A
Continuous Drain Current (@ $T_C=100^\circ\text{C}$)		7.5 ⁽¹⁾	A
Drain current pulsed ⁽²⁾	I_{DM}	48 ⁽¹⁾	A
Gate to Source Voltage	V_{GS}	± 30	V
Single pulsed Avalanche Energy ⁽³⁾	E_{AS}	576	mJ
Peak diode Recovery dv/dt ⁽⁴⁾	dv/dt	5	V/ns
Total power dissipation (@ $T_C=25^\circ\text{C}$)	P_D	24	W
Derating Factor above 25 $^\circ\text{C}$		0.19	W/ $^\circ\text{C}$
Operating Junction Temperature & Storage Temperature	T_{STG}, T_J	-55 to + 150	$^\circ\text{C}$
Maximum lead temperature for soldering purpose	T_L	260	$^\circ\text{C}$

Notes

1. Drain current is limited by maximum junction temperature.
2. Repetitive rating : pulse width limited by junction temperature.
3. $L = 8\text{mH}$, $I_{AS} = 12\text{A}$, $V_{DD} = 50\text{V}$, $R_G = 25\Omega$, Starting at $T_J = 25^\circ\text{C}$
4. $I_{SD} \leq I_D$, $di/dt = 100\text{A/us}$, $V_{DD} \leq BV_{DSS}$, Starting at $T_J = 25^\circ\text{C}$

THERMAL CHARACTERISTICS

Parameter	Symbol	Value	Unit
		TO-220F	
Thermal resistance, Junction to case (Maximum)	R_{thjc}	2.1	$^\circ\text{C/W}$
Thermal resistance, Junction to ambient (Maximum)	R_{thja}	62	$^\circ\text{C/W}$



ELECTRICAL CHARACTERISTICS ($T_C = 25^\circ\text{C}$ unless otherwise specified)						
Parameter	Symbol	Test conditions	Min.	Typ.	Max.	Unit
Off Characteristics						
Drain to source breakdown voltage	BV_{DSS}	$V_{GS}=0V, I_D=250\mu A$	650	--	--	V
Breakdown voltage temperature coefficient	$\Delta BV_{DSS} / \Delta T_J$	$I_D=250\mu A$, referenced to 25°C	--	0.65	--	$V/^\circ\text{C}$
Drain to source leakage current	I_{DSS}	$V_{DS}=650V, V_{GS}=0V$	--	--	1	μA
		$V_{DS}=520V, T_C=125^\circ\text{C}$	--	--	50	μA
Gate to source leakage current, forward	I_{GSS}	$V_{GS}=30V, V_{DS}=0V$	--	--	100	nA
Gate to source leakage current, reverse		$V_{GS}=-30V, V_{DS}=0V$	--	--	-100	nA
On Characteristics						
Gate threshold voltage	$V_{GS(TH)}$	$V_{DS}=V_{GS}, I_D=250\mu A$	2.5	3.5	4.5	V
Drain to source on state resistance	$R_{DS(ON)}$	$V_{GS}=10V, I_D=6A$	--	0.65	0.8	Ω
Forward Transconductance	G_{fs}	$V_{DS}=30V, I_D=6A$	--	9.6	--	S
Dynamic Characteristics						
Input capacitance	C_{iss}	$V_{GS}=0V, V_{DS}=25V, f=1\text{MHz}$	--	1890	--	pF
Output capacitance	C_{oss}		--	144	--	
Reverse transfer capacitance	C_{rss}		--	9.9	--	
Turn on delay time	$t_{d(on)}$	$V_{DS}=325V, I_D=12A, R_G=25\Omega, V_{GS}=10V$	--	33	--	ns
Rising time	t_r		--	41	--	
Turn off delay time	$t_{d(off)}$		--	102	--	
Fall time	t_f		--	37	--	
Total gate charge	Q_g	$V_{DS}=520V, V_{GS}=10V, I_D=12A$	--	38	--	nC
Gate-source charge	Q_{gs}		--	9	--	
Gate-drain charge	Q_{gd}		--	13	--	
Gate Resistance	R_g	$V_{DS}=0V$, Scan F mode	--	1.4	--	Ω
SOURCE TO DRAIN DIODE RATINGS CHARACTERISTICS						
Parameter	Symbol	Test conditions	Min.	Typ.	Max.	Unit
Continuous source current	I_S	Integral reverse p-n Junction diode in the MOSFET	--	--	12	A
Pulsed source current	I_{SM}		--	--	48	A
Diode forward voltage drop.	V_{SD}	$I_S=12A, V_{GS}=0V$	--	--	1.3	V
Reverse recovery time	T_{rr}	$I_S=12A, V_{GS}=0V, dI_F/dt=100A/\mu s$	--	480	--	ns
Reverse recovery Charge	Q_{rr}		--	4.5	--	μC
Peak Reverse Recovery Current	I_{rrm}	$I_S=12A, dI_F/dt=100A/\mu s$	--	18.5	--	A

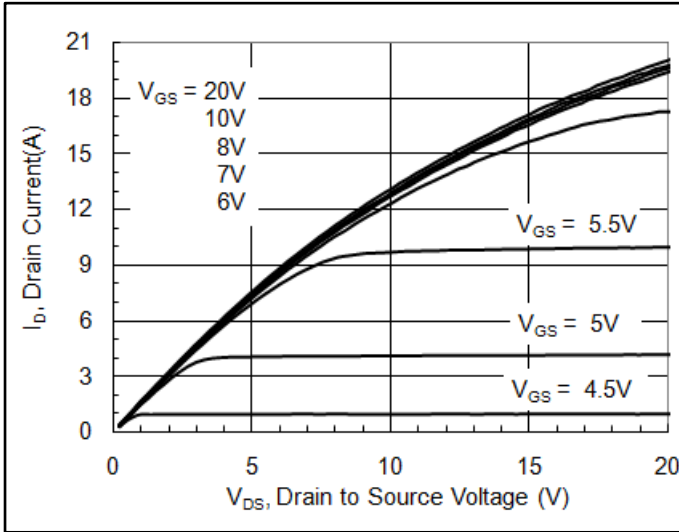

Fig1. Output characteristics

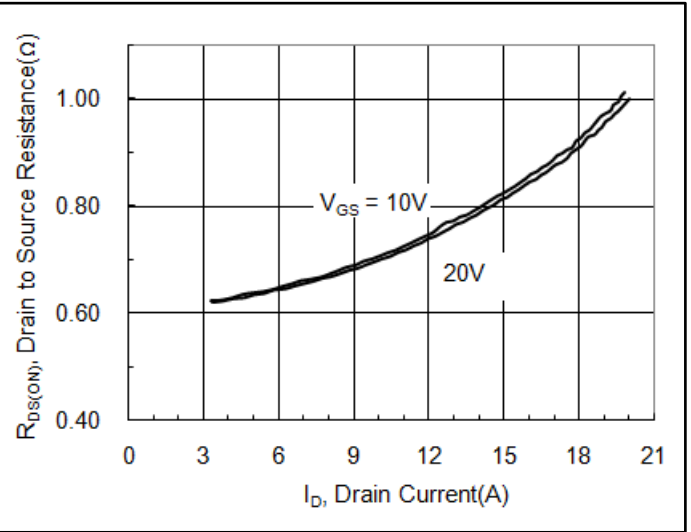

Fig2. Drain-source on-state resistance

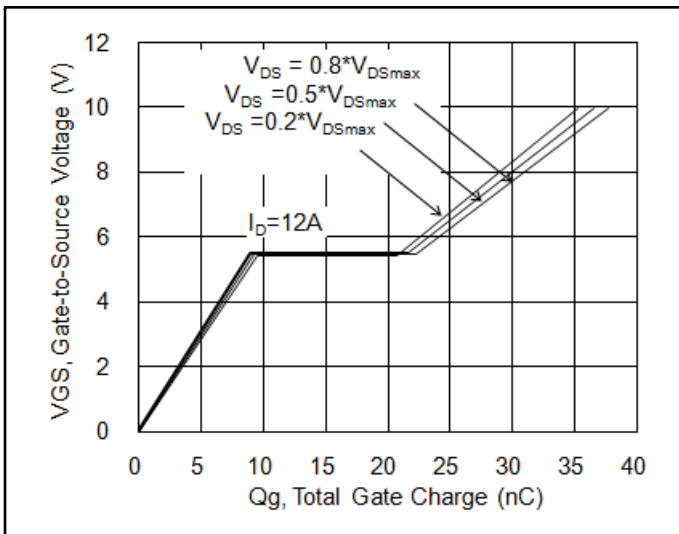

Fig3. Gate charge characteristics

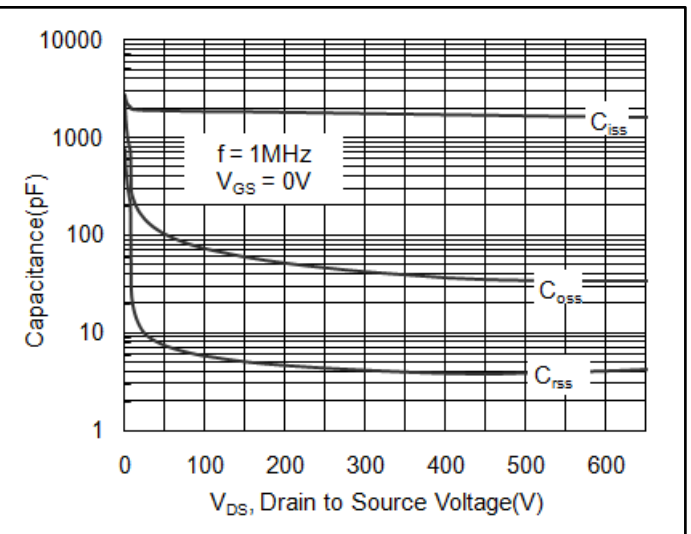

Fig4. Capacitance Characteristics

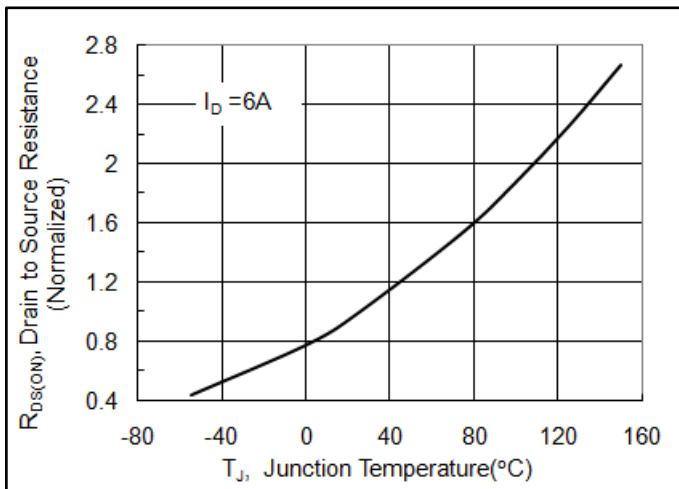

Fig5. $R_{DS(ON)}$ vs junction temperature

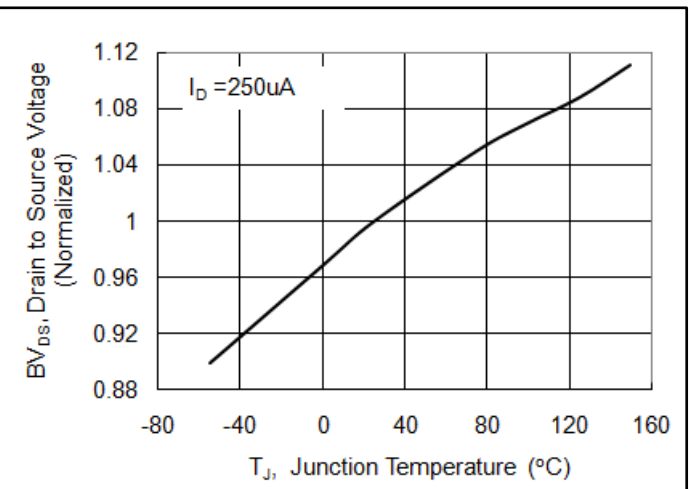

Fig6. BV_{DS} vs junction temperature

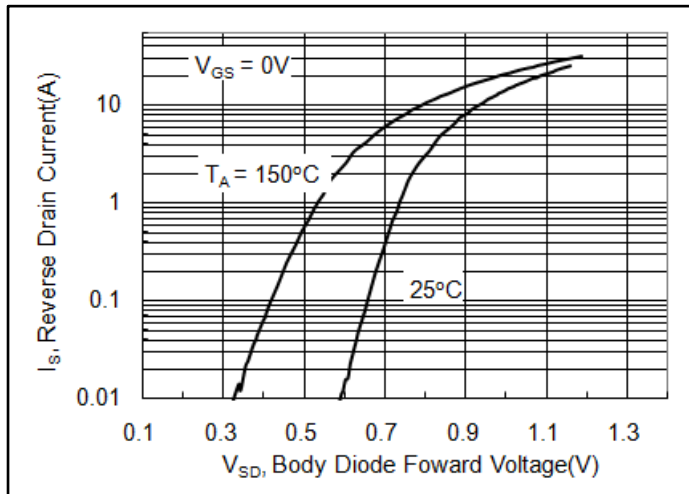

Fig 7. Forward characteristics of reverse diode

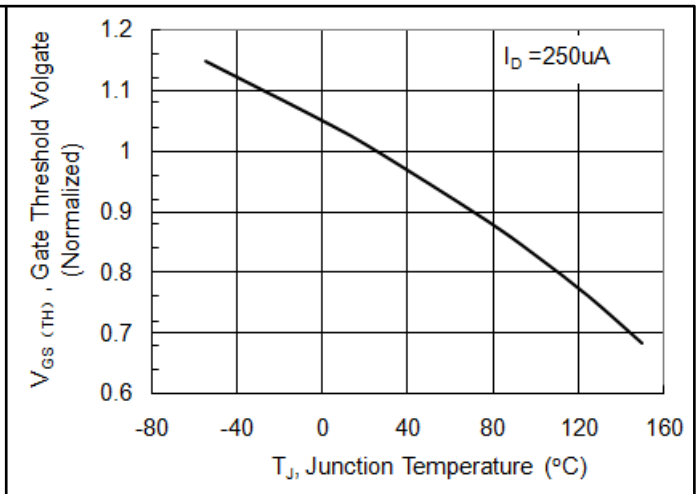

Fig 8. $V_{GS(TH)}$ vs junction temperature

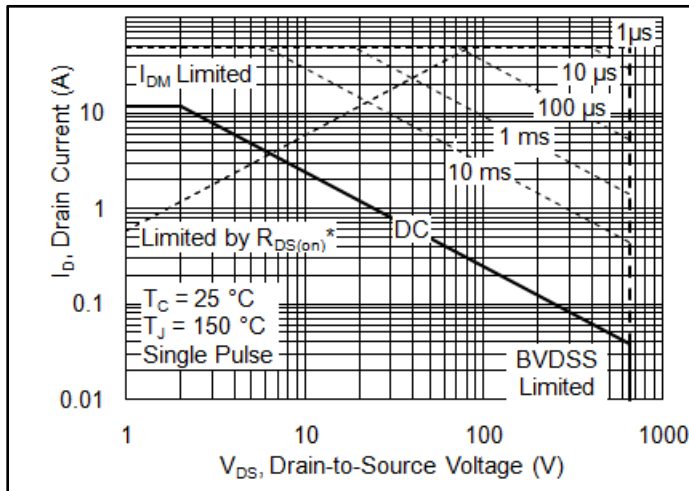

Fig 9. Safe operating area (TO-220F)

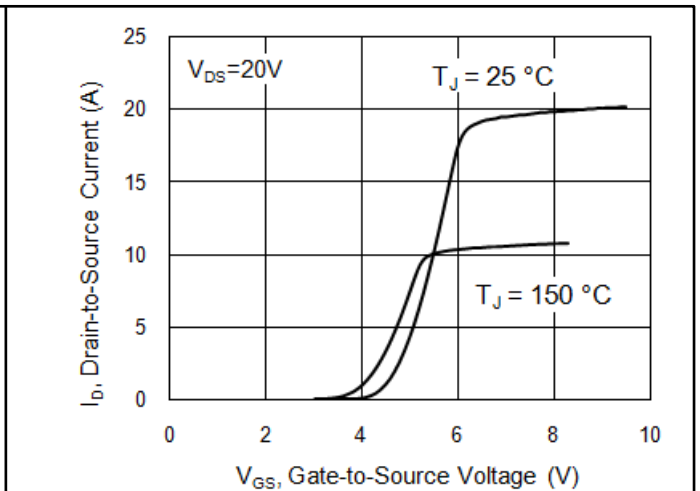

Fig 10. Transfer characteristics

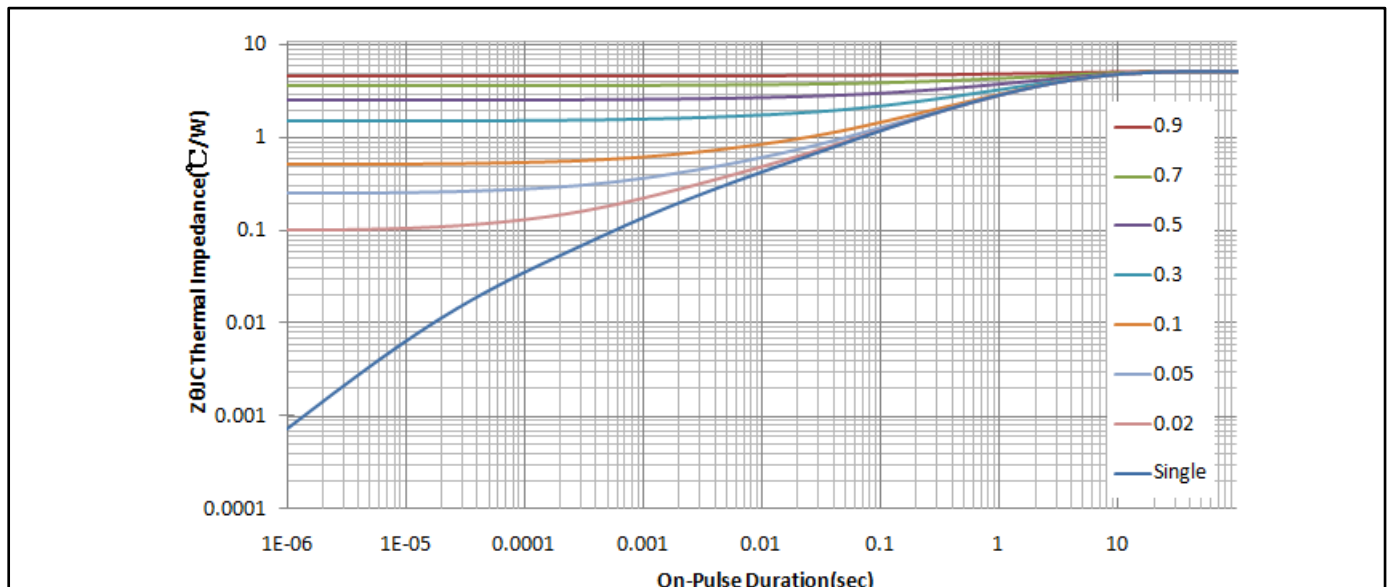

Fig 11. Transient thermal impedance (TO-220F)

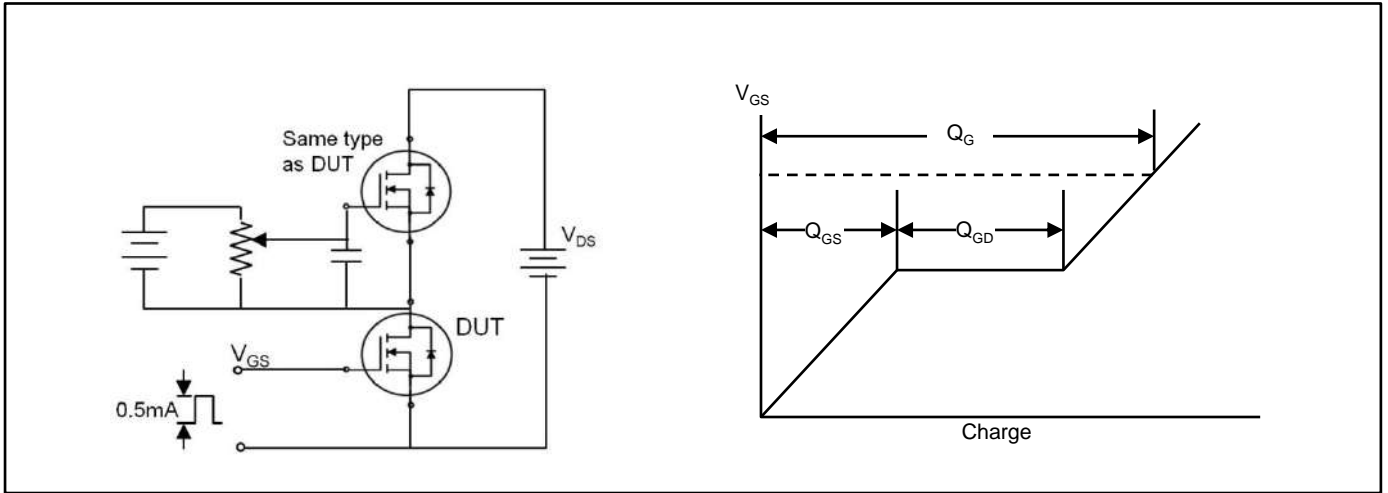

Fig 12. Gate charge test circuit & waveform

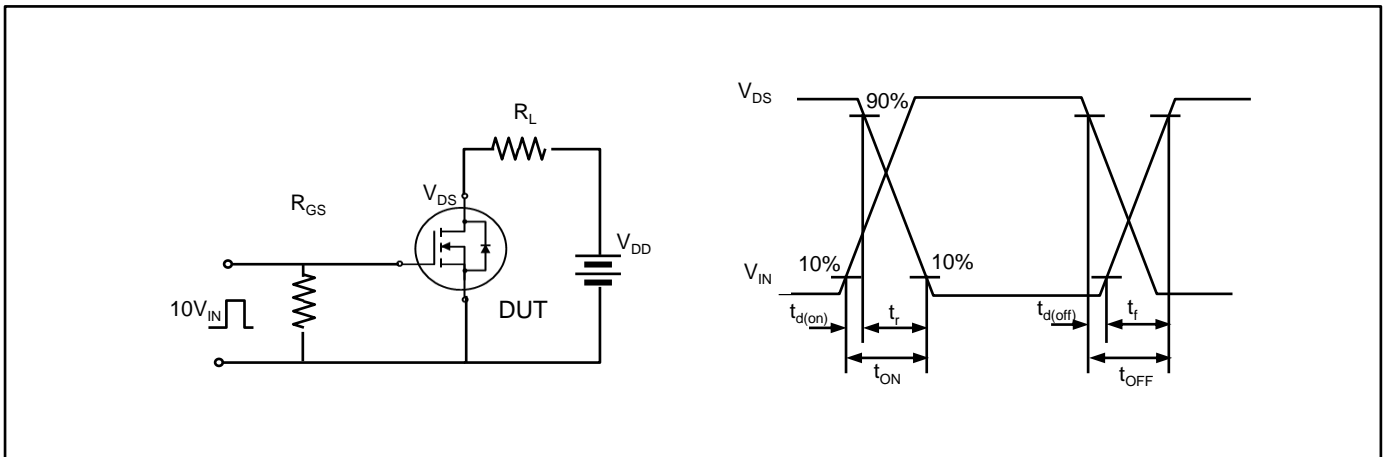

Fig 13. Switching time test circuit & waveform

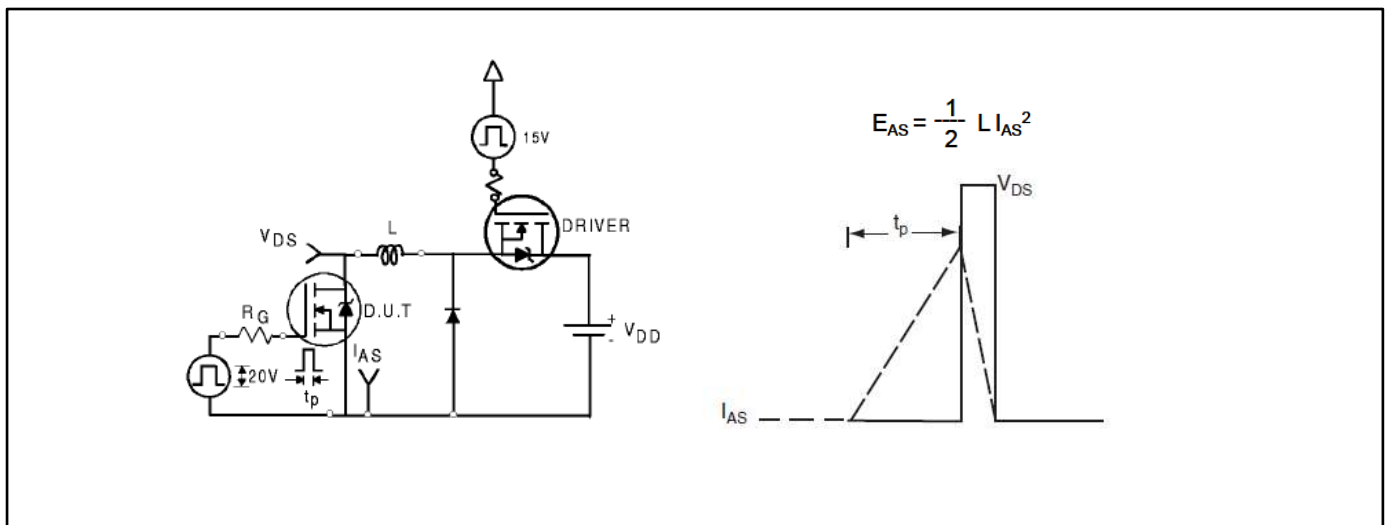

Fig 14. Unclamped Inductive switching test circuit & waveform

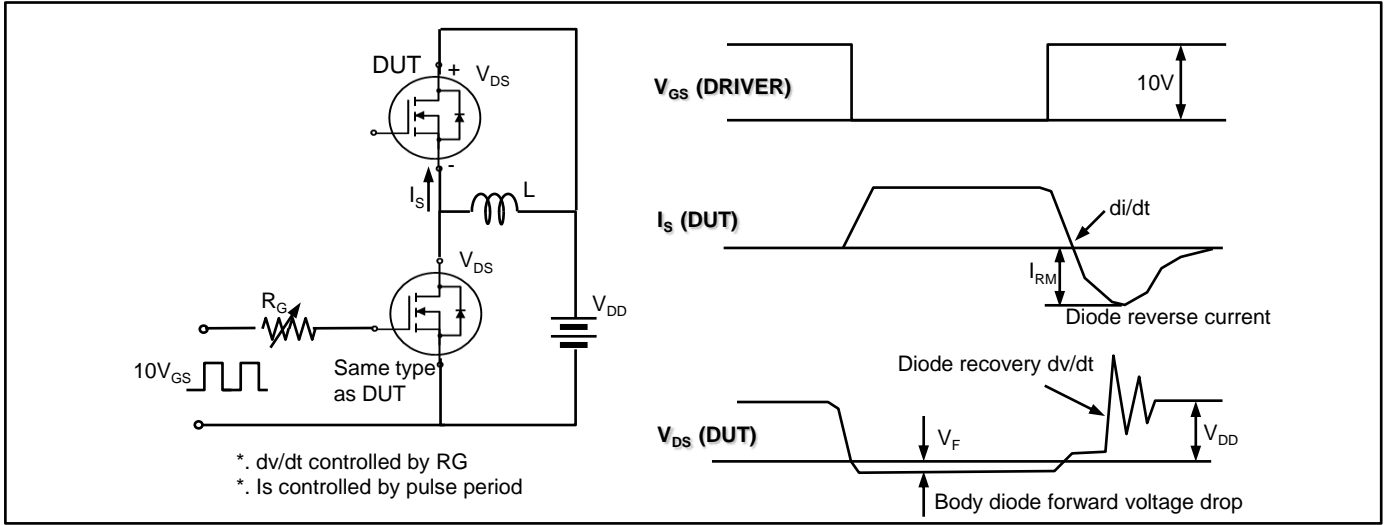
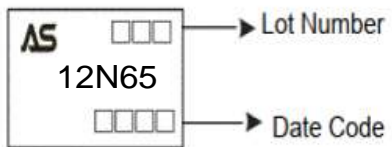

Fig 15. Peak diode recovery dv/dt test circuit & waveform

Ordering and Marking Information

Ordering Device No.	Marking	Package	Packing	Quantity
ASDM12N65F-T	12N65	TO-220F	Tube	50/Tube

PACKAGE	MARKING
TO-220F	 <p>The diagram shows a rectangular marking area on a TO-220F package. It contains the following elements from top to bottom: the 'AS' logo, two empty boxes representing the Lot Number, the part number '12N65', and four empty boxes representing the Date Code. Arrows point from the Lot Number and Date Code boxes to their respective labels.</p>

Package Dimensions

TO-220F

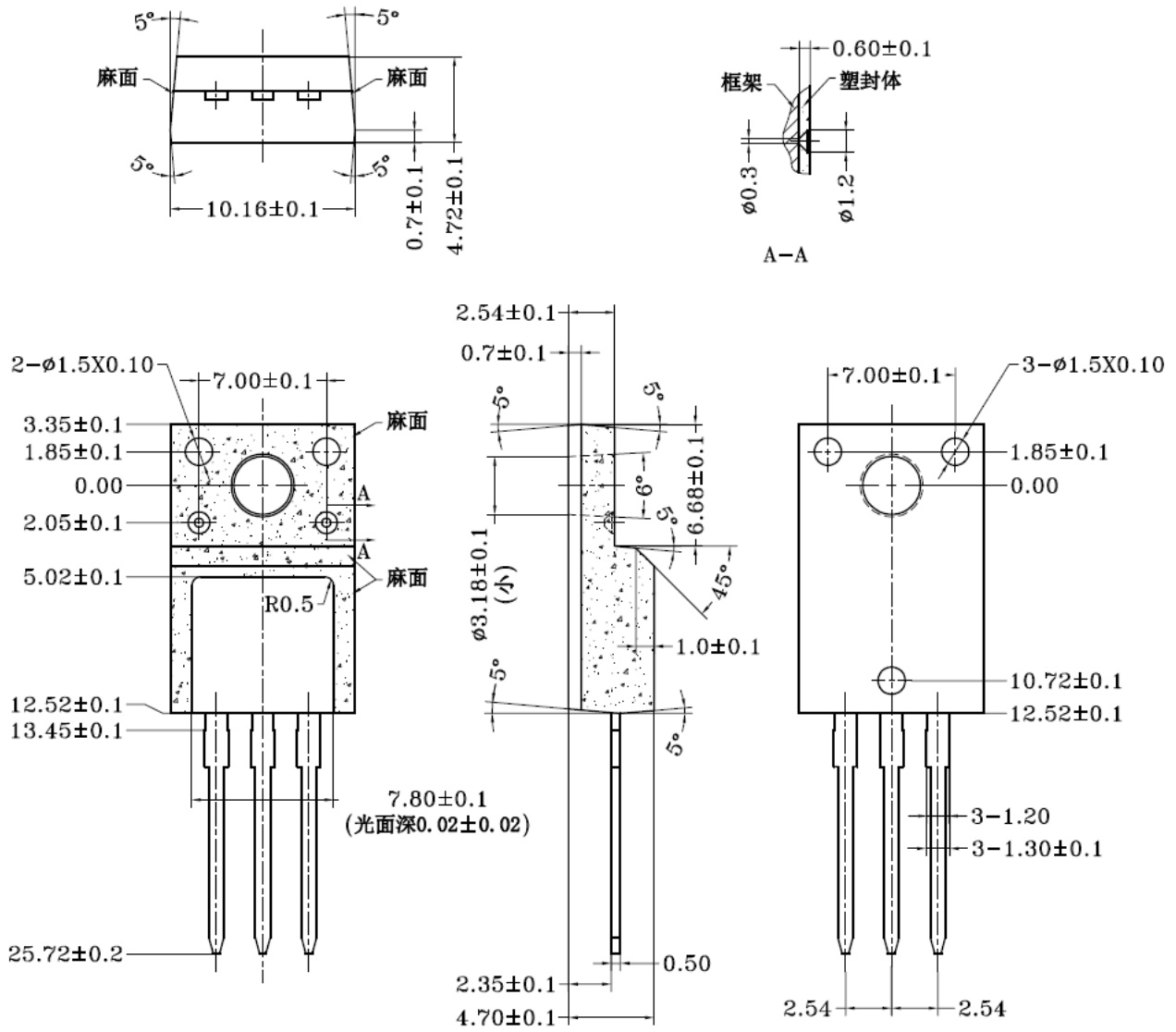



IMPORTANT NOTICE

Xi'an Ascend Semiconductor incorporated MAKES NO WARRANTY OF ANY KIND, EXPRESS OR IMPLIED, WITH REGARDS TO THIS DOCUMENT, INCLUDING, BUT NOT LIMITED TO, THE IMPLIED WARRANTIES OF MERCHANTABILITY AND FITNESS FOR A PARTICULAR PURPOSE (AND THEIR EQUIVALENTS UNDER THE LAWS OF ANY JURISDICTION).

Xi'an Ascend Semiconductor Incorporated and its subsidiaries reserve the right to make modifications, enhancements, improvements, corrections or other changes without further notice to this document and any product described herein. Xi'an Ascend Semiconductor Incorporated does not assume any liability arising out of the application or use of this document or any product described herein; neither does Xi'an Ascend Semiconductor Incorporated convey any license under its patent or trademark rights, nor the rights of others. Any Customer or user of this document or products described herein in such applications shall assume .

all risks of such use and will agree to hold Ascendsemi Incorporated and all the companies whose products are represented on Xi'an Ascend Semiconductor Incorporated website, harmless against all damages.

Xi'an Ascend Semiconductor Incorporated does not warrant or accept any liability whatsoever in respect of any products purchased through unauthorized sales channel. Should Customers purchase or use Xi'an Ascend Semiconductor Incorporated products for any unintended or unauthorized application, Customers shall indemnify and hold Xi'an Ascend Semiconductor Incorporated and its representatives harmless against all claims, damages, expenses, and attorney fees arising out of, directly or indirectly, any claim of personal injury or death associated with such unintended or unauthorized application.

www.ascendsemi.com

X-ON Electronics

Largest Supplier of Electrical and Electronic Components

Click to view similar products for [MOSFET](#) category:

Click to view products by [Ascend](#) manufacturer:

Other Similar products are found below :

[614233C](#) [648584F](#) [IRFD120](#) [IRFF430](#) [JANTX2N5237](#) [2N7000](#) [FCA20N60_F109](#) [FDZ595PZ](#) [AOD464](#) [2SK2267\(Q\)](#) [2SK2545\(Q,T\)](#)
[405094E](#) [423220D](#) [MIC4420CM-TR](#) [VN1206L](#) [614234A](#) [715780A](#) [SSM6J414TU,LF\(T](#) [751625C](#) [PSMN4R2-30MLD](#)
[TK31J60W5,S1VQ\(O](#) [2SK2614\(TE16L1,Q\)](#) [DMN1017UCP3-7](#) [EFC2J004NUZTDG](#) [FCAB21350L1](#) [P85W28HP2F-7071](#) [DMN1053UCP4-7](#)
[NTE2384](#) [NTE2969](#) [NTE6400A](#) [DMN2080UCB4-7](#) [DMN61D9UWQ-13](#) [US6M2GTR](#) [DMN31D5UDJ-7](#) [SSM6P54TU,LF](#) [DMP22D4UFO-](#)
[7B](#) [IPS60R3K4CEAKMA1](#) [DMN1006UCA6-7](#) [DMN16M9UCA6-7](#) [STF5N65M6](#) [STU5N65M6](#) [C3M0021120D](#) [DMN13M9UCA6-7](#)
[BSS340NWH6327XTSA1](#) [MCM3400A-TP](#) [DMTH10H4M6SPS-13](#) [IRF40SC240ARMA1](#) [IPS60R1K0PFD7SAKMA1](#)
[IPS60R360PFD7SAKMA1](#) [IPS60R600PFD7SAKMA1](#)