



### Features

- High Power and current handling capability
- Lead free product is acquired
- Surface Mount Package

### Application

- PWM applications
- Load switch
- Power management

### Product Summary

$V_{DSS}$	$R_{DS(ON)}$ @-4.5V(Typ)	$R_{DS(ON)}$ @-2.5V(Typ)	$I_D$
-20V	65m $\Omega$	83m $\Omega$	-3A

top view

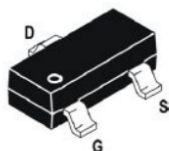

SOT-23

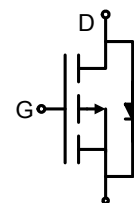
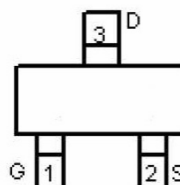

### Absolute Maximum Ratings ( $T_A=25^\circ\text{C}$ unless otherwise noted)

Parameter	Symbol	Limit	Unit
Drain-Source Voltage	$V_{DS}$	-20	V
Gate-Source Voltage	$V_{GS}$	$\pm 10$	V
Drain Current-Continuous	$I_D$	-3	A
Drain Current -Pulsed (Note 1)	$I_{DM}$	-10	A
Maximum Power Dissipation	$P_D$	1	W
Operating Junction and Storage Temperature Range	$T_J, T_{STG}$	-55 To 150	$^\circ\text{C}$

### Thermal Characteristic

Thermal Resistance, Junction-to-Ambient (Note 2)	$R_{\theta JA}$	125	$^\circ\text{C/W}$
--	-----------------	-----	--------------------

### Electrical Characteristics (TA=25°C unless otherwise noted)

Parameter	Symbol	Condition	Min	Typ	Max	Unit
<b>Off Characteristics</b>						
Drain-Source Breakdown Voltage	$BV_{DSS}$	$V_{GS}=0V, I_D=-250\mu A$	-20		-	V
Zero Gate Voltage Drain Current	$I_{DSS}$	$V_{DS}=-20V, V_{GS}=0V$	-	-	-1	$\mu A$
Gate-Body Leakage Current	$I_{GSS}$	$V_{GS}=-10V, V_{DS}=0V$	-	-	-100	nA
<b>On Characteristics (Note 3)</b>						
Gate Threshold Voltage	$V_{GS(th)}$	$V_{DS}=V_{GS}, I_D=-250\mu A$	-0.4	-0.65	-1	V
Drain-Source On-State Resistance	$R_{DS(on)}$	$V_{GS}=-4.5V, I_D=-3A$	-	65	85	m $\Omega$
		$V_{GS}=-2.5V, I_D=-2A$	-	83	120	m $\Omega$
Forward Transconductance	$g_{FS}$	$V_{DS}=-5V, I_D=-2.8A$	-	9.5	-	S
<b>Dynamic Characteristics (Note 4)</b>						
Input Capacitance	$C_{iss}$	$V_{DS}=-10V, V_{GS}=0V,$ $F=1.0MHz$	-	405	-	PF
Output Capacitance	$C_{oss}$		-	75	-	PF
Reverse Transfer Capacitance	$C_{rss}$		-	55	-	PF
<b>Switching Characteristics (Note 4)</b>						
Turn-on Delay Time	$t_{d(on)}$	$V_{DD}=-10V, I_D=-1A$ $V_{GS}=-4.5V, R_{GEN}=10\Omega$	-	11	-	nS
Turn-on Rise Time	$t_r$		-	35	-	nS
Turn-Off Delay Time	$t_{d(off)}$		-	30	-	nS
Turn-Off Fall Time	$t_f$		-	10	-	nS
Total Gate Charge	$Q_g$	$V_{DS}=-10V, I_D=-3A,$ $V_{GS}=-2.5V$	-	3.3	12	nC
Gate-Source Charge	$Q_{gs}$		-	0.7	-	nC
Gate-Drain Charge	$Q_{gd}$		-	1.3	-	nC
<b>Drain-Source Diode Characteristics</b>						
Diode Forward Voltage (Note 3)	$V_{SD}$	$V_{GS}=0V, I_S=1.3A$	-	-	-1.2	V
Diode Forward Current (Note 2)	$I_S$		-	-	-1.3	A

### Notes:

1. Repetitive Rating: Pulse width limited by maximum junction temperature.
2. Surface Mounted on FR4 Board,  $t \leq 10$  sec.
3. Pulse Test: Pulse Width  $\leq 300\mu s$ , Duty Cycle  $\leq 2\%$ .
4. Guaranteed by design, not subject to production

ELECTRICAL AND THERMAL CHARACTERISTICS

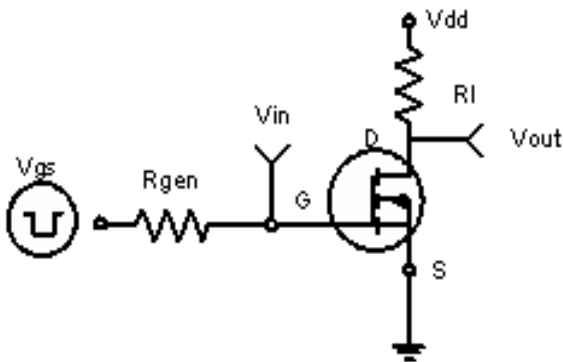

Figure 1: Switching Test Circuit

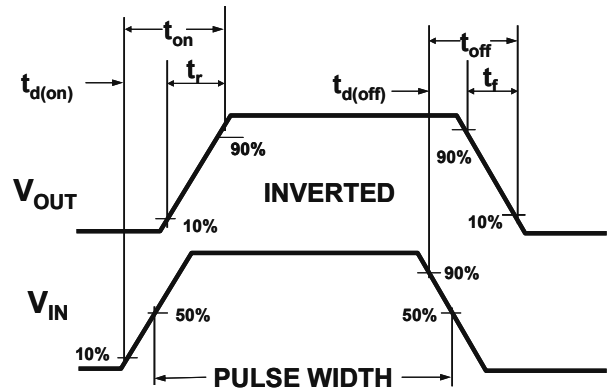

Figure 2: Switching Waveforms

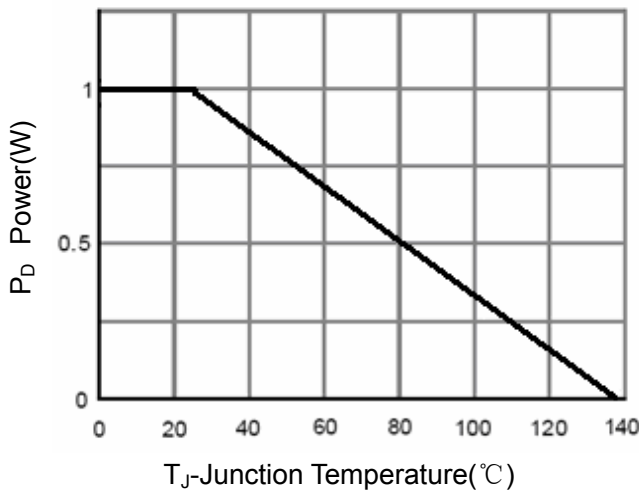

Figure 3 Power Dissipation

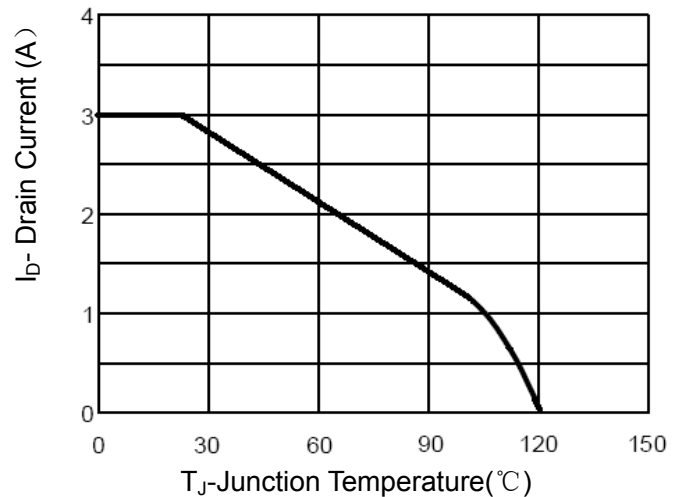

Figure 4 Drain Current

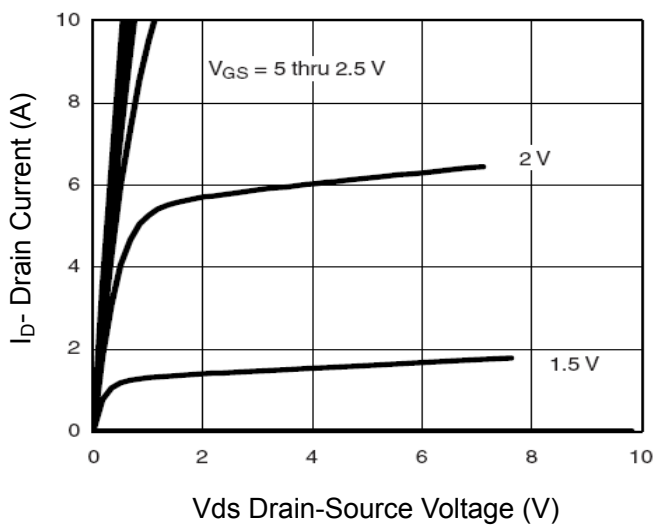

Figure 5 Output CHARACTERISTICS

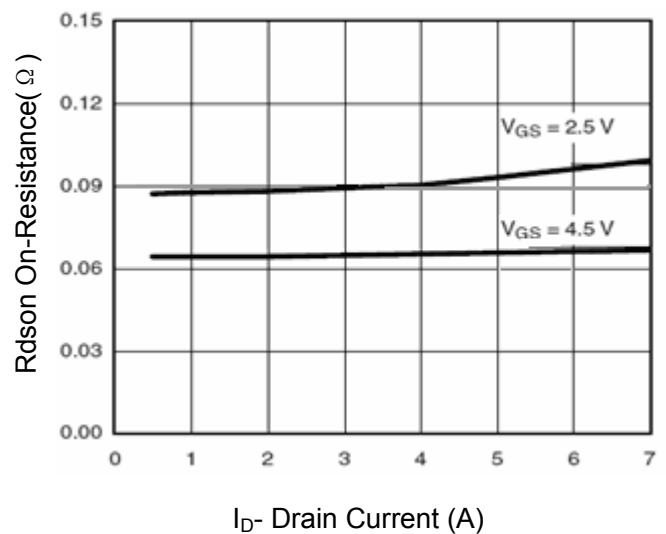

Figure 6 Drain-Source On-Resistance

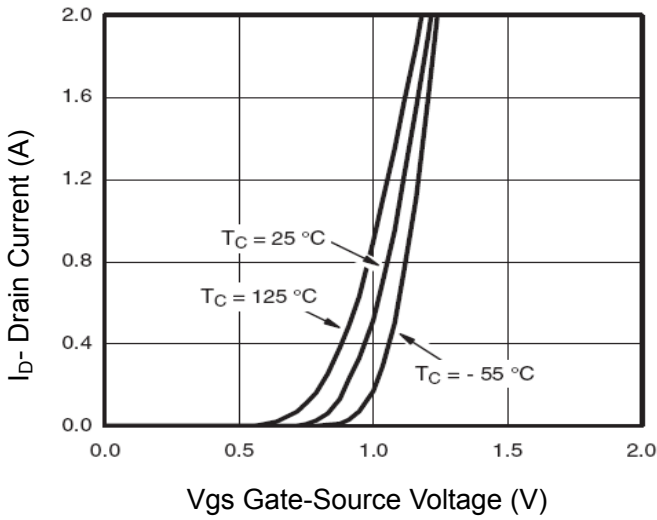

Figure 7 Transfer Characteristics

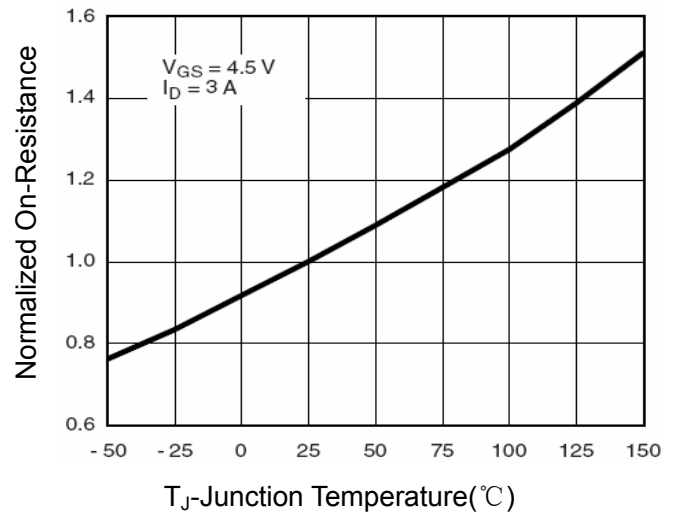

Figure 8 Drain-Source On-Resistance

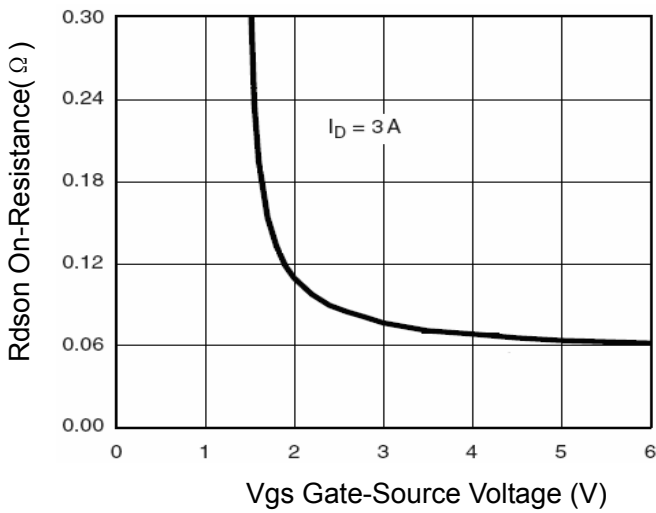

Figure 9 Rdson vs Vgs

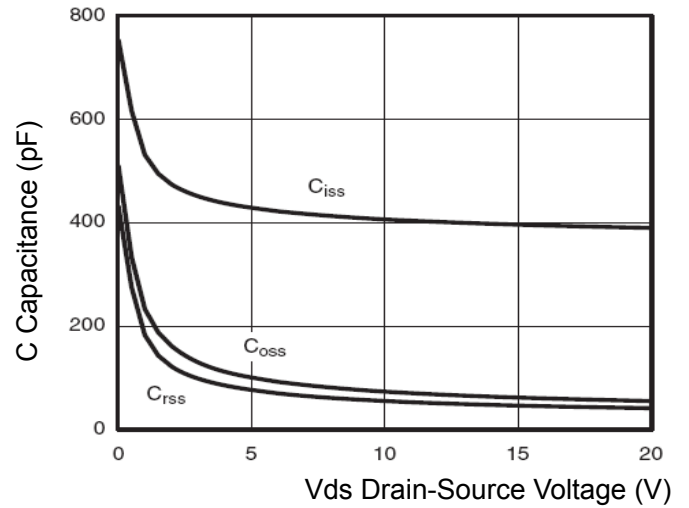

Figure 10 Capacitance vs Vds

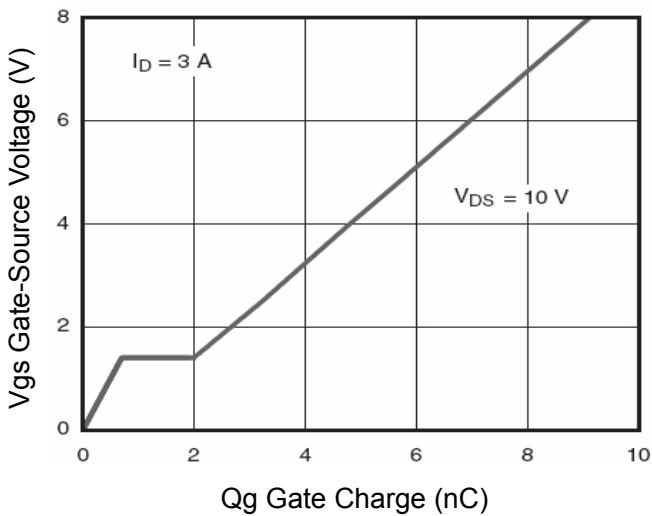

Figure 11 Gate Charge

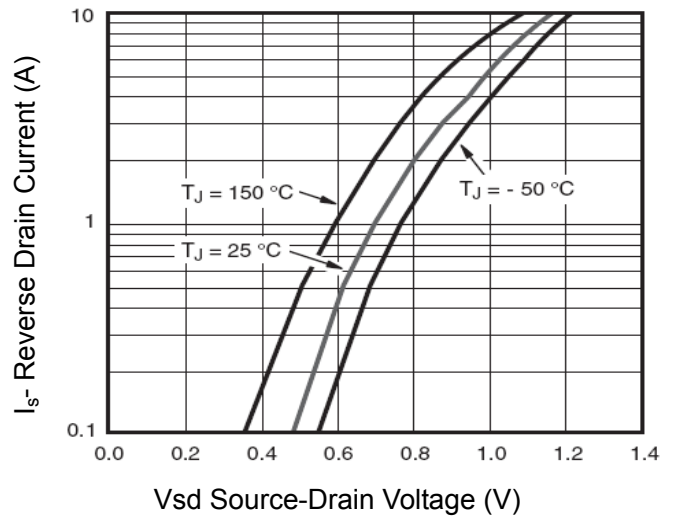
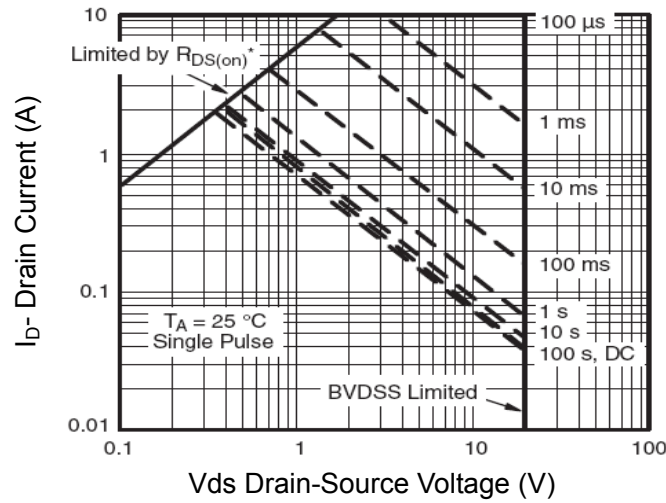
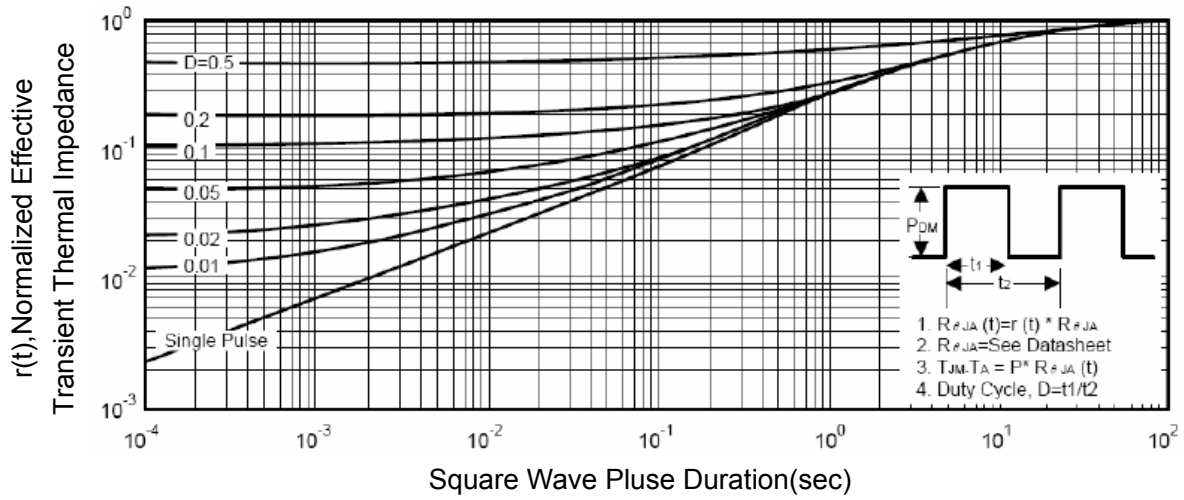

Figure 12 Source- Drain Diode Forward



**Figure 13 Safe Operation Area**



**Figure 14 Normalized Maximum Transient Thermal Impedance**

## Ordering and Marking Information

Device	Marking	Package	Packing	Quantity
ASDM2301ZA	A1SHB	SOT23	Tape&Reel	3000/Reel

PACKAGE	MARKING
SOT23	<div style="border: 1px solid black; padding: 10px; width: fit-content; margin: 0 auto;">A1SHB</div>

Ordering Number		Package
Lead Free	Halogen Free	
ASDM2301-ZA-R	ASDM2301G-ZA-R	SOT23

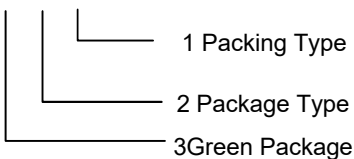
<p>ASDM2301<u>G</u>-<u>ZA</u> -<u>R</u></p>  <p>1 Packing Type 2 Package Type 3 Green Package</p>	<p>1 R:Tape Reel 2 ZA: SOT23 3 blank : Lead Free G:Halogen Free</p>
--	---

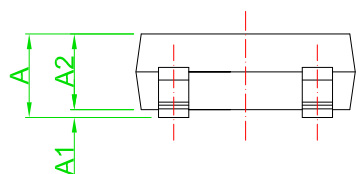
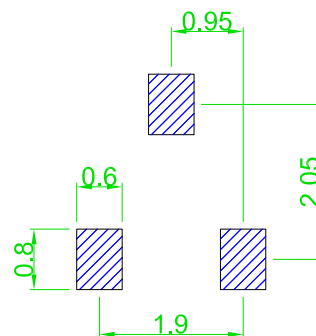
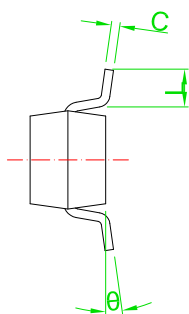
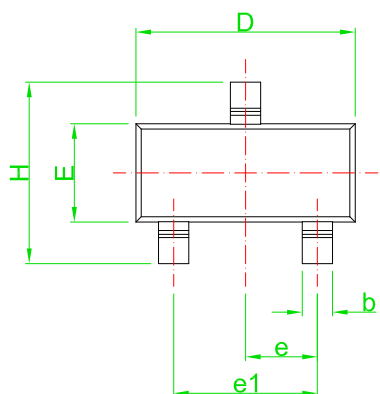

Recommended Land Pattern

Symbol	Dimensions in Millimeters		Dimensions in Inches	
	Min	Max	Min	Max
A	0.90	1.15	0.035	0.045
A1	0.00	0.10	0.000	0.004
A2	0.90	1.05	0.035	0.041
b	0.30	0.55	0.012	0.022
C	0.08	0.15	0.003	0.006
D	2.80	3.00	0.110	0.118
E	1.20	1.40	0.047	0.055
e	0.95 TYP		0.037 TYP	
e1	1.80	2.00	0.071	0.079
H	2.25	2.55	0.089	0.100
L	0.30	0.50	0.012	0.020
$\theta$	0°	8°	0°	8°

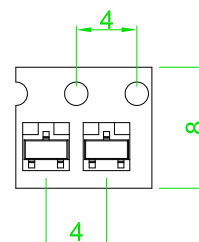

**IMPORTANT NOTICE**

Xi'an Ascend Semiconductor incorporated MAKES NO WARRANTY OF ANY KIND, EXPRESS OR IMPLIED, WITH REGARDS TO THIS DOCUMENT, INCLUDING, BUT NOT LIMITED TO, THE IMPLIED WARRANTIES OF MERCHANTABILITY AND FITNESS FOR A PARTICULAR PURPOSE (AND THEIR EQUIVALENTS UNDER THE LAWS OF ANY JURISDICTION).

Xi'an Ascend Semiconductor Incorporated and its subsidiaries reserve the right to make modifications, enhancements, improvements, corrections or other changes without further notice to this document and any product described herein. Xi'an Ascend Semiconductor Incorporated does not assume any liability arising out of the application or use of this document or any product described herein; neither does Xi'an Ascend Semiconductor Incorporated convey any license under its patent or trademark rights, nor the rights of others. Any Customer or user of this document or products described herein in such applications shall assume

all risks of such use and will agree to hold Ascendsemi Incorporated and all the companies whose products are represented on Xi'an Ascend Semiconductor Incorporated website, harmless against all damages.

Xi'an Ascend Semiconductor Incorporated does not warrant or accept any liability whatsoever in respect of any products purchased through unauthorized sales channel. Should Customers purchase or use Xi'an Ascend Semiconductor Incorporated products for any unintended or unauthorized application, Customers shall indemnify and hold Xi'an Ascend Semiconductor Incorporated and its representatives harmless against all claims, damages, expenses, and attorney fees arising out of, directly or indirectly, any claim of personal injury or death associated with such unintended or unauthorized application.

**[www.ascendsemi.com](http://www.ascendsemi.com)**



## X-ON Electronics

Largest Supplier of Electrical and Electronic Components

*Click to view similar products for [MOSFET](#) category:*

*Click to view products by [Ascend](#) manufacturer:*

Other Similar products are found below :

[614233C](#) [648584F](#) [MCH3443-TL-E](#) [MCH6422-TL-E](#) [FDPF9N50NZ](#) [FW216A-TL-2W](#) [FW231A-TL-E](#) [APT5010JVR](#) [NTNS3A92PZT5G](#)  
[IRF100S201](#) [JANTX2N5237](#) [2SK2464-TL-E](#) [2SK3818-DL-E](#) [FCA20N60\\_F109](#) [FDZ595PZ](#) [STD6600NT4G](#) [FSS804-TL-E](#) [2SJ277-DL-E](#)  
[2SK1691-DL-E](#) [2SK2545\(Q,T\)](#) [D2294UK](#) [405094E](#) [423220D](#) [MCH6646-TL-E](#) [TPCC8103,L1Q\(CM](#) [367-8430-0972-503](#) [VN1206L](#)  
[424134F](#) [026935X](#) [051075F](#) [SBVS138LT1G](#) [614234A](#) [715780A](#) [NTNS3166NZT5G](#) [751625C](#) [873612G](#) [IRF7380TRHR](#)  
[IPS70R2K0CEAKMA1](#) [RJK60S3DPP-E0#T2](#) [RJK60S5DPK-M0#T0](#) [APT5010JVFR](#) [APT12031JFLL](#) [APT12040JVR](#) [DMN3404LQ-7](#)  
[NTE6400](#) [JANTX2N6796U](#) [JANTX2N6784U](#) [JANTXV2N5416U4](#) [SQM110N05-06L-GE3](#) [SIHF35N60E-GE3](#)