

## General Features

- Low Gate Charge
- Advanced Trench Technology
- Provide Excellent RDS(ON)
- High Power and Current Handling Capability

## Application

- Load Switch
- PWM applications
- Power management

## Product Summary



VDS	30	V
RDS(on), Typ. @ VGS=10 V	4.3	mΩ
ID	90	A

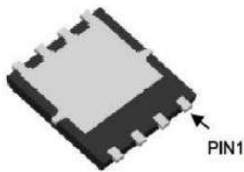

DFN5\*6-8

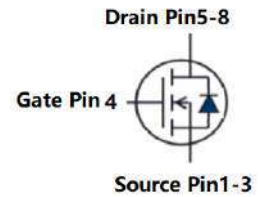
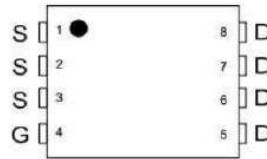

N-Channel

## Absolute Maximum Ratings ( $T_A = 25^\circ\text{C}$ unless otherwise noted)

Parameter	Symbol	Maximum	Units
Drain-Source Voltage	$V_{DS}$	30	V
Gate-Source Voltage	$V_{GS}$	$\pm 20$	V
Continuous Drain Current <sup>B</sup>	$I_D$	$T_C = 25^\circ\text{C}$	90
		$T_C = 100^\circ\text{C}$	40
Pulsed Drain Current <sup>A</sup>	$I_{DM}$	360	A
Avalanche Current <sup>A</sup>	$I_S$	90	A
Single Pulse Avalanche Energy $L = 0.3\text{mH}$ <sup>A</sup>	$E_{AS}$	135	mJ
Power Dissipation <sup>C</sup>	$P_D$	$T_C = 25^\circ\text{C}$	65
		$T_C = 100^\circ\text{C}$	32
Junction and Storage Temperature Range	$T_J, T_{STG}$	-55 to 175	$^\circ\text{C}$
<b>Thermal Characteristics</b>			
Parameter	Symbol	Maximum	Units
Maximum Junction-to-Case	$R_{\theta JC}$	2.3	$^\circ\text{C/W}$
Maximum Junction-to-Ambient			

Electrical Characteristics( $T_J = 25^\circ\text{C}$ unless otherwise noted)							
Symbol	Parameter	Conditions	Value			Units	
			Min	Typ	Max		
<b>STATIC PARAMETERS</b>							
$BV_{DSS}$	Drain-Source Breakdown Voltage	$I_D = 250\mu\text{A}, V_{GS} = 0\text{V}$	30	--	--	V	
$I_{DSS}$	Zero Gate Voltage Drain Current	$V_{DS} = 30\text{V}, V_{GS} = 0\text{V}$	$T_J = 25^\circ\text{C}$	--	--	1	$\mu\text{A}$
			$T_J = 125^\circ\text{C}$	--	--	25	
$I_{GSS}$	Gate-Body Leakage Current	$V_{DS} = 0\text{V}, V_{GS} = \pm 20\text{V}$	--	--	$\pm 100$	nA	
$V_{GS(th)}$	Gate Threshold Voltage	$V_{DS} = V_{GS}, I_D = 250\mu\text{A}$	1	1.6	2.4	V	
$R_{DS(ON)}$	Static Drain-Source On-Resistance	$V_{GS} = 10\text{V}, I_D = 30\text{A}$	--	4.3	5.2	$\text{m}\Omega$	
		$V_{GS} = 4.5\text{V}, I_D = 30\text{A}$	--	6.9	9.0	$\text{m}\Omega$	
$g_{FS}$	Forward Transconductance	$V_{DS} = 10\text{V}, I_D = 20\text{A}$	16	--	--	S	
$V_{SD}$	Diode Forward Voltage	$I_S = 30\text{A}, V_{GS} = 0\text{V}$	--	--	1	V	
$I_S$	Maximum Body-Diode Continuous Current <sup>B</sup>		--	--	90	A	
<b>DYNAMIC PARAMETERS</b>							
$C_{iss}$	Input Capacitance	$V_{GS} = 0\text{V}, V_{DS} = 15\text{V}, f = 1\text{MHz}$	--	2120	--	$\text{pF}$	
$C_{oss}$	Output Capacitance		--	307	--		
$C_{rss}$	Reverse Transfer Capacitance		--	253	--		
<b>SWITCHING PARAMETERS</b>							
$Q_g$	Total Gate Charge	$V_{GS} = 10\text{V}, V_{DS} = 15\text{V}, I_D = 30\text{A}$	--	40	--	nC	
$Q_{gs}$	Gate Source Charge		--	5.4	--		
$Q_{gd}$	Gate Drain Charge		--	9.6	--		
$t_{D(on)}$	Turn-On Delay Time	$V_{GS} = 10\text{V}, V_{DS} = 15\text{V}, I_D = 20\text{A}, R_G = 3\Omega$	--	15	--	ns	
$t_r$	Turn-On Rise Time		--	32	--		
$t_{D(off)}$	Turn-Off Delay Time		--	15	--		
$t_f$	Turn-Off Fall Time		--	12	--		
$t_{rr}$	Body Diode Reverse Recovery Time	$I_F = 30\text{A}, di/dt = 100\text{A}/\mu\text{s}$	--	23	--	ns	
$Q_{rr}$	Body Diode Reverse Recovery Charge		--	48	--	nC	

A. Single pulse width limited by maximum junction temperature.

B. The maximum current rating is package limited.

C. The power dissipation  $P_D$  is based on  $T_{J(MAX)} = 175^\circ\text{C}$ , using junction-to-case thermal resistance, and is more useful in setting the upper dissipation limit for cases where additional heatsinking is used.

**Typical Characteristics**  $T_J = 25^\circ\text{C}$ , unless otherwise noted

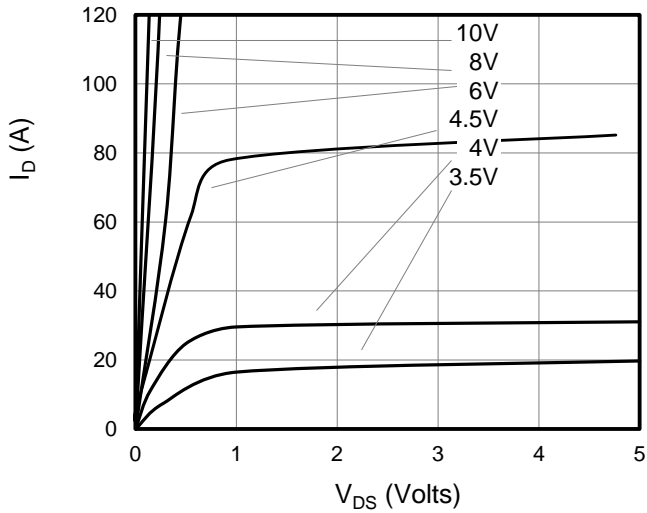

**Figure 1: On-Region Characteristics**

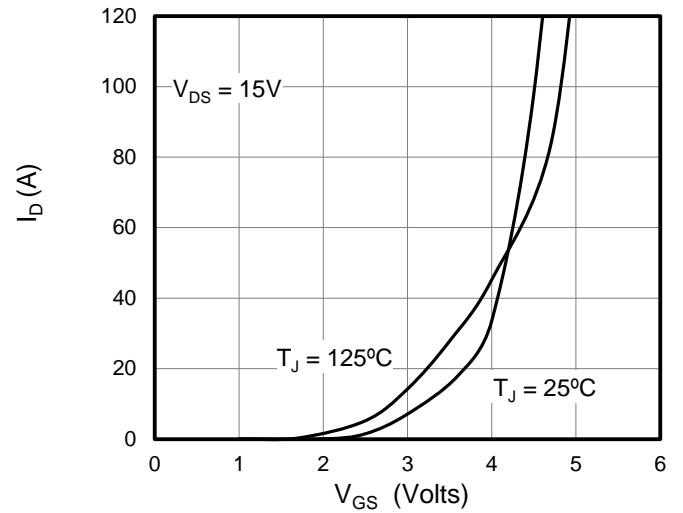

**Figure 2: Transfer Characteristics**

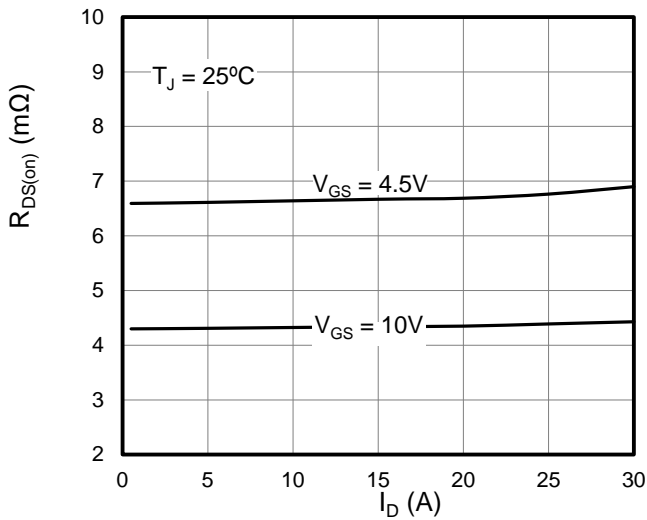

**Figure 3: On-Resistance vs. Drain Current**

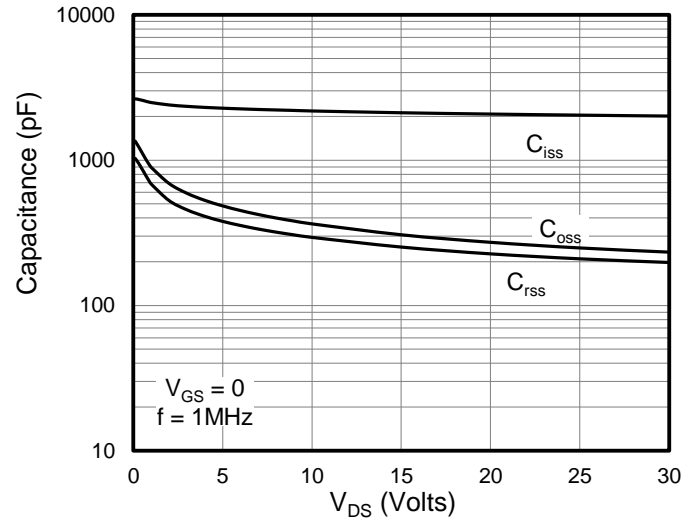

**Figure 4: Capacitance Characteristics**

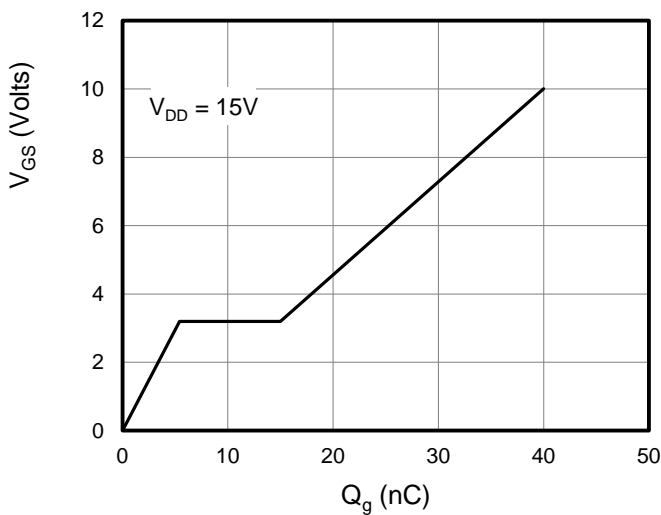

**Figure 5: Gate Charge Characteristics**

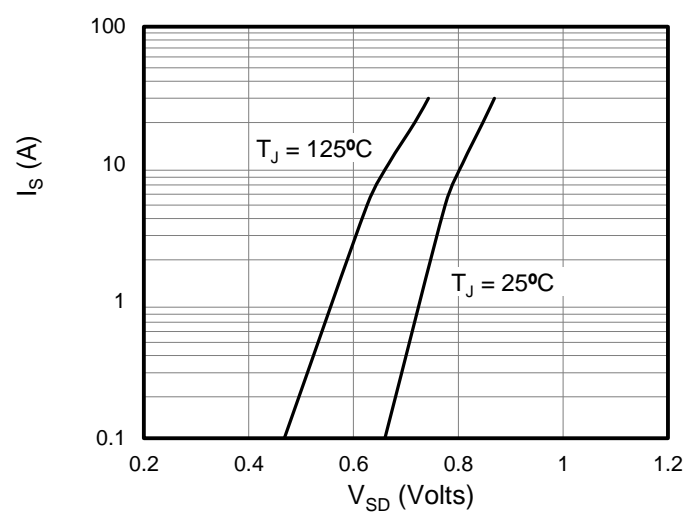

**Figure 6: Body Diode Forward Voltage**

### Typical Characteristics $T_J = 25^\circ\text{C}$ , unless otherwise noted

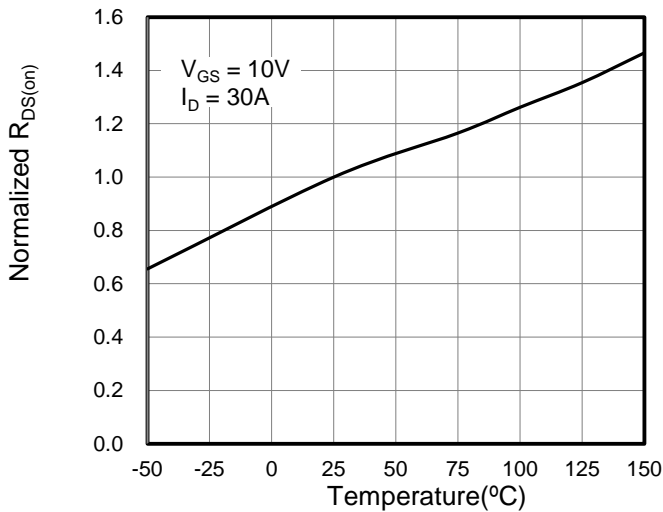

Figure 7: On-Resistance vs. Junction Temperature

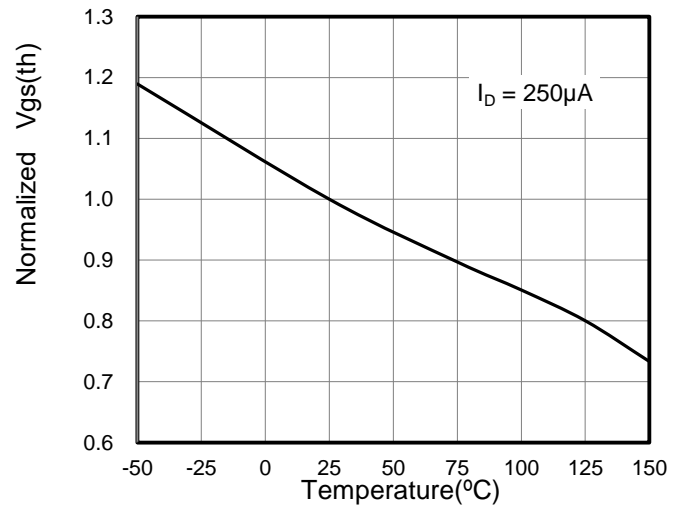

Figure 8:  $V_{GS(th)}$  vs. Junction Temperature

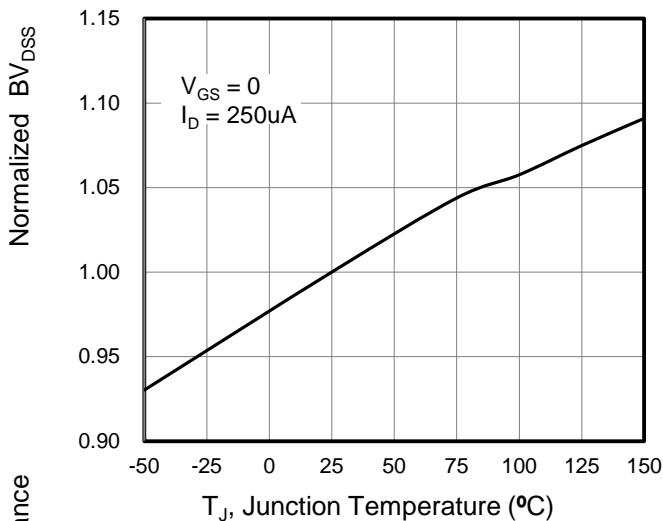

Figure 9:  $BV_{DSS}$  vs. Junction Temperature

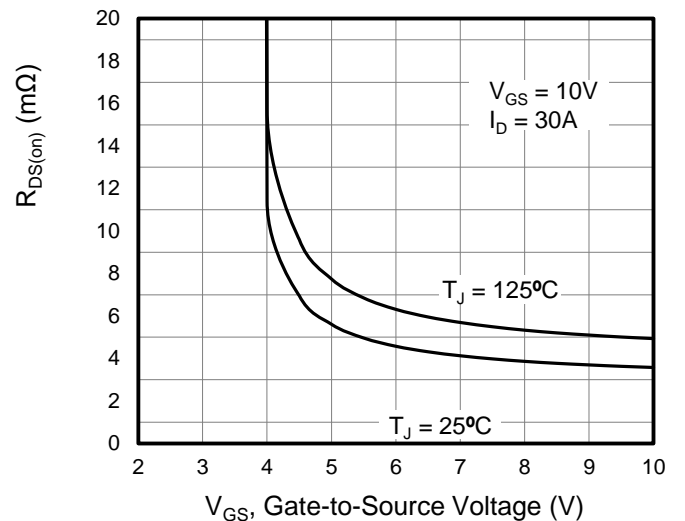

Figure 10: On-Resistance vs. Gate-Source Voltage

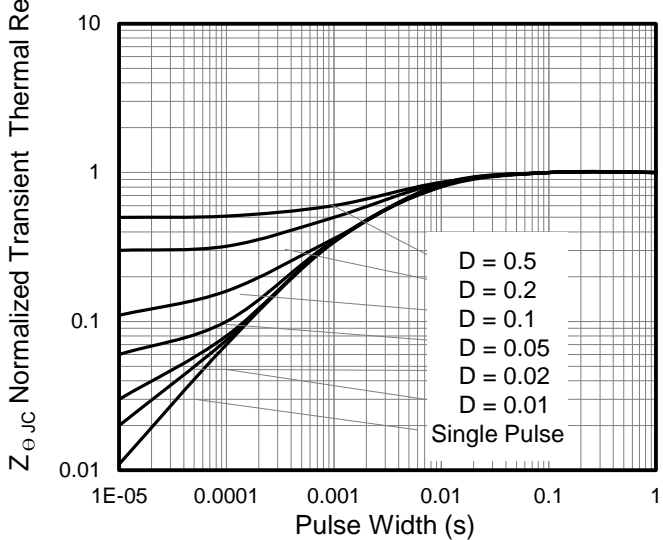

Figure 11: Normalized Transient Thermal Resistance

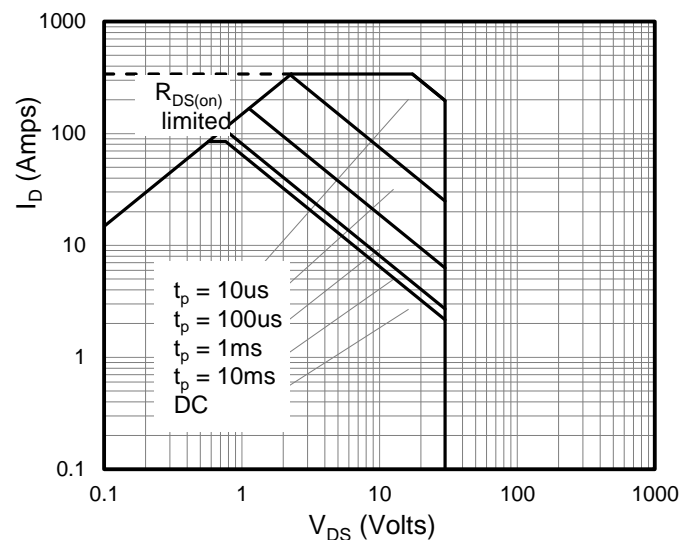

Figure 12: Safe Operating Area

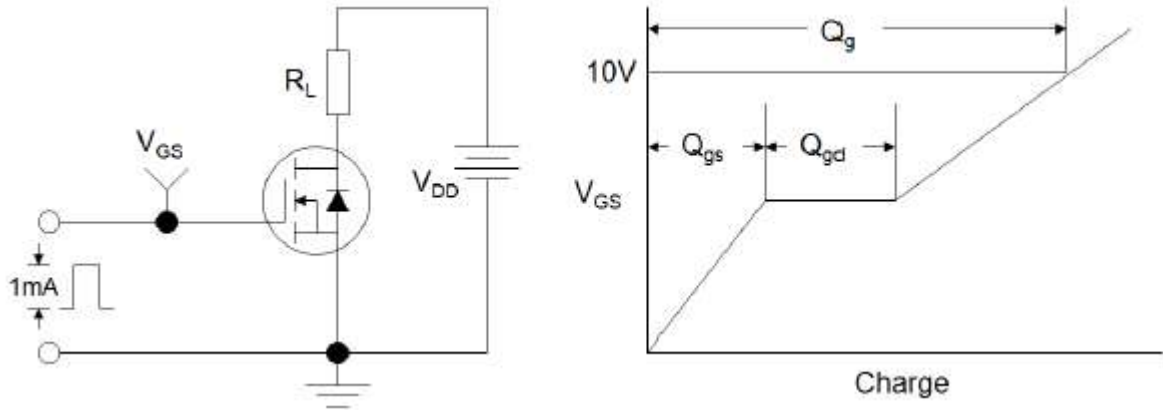

Figure 1: Gate Charge Test Circuit & Waveform

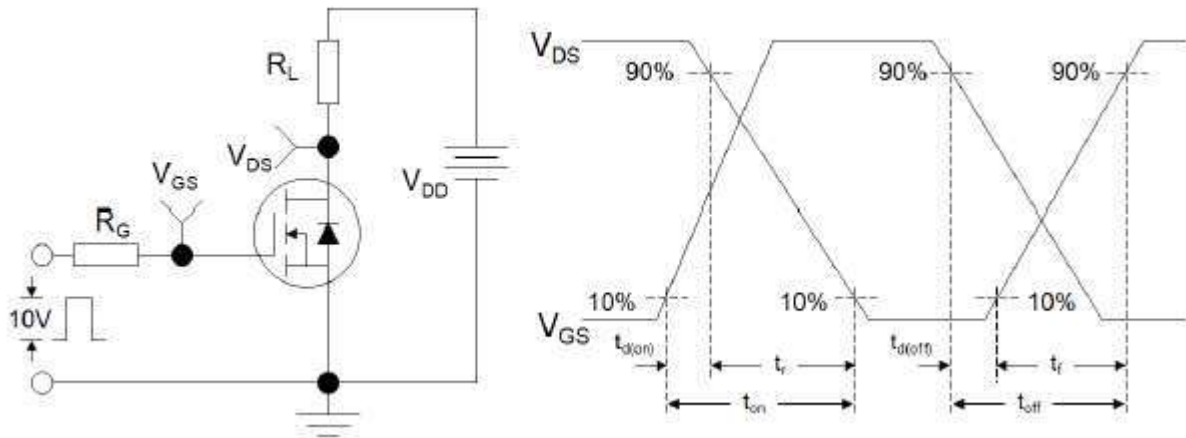

Figure 2: Resistive Switching Test Circuit & Waveforms

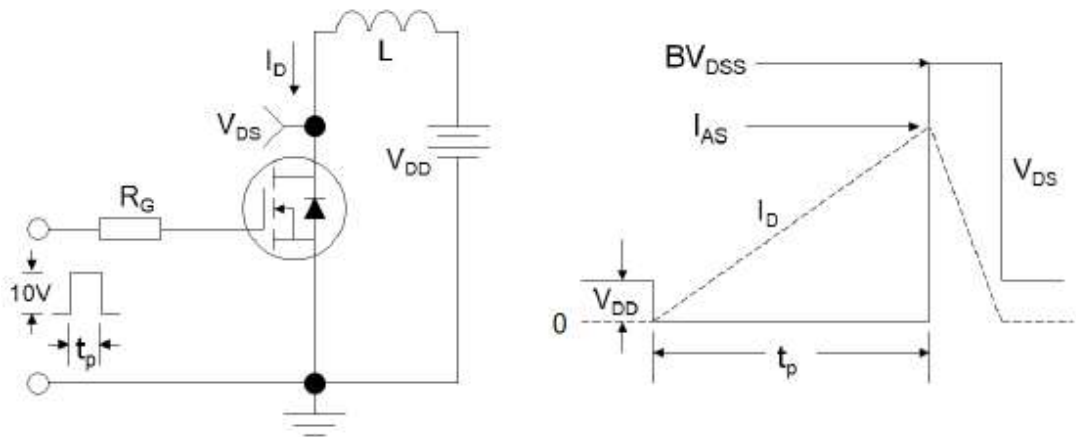

Figure 3: Unclamped Inductive Switching Test Circuit & Waveforms

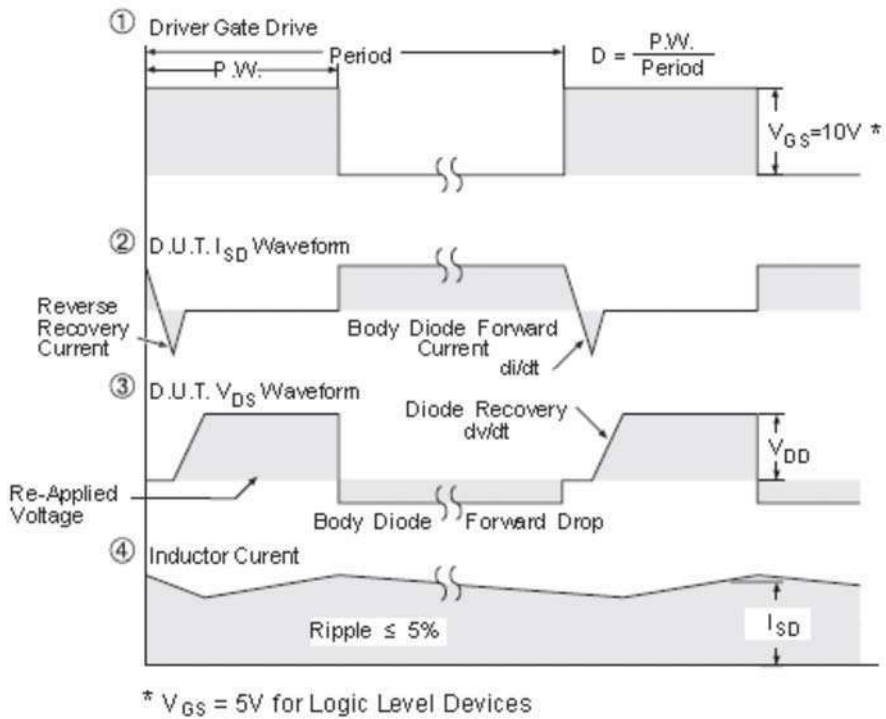
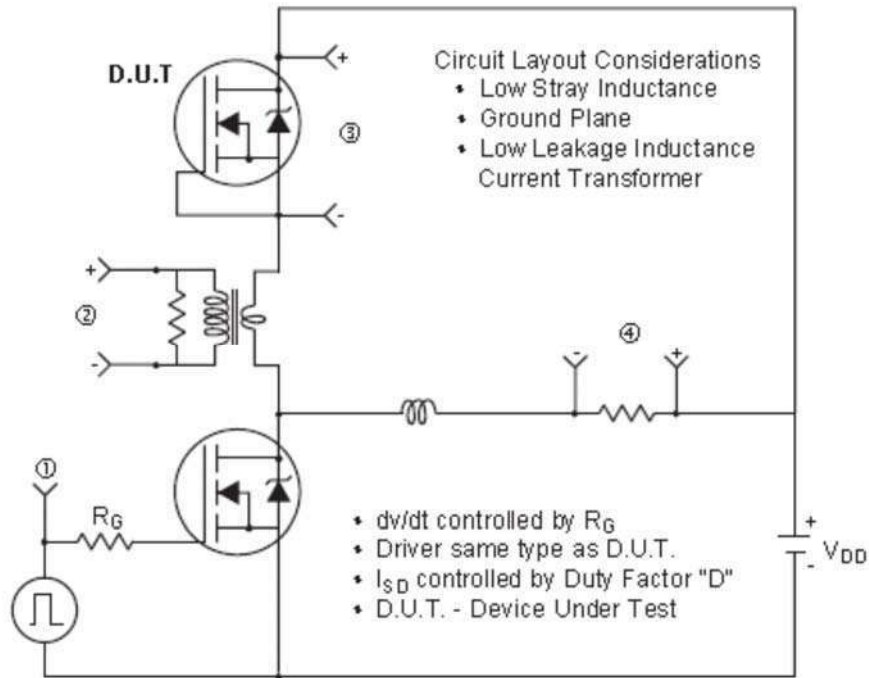
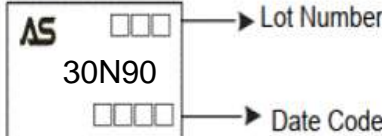

Figure 4: Peak Diode Recovery  $dv/dt$  Test Circuit & Waveforms (For N-channel)

### Ordering and Marking Information

Ordering Device No.	Marking	Package	Packing	Quantity
ASDM30N90Q-R	30N90	DFN5*6-8	Tape&Reel	4000/Reel

PACKAGE	MARKING
DFN5*6-8	 <p>The marking diagram shows a rectangular package with the following markings: 'AS' in the top left corner, '30N90' in the center, and two sets of four small squares. The top set of squares is labeled 'Lot Number' and the bottom set is labeled 'Date Code'.</p>

### DFN5\*6- 8 PACKAGE IN FORMATION

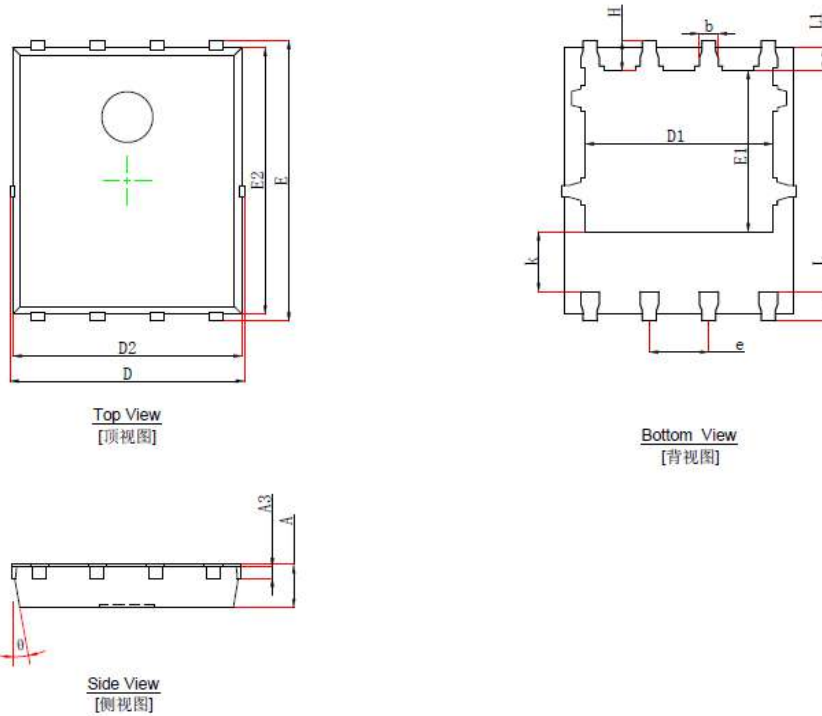

Symbol	Dimensions In Millimeters		Dimensions In Inches	
	Min.	Max.	Min.	Max.
A	0.900	1.000	0.035	0.039
A3	0.254REF.		0.010REF.	
D	4.944	5.096	0.195	0.201
E	5.974	6.126	0.235	0.241
D1	3.910	4.110	0.154	0.162
E1	3.375	3.575	0.133	0.141
D2	4.824	4.976	0.190	0.196
E2	5.674	5.826	0.223	0.229
k	1.190	1.390	0.047	0.055
b	0.350	0.450	0.014	0.018
e	1.270TYP.		0.050TYP.	
L	0.559	0.711	0.022	0.028
L1	0.424	0.576	0.017	0.023
H	0.574	0.726	0.023	0.029
$\theta$	10°	12°	10°	12°



**IMPORTANT NOTICE**

Xi'an Ascend Semiconductor incorporated MAKES NO WARRANTY OF ANY KIND, EXPRESS OR IMPLIED, WITH REGARDS TO THIS DOCUMENT, INCLUDING, BUT NOT LIMITED TO, THE IMPLIED WARRANTIES OF MERCHANTABILITY AND FITNESS FOR A PARTICULAR PURPOSE (AND THEIR EQUIVALENTS UNDER THE LAWS OF ANY JURISDICTION).

Xi'an Ascend Semiconductor Incorporated and its subsidiaries reserve the right to make modifications, enhancements, improvements, corrections or other changes without further notice to this document and any product described herein. Xi'an Ascend Semiconductor Incorporated does not assume any liability arising out of the application or use of this document or any product described herein; neither does Xi'an Ascend Semiconductor Incorporated convey any license under its patent or trademark rights, nor the rights of others. Any Customer or user of this document or products described herein in such applications shall assume

all risks of such use and will agree to hold Ascendsemi Incorporated and all the companies whose products are represented on Xi'an Ascend Semiconductor Incorporated website, harmless against all damages.

Xi'an Ascend Semiconductor Incorporated does not warrant or accept any liability whatsoever in respect of any products purchased through unauthorized sales channel. Should Customers purchase or use Xi'an Ascend Semiconductor Incorporated products for any unintended or unauthorized application, Customers shall indemnify and hold Xi'an Ascend Semiconductor Incorporated and its representatives harmless against all claims, damages, expenses, and attorney fees arising out of, directly or indirectly, any claim of personal injury or death associated with such unintended or unauthorized application.

**[www.ascendsemi.com](http://www.ascendsemi.com)**

## X-ON Electronics

Largest Supplier of Electrical and Electronic Components

*Click to view similar products for [MOSFET](#) category:*

*Click to view products by [Ascend](#) manufacturer:*

Other Similar products are found below :

[614233C](#) [648584F](#) [IRFD120](#) [IRFF430](#) [JANTX2N5237](#) [2N7000](#) [FCA20N60\\_F109](#) [FDZ595PZ](#) [AOD464](#) [2SK2267\(Q\)](#) [2SK2545\(Q,T\)](#)  
[405094E](#) [423220D](#) [MIC4420CM-TR](#) [VN1206L](#) [614234A](#) [715780A](#) [SSM6J414TU,LF\(T](#) [751625C](#) [PSMN4R2-30MLD](#)  
[TK31J60W5,S1VQ\(O](#) [2SK2614\(TE16L1,Q\)](#) [DMN1017UCP3-7](#) [EFC2J004NUZTDG](#) [FCAB21350L1](#) [P85W28HP2F-7071](#) [DMN1053UCP4-7](#)  
[NTE2384](#) [NTE2969](#) [NTE6400A](#) [DMN2080UCB4-7](#) [DMN61D9UWQ-13](#) [US6M2GTR](#) [DMN31D5UDJ-7](#) [SSM6P54TU,LF](#) [DMP22D4UFO-](#)  
[7B](#) [IPS60R3K4CEAKMA1](#) [DMN1006UCA6-7](#) [DMN16M9UCA6-7](#) [STF5N65M6](#) [STU5N65M6](#) [C3M0021120D](#) [DMN13M9UCA6-7](#)  
[BSS340NWH6327XTSA1](#) [MCM3400A-TP](#) [DMTH10H4M6SPS-13](#) [IRF40SC240ARMA1](#) [IPS60R1K0PFD7SAKMA1](#)  
[IPS60R360PFD7SAKMA1](#) [IPS60R600PFD7SAKMA1](#)