

RoHS REACH Compliant

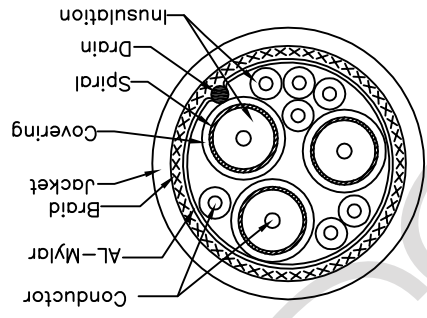

- CABLE: VGA3+7(7/0.10BC+FMP+E+D15/0.12CCA+AL+PVC)*3C+1/0.25BC*7C)+AL+D/0.25BC+96BLMS
OD=7.0±0.20mm JACKET COLOR: BEIGE
CABLE MUST PRINT: AWM 2919 80°C 30V VW-1 LOW VOLTAGE COMPUTER CABLE
- CONNECTOR:
P1&P2: HDB 15P/M, SOLDER, BLUE INSULATION, 3u GOLD PLATED CONTACTS, NICKEL PLATED SHELL
- HOOD: MOLDED TYPE, PVC, 45P, COLOR: BEIGE.
- INSIDE MOLDING: TRANSPARENT PE.
- HEAD: P1&P2 SIDE: 360 SOLDERED COPPER FOIL COVER
- THUMB SCREW: #4-40 UNC, MOLDED TYPE, PVC, 45P, COLOR: BEIGE
- FERRITE CORE: (ø17.5 X ø9.5 X 28.5mm), MOLDED BEIGE PVC.
- ELECTRICAL TEST:
 (1) 100% OPEN SHORT & MIS WIRE TEST.
 (2) CONTACT RESISTANCE 5 ohm Max.
 (3) INSULATION RESISTANCE 10M ohm Min.
 (4) HI-POT TEST: DC 300V/10ms

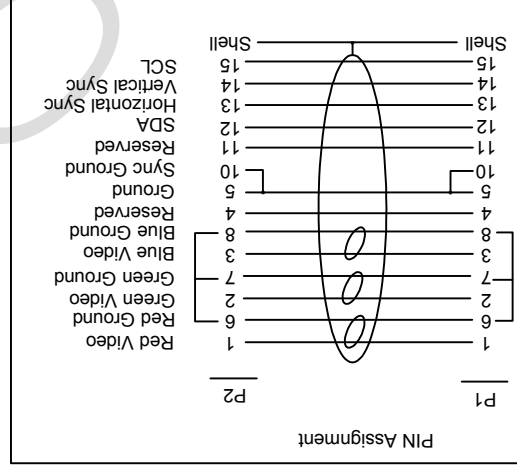
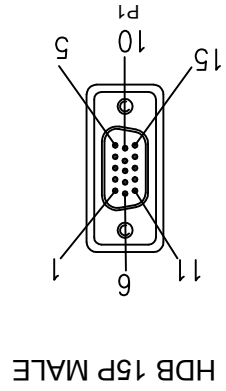
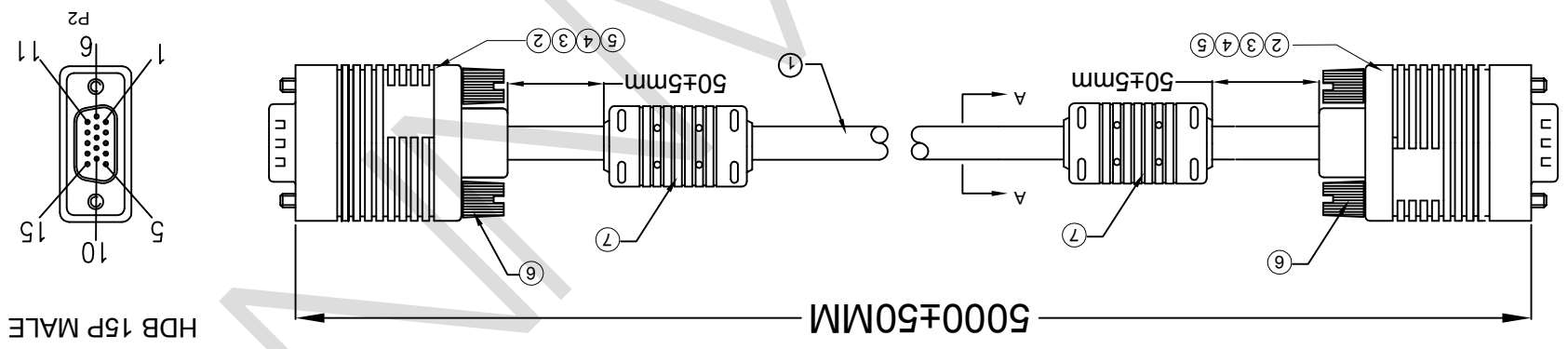

Part No.	AK-310103-050-E		EAN:4016032286691	
	Title			
HDB 15P/M - HDB 15P/M CABLE		Scale		
Sheet 1/2		Unit		MM

ASSMANN
Electronic GmbH

Name	Date	
Susan	April.13,2017	Drawn by
Michael	April.13,2017	Checked by
Jesse	April.13,2017	Approved by

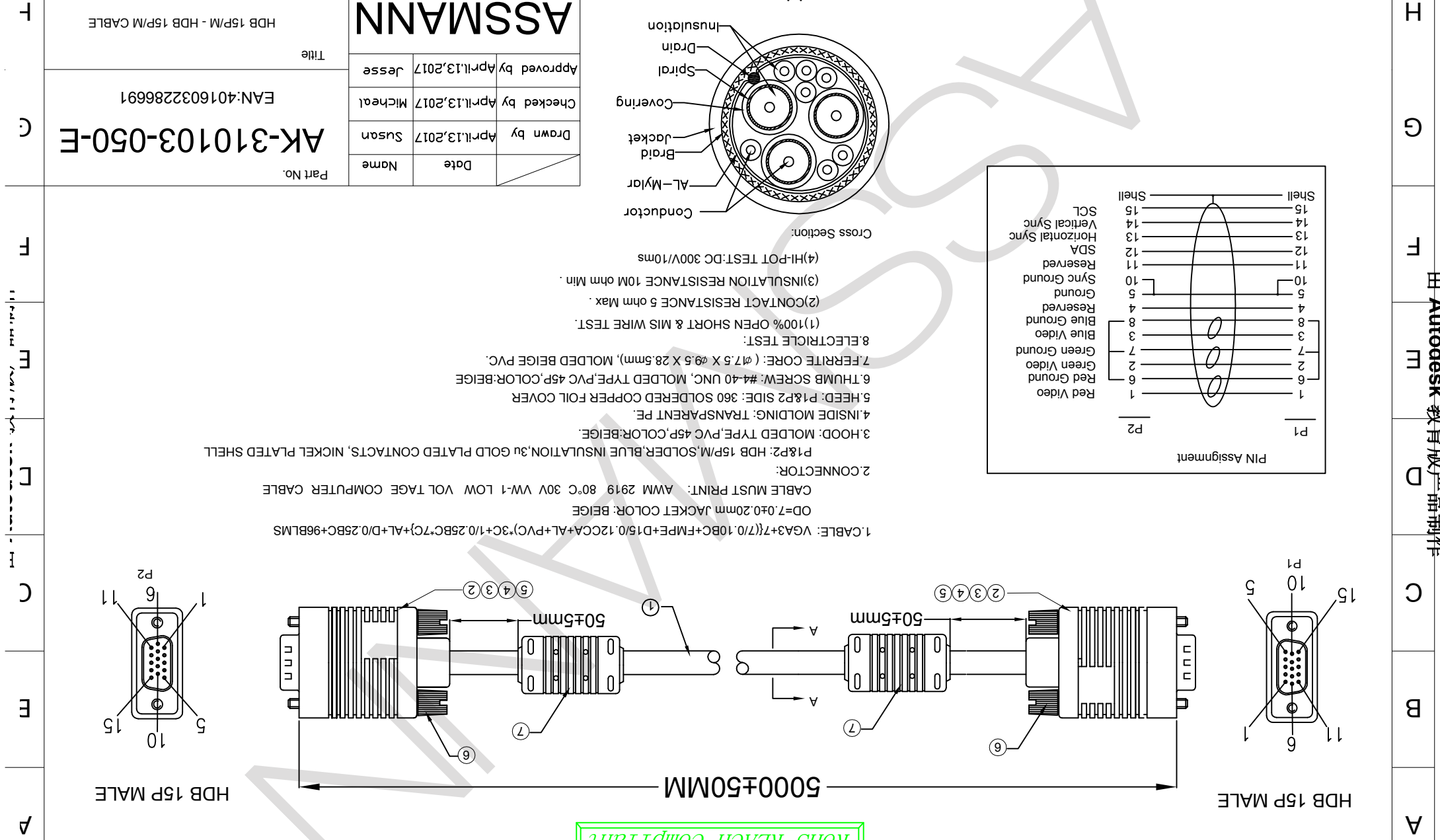

H	Title		Electronic GmbH	
	HDB 15P/M - HDB 15P/M CABLE		ASSMANN	
G	Part No.		Date	Name
	AK-310103-050-E		Approved by	Jesse
	EAN:4016032286691		Checked by	Michael
		Drawn by	Susan	
		Scale	Unit	
		N/A	MM	
		Sheet	2/2	

由 Autodesk 教育版产品制作

* "ROTTERDAM" is for Sea Freight shipment
 * "COLOGNE" is for Air Freight shipment
 * "LUDENSCHIED" is for Fedex or UPS shipment

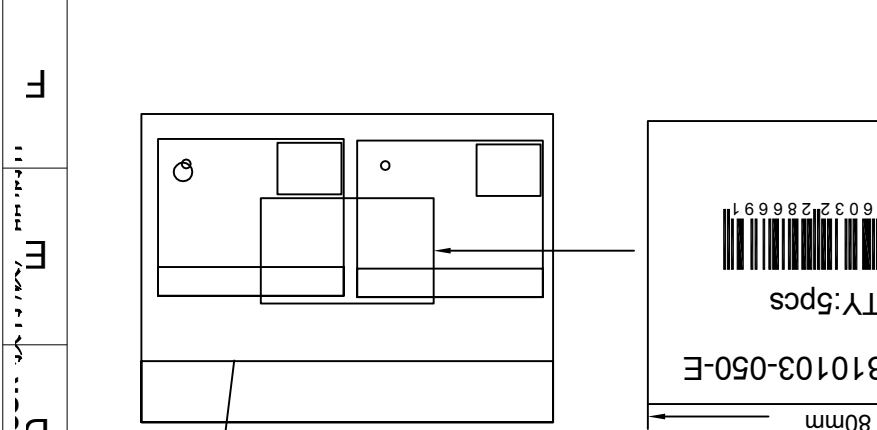

CARTON DETAILS

P/N	AK-310103-050-E	Cable Length	5m	Quantity (Carton)	20pcs	Measurement (Carton)	38*28*24cm	N.W. (Carton)	7.8kg	G.W. (Carton)	8.6kg
-----	-----------------	--------------	----	-------------------	-------	----------------------	------------	---------------	-------	---------------	-------

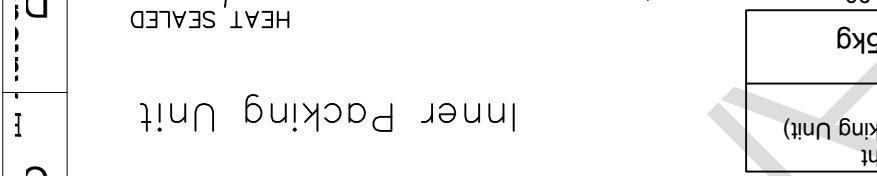

Inner Packing Unit

P/N	AK-310103-050-E	Cable Length	5m	Quantity (Inner Packing Unit)	5 pcs	Type (Inner Packing Unit)	Polybag (Heat Sealed)	Size (Inner Packing Unit)	38*49*0.8mm	Weight (Inner Packing Unit)	1.95kg
-----	-----------------	--------------	----	-------------------------------	-------	---------------------------	-----------------------	---------------------------	-------------	-----------------------------	--------

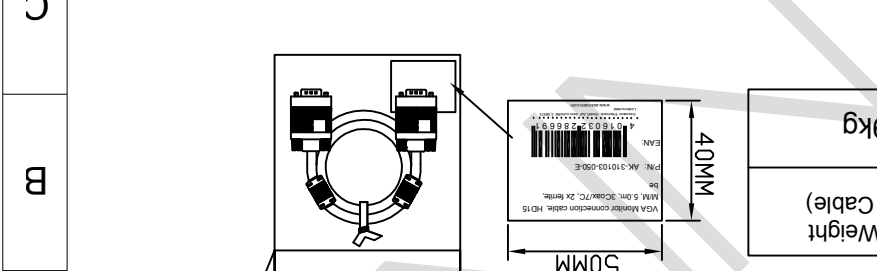

Single Cable

P/N	AK-310103-050-E	Cable Length	5m	Rolling Size (Single Cable)	150mm max.	Polybag Type (Single Cable)	Ordinary Polybag (Heat Sealed)	Bag Size (Single Cable)	23*27*0.8mm	Article Weight (Single Cable)	0.39kg
-----	-----------------	--------------	----	-----------------------------	------------	-----------------------------	--------------------------------	-------------------------	-------------	-------------------------------	--------

Single Cable

Package Details

RoHS REACH Compliant

由 Autodesk 教育版产品制作

X-ON Electronics

Largest Supplier of Electrical and Electronic Components

Click to view similar products for [Computer Cables](#) category:

Click to view products by [Assmann](#) manufacturer:

Other Similar products are found below :

[68809-0004](#) [8F36-AAA105-1.00](#) [IB63](#) [IB68](#) [CBK-11-290K-00](#) [ACL-10568-5](#) [426090200-3](#) [427522400-3](#) [IB76](#) [CB-3PSATA-RS](#)
[426091300-3](#) [48000023](#) [10114976-P015002LF](#) [88761-6101](#) [NT631C-CN321-EU](#) [1700009397](#) [MIKROE-2092](#) [PCL-10488-2E](#) [1700009405](#)
[PS/2 Cable](#) [AXXSTFPCBLKIT](#) [NT31C-CN323-EU](#) [FWAX-PK1-51](#) [68801-1905](#) [2404774](#) [SATA Power to B4P cable](#) [68801-0630](#) [68801-](#)
[3612](#) [68801-3618](#) [0685610020](#) [0745063002](#) [0745460813](#) [0745461605](#) [0745470304](#) [0887505318](#) [0887511310](#) [0DT60002](#) [C-PS2WG/5](#) [C-](#)
[PS2WW/2](#) [C-PS2WW/3](#) [73220861](#) [CV0002](#) [CV0005](#) [CV0006](#) [CV0016](#) [CV0018](#) [74546-0402](#) [74546-1601](#) [74546-1603](#) [AU0002E](#)