

RP600C

HIGH PERFORMANCE DC POWER LINE FILTERS WITH CIRCUIT BREAKER

FEATURES

- » Rated currents include **15A, 30A, 60A, 80A, 100A, and 125A**
- » Dual Stage Line Filter
- » Available with **W** (wires), **S** (studs) and **C** (connectors) option
- » Agency Approved to UL1283 / 60929, CSA C22.2, EN 60939
- » Y-cap value can be adjusted to fit specification

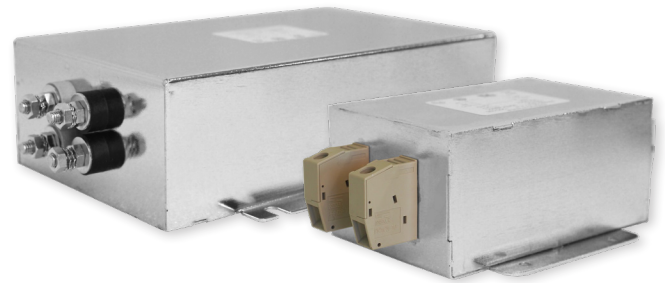

ELECTRICAL SCHEMATIC

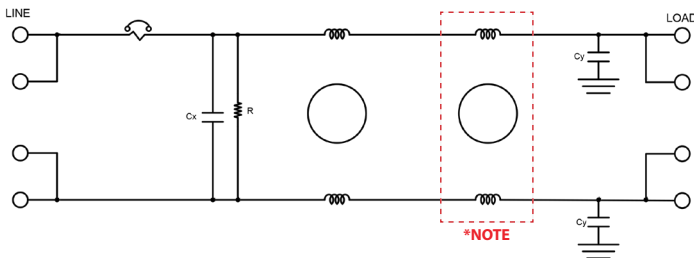

***NOTE**

SPECIFICATIONS

MAX. OPERATING VOLTAGE	100VDC +10%
AMBIENT TEMPERATURE	-25 TO 55°C
CLIMATIC CATEGORY	25/100/21
TERMINALS (-T)	WIRE LEADS
	STUDS 15-60A (M5)
	80-125A (M6)
	CONNECTORS

***NOTE** **INDUCTOR REMOVED FOR 100 A AND 125 A**

TYP. WEIGHT, LBS (KG) 1.3 - 7.7 (0.6 - 3.5)

HIPOT RATINGS

LINE TO GROUND 2700 VDC

TYPICAL APPLICATIONS

- ✓ Telecom systems
- ✓ Rack mounted
- ✓ Enclosures
- ✓ MIL-Aero
- ✓ Mobile System

HOW TO ORDER

RP600C-X-Y-Z-B

- B= B:BULKHEAD/F:FLANGE MOUNT
- Z= TERMINAL (-T)
- Y= Y-CAP, NF
- X= RATED CURRENT
- RP600C = FILTER SERIES

NOTE: USE ANY COMBINATION OF -X (AMPS) WITH ANY -Y RATINGS

E.G. **RP600-30-100-S-B** (6AMPS WITH 2.2 NF YCAP)

For **X, Y, Z** and **B** options see product specification table.

RP600C

HIGH PERFORMANCE DC POWER LINE FILTERS WITH CIRCUIT BREAKER

MODEL NO.	RATED CURRENT, A @ 40° C	Y-CAP, nF	TERMINAL OPTIONS			MOUNTING OPTIONS		MAX. DIMENSIONS" (MM)		
			(W) INPUT/ OUTPUT	(S) INPUT/ OUTPUT	(C) INPUT/ OUTPUT	BULKHEAD	FLANGE	WIDTH	(LENGTH)	HEIGHT
RP600C-15-4.7-C-B	15	4.7			✓	✓		5.06"(129)	7.99"(203)	1.48"(38)
RP600C-15-4.7-C-F	15	4.7			✓		✓	6.26"(159)	7.99"(203)	1.48"(38)
RP600C-15-4.7-S-B	15	4.7		✓		✓		5.06"(129)	7.22"(183)	1.48"(38)
RP600C-15-4.7-S-F	15	4.7		✓			✓	6.26"(159)	7.40"(188)	1.48"(38)
RP600C-15-4.7-W-B	15	4.7	✓			✓		*	*	*
RP600C-15-4.7-W-F	15	4.7	✓				✓	*	*	*
RP600C-15-10-C-B	15	10			✓	✓		5.06"(129)	7.99"(203)	1.48"(38)
RP600C-15-10-C-F	15	10			✓		✓	6.26"(159)	7.99"(203)	1.48"(38)
RP600C-15-10-S-B	15	10		✓		✓		5.06"(129)	7.22"(183)	1.48"(38)
RP600C-15-10-S-F	15	10		✓			✓	6.26"(159)	7.40"(188)	1.48"(38)
RP600C-15-10-W-B	15	10	✓			✓		*	*	*
RP600C-15-10-W-F	15	10	✓				✓	*	*	*
RP600C-15-22-C-B	15	22			✓	✓		5.06"(129)	7.99"(203)	1.48"(38)
RP600C-15-22-C-F	15	22			✓		✓	6.26"(159)	7.99"(203)	1.48"(38)
RP600C-15-22-S-B	15	22		✓		✓		5.06"(129)	7.22"(183)	1.48"(38)
RP600C-15-22-S-F	15	22		✓			✓	6.26"(159)	7.40"(188)	1.48"(38)
RP600C-15-22-W-B	15	22	✓			✓		*	*	*
RP600C-15-22-W-F	15	22	✓				✓	*	*	*
RP600C-15-100-C-B	15	100			✓	✓		5.06"(129)	7.99"(203)	1.48"(38)
RP600C-15-100-C-F	15	100			✓		✓	6.26"(159)	7.99"(203)	1.48"(38)
RP600C-15-100-S-B	15	100		✓		✓		5.06"(129)	7.22"(183)	1.48"(38)
RP600C-15-100-S-F	15	100		✓			✓	6.26"(159)	7.40"(188)	1.48"(38)
RP600C-15-100-W-B	15	100	✓			✓		*	*	*
RP600C-15-100-W-F	15	100	✓				✓	*	*	*
RP600C-30-4.7-C-B	30	4.7			✓	✓		*	*	*
RP600C-30-4.7-C-F	30	4.7			✓		✓	6.26"(159)	8.99"(228)	1.48"(38)
RP600C-30-4.7-S-B	30	4.7		✓		✓		5.06"(129)	8.22"(209)	1.48"(38)
RP600C-30-4.7-S-F	30	4.7		✓			✓	6.20"(158)	8.87"(225)	1.48"(38)
RP600C-30-4.7-W-B	30	4.7	✓			✓		*	*	*
RP600C-30-4.7-W-F	30	4.7	✓				✓	*	*	*
RP600C-30-10-C-B	30	10			✓	✓		*	*	*
RP600C-30-10-C-F	30	10			✓		✓	6.26"(159)	8.99"(228)	1.48"(38)
RP600C-30-10-S-B	30	10		✓		✓		5.06"(129)	8.22"(209)	1.48"(38)
RP600C-30-10-S-F	30	10		✓			✓	6.20"(158)	8.87"(225)	1.48"(38)

ADDITIONAL MODEL NO. >>

RP600C

HIGH PERFORMANCE **DC** POWER LINE FILTERS WITH CIRCUIT BREAKER

MODEL NO.	RATED CURRENT, A @ 40° C	Y-CAP, nF	TERMINAL OPTIONS			MOUNTING OPTIONS		MAX. DIMENSIONS" (MM)		
			(W) INPUT/ OUTPUT	(S) INPUT/ OUTPUT	(C) INPUT/ OUTPUT	BULKHEAD	FLANGE	WIDTH	(LENGTH)	HEIGHT
RP600C-30-10-W-B	30	10	✓			✓		*	*	*
RP600C-30-10-W-F	30	10	✓				✓	*	*	*
RP600C-30-22-C-B	30	22			✓	✓		*	*	*
RP600C-30-22-C-F	30	22			✓		✓	6.26"(159)	8.99"(228)	1.48"(38)
RP600C-30-22-S-B	30	22		✓		✓		5.06"(129)	8.22"(209)	1.48"(38)
RP600C-30-22-S-F	30	22		✓			✓	6.20"(158)	8.87"(225)	1.48"(38)
RP600C-30-22-W-B	30	22	✓			✓		*	*	*
RP600C-30-22-W-F	30	22	✓				✓	*	*	*
RP600C-30-100-C-B	30	100			✓	✓		*	*	*
RP600C-30-100-C-F	30	100			✓		✓	6.26"(159)	8.99"(228)	1.48"(38)
RP600C-30-100-S-B	30	100		✓		✓		5.06"(129)	8.22"(209)	1.48"(38)
RP600C-30-100-S-F	30	100		✓			✓	6.20"(158)	8.87"(225)	1.48"(38)
RP600C-30-100-W-B	30	100	✓			✓		*	*	*
RP600C-30-100-W-F	30	100	✓				✓	*	*	*
RP600C-60-4.7-C-B	60	4.7			✓	✓		*	*	*
RP600C-60-4.7-C-F	60	4.7			✓		✓	*	*	*
RP600C-60-4.7-S-B	60	4.7		✓		✓		5.06"(129)	10.69"(272)	1.48"(38)
RP600C-60-4.7-S-F	60	4.7		✓			✓	6.26"(159)	10.87"(276)	1.48"(38)
RP600C-60-4.7-W-B	60	4.7	✓			✓		*	*	*
RP600C-60-4.7-W-F	60	4.7	✓				✓	*	*	*
RP600C-60-10-C-B	60	10			✓	✓		*	*	*
RP600C-60-10-C-F	60	10			✓		✓	*	*	*
RP600C-60-10-S-B	60	10		✓		✓		5.06"(129)	10.69"(272)	1.48"(38)
RP600C-60-10-S-F	60	10		✓			✓	6.26"(159)	10.87"(276)	1.48"(38)
RP600C-60-10-W-B	60	10	✓			✓		*	*	*
RP600C-60-10-W-F	60	10	✓				✓	*	*	*
RP600C-60-22-C-B	60	22			✓	✓		*	*	*
RP600C-60-22-C-F	60	22			✓		✓	*	*	*
RP600C-60-22-S-B	60	22		✓		✓		5.06"(129)	10.69"(272)	1.48"(38)
RP600C-60-22-S-F	60	22		✓			✓	6.26"(159)	10.87"(276)	1.48"(38)
RP600C-60-22-W-B	60	22	✓			✓		*	*	*
RP600C-60-22-W-F	60	22	✓				✓	*	*	*
RP600C-60-100-C-B	60	100			✓	✓		*	*	*
RP600C-60-100-C-F	60	100			✓		✓	*	*	*

ADDITIONAL MODEL NO. >>

RP600C

HIGH PERFORMANCE **DC** POWER LINE FILTERS WITH CIRCUIT BREAKER

MODEL NO.	RATED CURRENT, A @ 40° C	Y-CAP, nF	TERMINAL OPTIONS			MOUNTING OPTIONS		MAX. DIMENSIONS" (MM)		
			(W) INPUT/ OUTPUT	(S) INPUT/ OUTPUT	(C) INPUT/ OUTPUT	BULKHEAD	FLANGE	WIDTH	(LENGTH)	HEIGHT
RP600C-60-100-S-B	60	100		✓		✓		5.06"(129)	10.69"(272)	1.48"(38)
RP600C-60-100-S-F	60	100		✓			✓	6.26"(159)	10.87"(276)	1.48"(38)
RP600C-60-100-W-B	60	100	✓			✓		*	*	*
RP600C-60-100-W-F	60	100	✓				✓	*	*	*
RP600C-80-4.7-C-B	80	4.7			✓	✓		*	*	*
RP600C-80-4.7-C-F	80	4.7			✓		✓	*	*	*
RP600C-80-4.7-S-B	80	4.7		✓		✓		5.06"(129)	10.69"(272)	1.48"(38)
RP600C-80-4.7-S-F	80	4.7		✓			✓	6.26"(159)	10.87"(276)	1.48"(38)
RP600C-80-4.7-W-B	80	4.7	✓			✓		*	*	*
RP600C-80-4.7-W-F	80	4.7	✓				✓	*	*	*
RP600C-80-10-C-B	80	10			✓	✓		*	*	*
RP600C-80-10-C-F	80	10			✓		✓	*	*	*
RP600C-80-10-S-B	80	10		✓		✓		5.06"(129)	10.69"(272)	1.48"(38)
RP600C-80-10-S-F	80	10		✓			✓	6.26"(159)	10.87"(276)	1.48"(38)
RP600C-80-10-W-B	80	10	✓			✓		*	*	*
RP600C-80-10-W-F	80	10	✓				✓	*	*	*
RP600C-80-22-C-B	80	22			✓	✓		*	*	*
RP600C-80-22-C-F	80	22			✓		✓	*	*	*
RP600C-80-22-S-B	80	22		✓		✓		5.06"(129)	10.69"(272)	1.48"(38)
RP600C-80-22-S-F	80	22		✓			✓	6.26"(159)	10.87"(276)	1.48"(38)
RP600C-80-22-W-B	80	22	✓			✓		*	*	*
RP600C-80-22-W-F	80	22	✓				✓	*	*	*
RP600C-80-100-C-B	80	100			✓	✓		*	*	*
RP600C-80-100-C-F	80	100			✓		✓	*	*	*
RP600C-80-100-S-B	80	100		✓		✓		5.06"(129)	10.69"(272)	1.48"(38)
RP600C-80-100-S-F	80	100		✓			✓	6.26"(159)	10.87"(276)	1.48"(38)
RP600C-80-100-W-B	80	100	✓			✓		*	*	*
RP600C-80-100-W-F	80	100	✓				✓	*	*	*
RP600C-100-4.7-C-B	100	4.7			✓	✓		6.06"(154)	13.09"(333)	1.78"(45)
RP600C-100-4.7-C-F	100	4.7			✓		✓	7.26"(184)	13.09"(333)	1.78"(45)
RP600C-100-4.7-S-B	100	4.7		✓		✓		6.06"(154)	12.26"(311)	1.78"(45)
RP600C-100-4.7-S-F	100	4.7		✓			✓	7.34"(187)	12.26"(311)	1.78"(45)
RP600C-100-4.7-W-B	100	4.7	✓			✓		*	*	*
RP600C-100-4.7-W-F	100	4.7	✓				✓	*	*	*

ADDITIONAL MODEL NO. >>

RP600C

HIGH PERFORMANCE DC POWER LINE FILTERS WITH CIRCUIT BREAKER

MODEL NO.	RATED CURRENT, A @ 40° C	Y-CAP, nF	TERMINAL OPTIONS			MOUNTING OPTIONS		MAX. DIMENSIONS" (MM)			
			(W) INPUT/ OUTPUT	(S) INPUT/ OUTPUT	(C) INPUT/ OUTPUT	BULKHEAD	FLANGE	WIDTH	(LENGTH)	HEIGHT	
RP600C-100-10-C-B	100	10			✓	✓			6.06"(154)	13.09"(333)	1.78"(45)
RP600C-100-10-C-F	100	10			✓		✓		7.26"(184)	13.09"(333)	1.78"(45)
RP600C-100-10-S-B	100	10		✓		✓			6.06"(154)	12.26"(311)	1.78"(45)
RP600C-100-10-S-F	100	10		✓			✓		7.34"(187)	12.26"(311)	1.78"(45)
RP600C-100-10-W-B	100	10	✓			✓			*	*	*
RP600C-100-10-W-F	100	10	✓				✓		*	*	*
RP600C-100-22-C-B	100	22			✓	✓			6.06"(154)	13.09"(333)	1.78"(45)
RP600C-100-22-C-F	100	22			✓		✓		7.26"(184)	13.09"(333)	1.78"(45)
RP600C-100-22-S-B	100	22		✓		✓			6.06"(154)	12.26"(311)	1.78"(45)
RP600C-100-22-S-F	100	22		✓			✓		7.34"(187)	12.26"(311)	1.78"(45)
RP600C-100-22-W-B	100	22	✓			✓			*	*	*
RP600C-100-22-W-F	100	22	✓				✓		*	*	*
RP600C-100-100-C-B	100	100			✓	✓			6.06"(154)	13.09"(333)	1.78"(45)
RP600C-100-100-C-F	100	100			✓		✓		7.26"(184)	13.09"(333)	1.78"(45)
RP600C-100-100-S-B	100	100		✓		✓			6.06"(154)	12.26"(311)	1.78"(45)
RP600C-100-100-S-F	100	100		✓			✓		7.34"(187)	12.26"(311)	1.78"(45)
RP600C-100-100-W-B	100	100	✓			✓			*	*	*
RP600C-100-100-W-F	100	100	✓				✓		*	*	*
RP600C-125-4.7-C-B	125	4.7			✓	✓			6.06"(154)	13.09"(333)	1.78"(45)
RP600C-125-4.7-C-F	125	4.7			✓		✓		7.26"(184)	13.09"(333)	1.78"(45)
RP600C-125-4.7-S-B	125	4.7		✓		✓			6.06"(154)	12.26"(311)	1.78"(45)
RP600C-125-4.7-S-F	125	4.7		✓			✓		7.34"(187)	12.26"(311)	1.78"(45)
RP600C-125-4.7-W-B	125	4.7	✓			✓			*	*	*
RP600C-125-4.7-W-F	125	4.7	✓				✓		*	*	*
RP600C-125-10-C-B	125	10			✓	✓			6.06"(154)	13.09"(333)	1.78"(45)
RP600C-125-10-C-F	125	10			✓		✓		7.26"(184)	13.09"(333)	1.78"(45)
RP600C-125-10-S-B	125	10		✓		✓			6.06"(154)	12.26"(311)	1.78"(45)
RP600C-125-10-S-F	125	10		✓			✓		7.34"(187)	12.26"(311)	1.78"(45)
RP600C-125-10-W-B	125	10	✓			✓			*	*	*
RP600C-125-10-W-F	125	10	✓				✓		*	*	*
RP600C-125-22-C-B	125	22			✓	✓			6.06"(154)	13.09"(333)	1.78"(45)
RP600C-125-22-C-F	125	22			✓		✓		7.26"(184)	13.09"(333)	1.78"(45)
RP600C-125-22-S-B	125	22		✓		✓			6.06"(154)	12.26"(311)	1.78"(45)
RP600C-125-22-S-F	125	22		✓			✓		7.34"(187)	12.26"(311)	1.78"(45)

ADDITIONAL MODEL NO. >>

RP600C

HIGH PERFORMANCE **DC** POWER LINE FILTERS WITH CIRCUIT BREAKER

MODEL NO.	RATED CURRENT, A @ 40° C	Y-CAP, nF	TERMINAL OPTIONS			MOUNTING OPTIONS		MAX. DIMENSIONS" (MM)		
			(W) INPUT/ OUTPUT	(S) INPUT/ OUTPUT	(C) INPUT/ OUTPUT	BULKHEAD	FLANGE	WIDTH	(LENGTH)	HEIGHT
RP600C-125-22-W-B	125	22	✓			✓		*	*	*
RP600C-125-22-W-F	125	22	✓				✓	*	*	*
RP600C-125-100-C-B	125	100			✓	✓		6.06"(154)	13.09"(333)	1.78"(45)
RP600C-125-100-C-F	125	100			✓		✓	7.26"(184)	13.09"(333)	1.78"(45)
RP600C-125-100-S-B	125	100		✓		✓		6.06"(154)	12.26"(311)	1.78"(45)
RP600C-125-100-S-F	125	100		✓			✓	7.34"(187)	12.26"(311)	1.78"(45)
RP600C-125-100-W-B	125	100	✓			✓		*	*	*
RP600C-125-100-W-F	125	100	✓				✓	*	*	*

*Contact factory for dimensions.

TYPICAL INSERTION LOSS, dB (50/50 Ohm)

Amps	Freq (MHz)	0.15	0.5	1.0	10	30
15	CM (dB)	22	42	50	50	40
	DM (dB)	30	32	38	40	35
30	CM (dB)	24	50	60	45	38
	DM (dB)	32	35	60	45	30
60	CM (dB)	18	40	40	45	35
	DM (dB)	40	42	35	42	35
80	CM (dB)	18	40	40	45	35
	DM (dB)	40	42	35	42	35
100	CM (dB)	20	40	40	35	25
	DM (dB)	40	42	30	45	35
125	CM (dB)	32	34	30	20	30
	DM (dB)	40	42	30	42	35

RP600C

HIGH PERFORMANCE DC POWER LINE FILTERS WITH CIRCUIT BREAKER

RP600C MECHANICAL OUTLINES (MM)

STUDS (B)

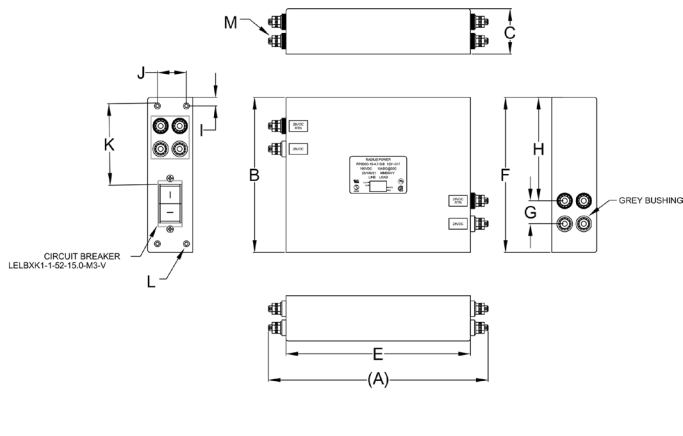

STUDS (F)

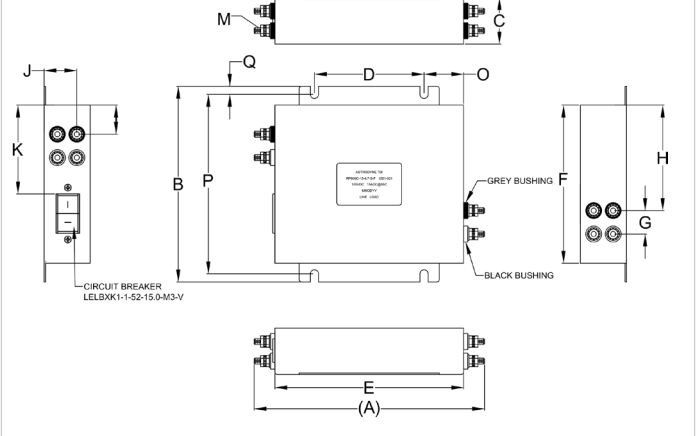

CONNECTORS (B) (15/30AMPS)

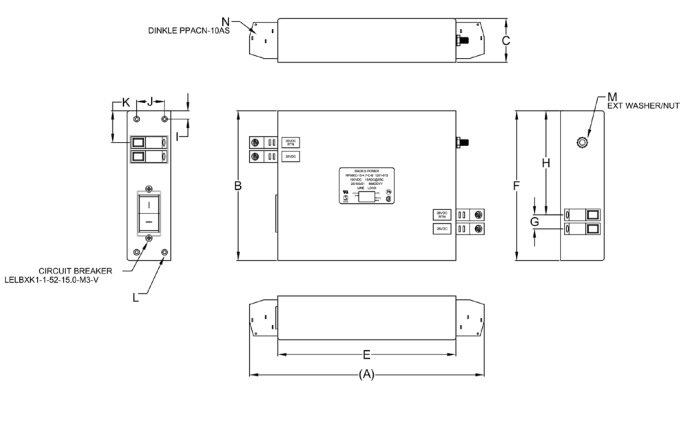

CONNECTORS (F) (15/30AMPS)

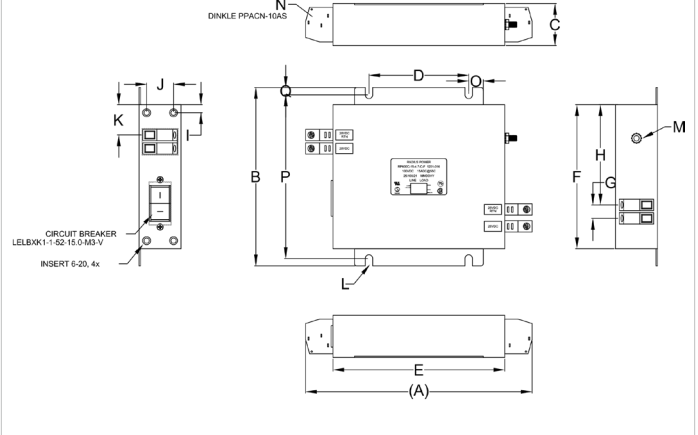

CONNECTORS (B) (60/80/100/125 AMPS)

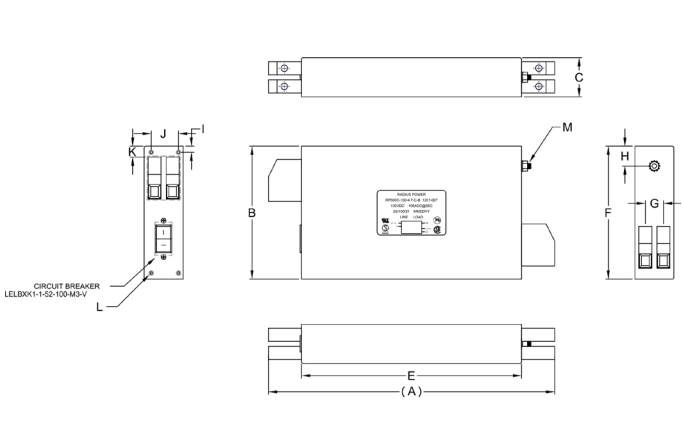

CONNECTORS (F) (60/80/100/125 AMPS)

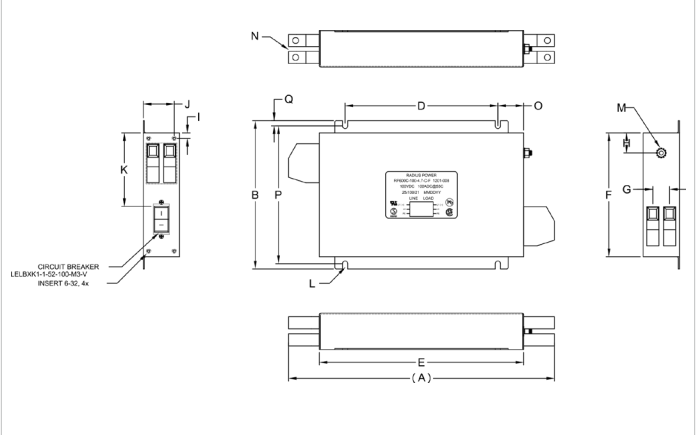

RP600

HIGH PERFORMANCE DC POWER LINE FILTER

SERIES	(A)	B	C	D	E	F	G	H	I	J	K	L	M	N	O	P	Q
STUDS (B) (15A)	7.22" (183)	5.06" (129)	1.48" (38)	N/A	6.06" (154)	5.06" (129)	0.75" (19)	3.38" (86)	0.28" (7)	0.96" (24)	2.66" (68)	INSERT 6-32, 4x	STUD M5, 8x	N/A	N/A	N/A	N/A
STUDS (F) (15A)	7.40" (188)	6.26" (159)	1.48" (38)	3.52" (89)	6.06" (154)	5.06" (129)	0.75" (19)	3.38" (86)	0.93" (24)	1.05" (27)	2.84" (72)	N/A	8x, M5 Stud	N/A	1.27" (32)	5.74" (146)	0.26" (7)
CONNECT. (B) (15A)	7.99" (203)	5.06" (129)	1.48" (38)	N/A	6.06" (154)	5.06" (129)	0.47" (12)	1.18" (30)	0.28" (7)	0.95" (24)	1.07" (27)	INSERT 6-20, 4x	STUD M5 GND	CONNECTOR, 4x	N/A	N/A	N/A
CONNECT. (F) (15A)	7.99" (203)	6.26" (159)	1.48" (38)	3.52" (89)	6.06" (154)	5.06" (129)	0.47" (12)	1.07" (27)	0.29" (7)	0.95" (24)	1.07" (27)	Ø 0.25"x0.38",4x (Ø 6.6x9.9, 4x)	STUD M5 GND	CONNECTOR, 4x	0.51" (13)	5.74" (146)	0.26" (7)
STUDS (B) (30A)	8.22" (209)	5.06" (129)	1.48" (38)	N/A	7.06" (179)	5.06" (129)	0.75" (19)	3.37" (86)	0.28" (7)	0.95" (24)	2.66" (68)	INSERT 6-20, 4x	STUD M5, 8x	N/A	N/A	N/A	N/A
STUDS (F) (30A)	8.87" (225)	6.20" (158)	1.48" (38)	4.52" (115)	7.06" (179)	5.00" (127)	0.75" (19)	3.32" (84)	0.93" (24)	1.05" (27)	2.78" (71)	Ø 0.38"x0.25",4x (Ø 9.9x6.6, 4x)	STUD M5, 8x	N/A	1.27" (32)	5.68" (144)	0.26" (7)
CONNECT. (F) (30A)	8.99" (228)	6.26" (159)	1.48" (38)	4.52" (115)	7.06" (179)	5.06" (129)	0.47" (12)	3.52" (89)	0.30" (8)	0.95" (24)	1.07" (27)	N/A	STUD M5 GND	CONNECTOR, 4x	0.51" (13)	5.74" (146)	0.26" (7)
STUDS (B) (60A)	10.69" (272)	5.06" (129)	1.48" (38)	N/A	9.06" (230)	5.06" (129)	0.75" (19)	3.37" (86)	0.28" (7)	0.95" (24)	2.65" (67)	INSERT 6-32, 4x	STUD M5, 8x	N/A	N/A	N/A	N/A
STUDS (F) (60A)	10.87" (276)	6.26" (159)	1.48" (38)	6.52" (166)	9.06" (230)	5.06" (129)	0.75" (19)	3.37" (86)	0.94" (24)	1.05" (27)	2.84" (72)	Ø 0.38"x0.25",4x (Ø 9.9x6.6, 4x)	STUD M5, 8x	N/A	1.27" (32)	5.74" (146)	0.26" (7)
STUDS (B) (100A)	12.26" (311)	6.06" (154)	1.78" (45)	N/A	10.06" (256)	6.06" (154)	1.00" (25)	4.00" (102)	0.28" (7)	1.27" (32)	3.41" (87)	N/A	STUD M6, 8x	N/A	N/A	N/A	N/A
STUDS (F) (100A)	12.26" (311)	7.34" (187)	1.78" (45)	4.69" (119)	10.06" (256)	6.06" (154)	1.00" (25)	4.00" (101)	0.27" (7)	1.25" (32)	3.42" (87)	INSERT 6-32, 4x	STUD M6, 8x	N/A	2.69" (68)	6.74" (171)	0.30" (8)
CONNECT. (B) (100A)	13.09" (333)	6.06" (154)	1.78" (45)	N/A	10.06" (256)	6.06" (154)	2.75" (70)	0.91" (23)	0.28" (7)	1.25" (32)	0.50" (13)	INSERT 6-32, 4x	STUD M6 GND	N/A	N/A	N/A	N/A
CONNECT. (F) (100A)	13.09" (333)	7.26" (184)	1.78" (45)	7.52" (191)	10.06" (256)	6.06" (154)	2.63" (67)	0.98" (25)	0.27" (7)	1.52" (39)	3.60" (91)	Ø 0.25"x0.38",4x (Ø 6.6x9.9, 4x)	STUD GND M6	CONNECTOR, 4x	1.27" (32)	6.74" (171)	0.26" (7)

TYPICAL TOLERANCE: +/-0.02" (0.50MM)

X-ON Electronics

Largest Supplier of Electrical and Electronic Components

Click to view similar products for [Power Line Filters](#) category:

Click to view products by [Astrodyne](#) manufacturer:

Other Similar products are found below :

[6609019-3](#) [6609026-5](#) [6609030-6](#) [6609973-2](#) [D30A](#) [7-1609090-5](#) [F2810](#) [F4456A](#) [F7382Z](#) [F7863Z](#) [FAHAV3100ZC000](#) [806276](#) [FN2020B-1-06](#) [FN2080B-10-06](#) [FN2410H-32-33](#) [FN2410H-80-34](#) [FP144](#) [FS4153-20-06](#) [FS4353-500-99](#) [12-MMB-030-11-D](#) [DB4-393](#) [15811T200](#) [20B1](#) [LC630](#) [2B1](#) [1609080-2](#) [1609993-8](#) [1-6609070-1](#) [F1100AA02](#) [F1150CC10](#) [F1500CA10](#) [F1500CA15](#) [F4041Z](#) [F7585E](#) [1B1](#) [FN2070A-16-06](#) [FN2090A-20-06](#) [FN2090B-12-06](#) [FN2090Z-1-06](#) [FN2410H-25-33](#) [FN2410H-60-34](#) [FN2410H-8-44](#) [FN2412H-8-44](#) [FN323B-6-01](#) [FN610R-3-06](#) [20EHQ7](#) [20EHZ7](#) [20K1](#) [30B6](#) [3K1](#)