

Features

- Ultra compact size (38.0 × 13.5 × 2.0mm)
- High RX sensitivity (-107dBm)
- Outperforming link budget (up to 127dB)
- Up to +20dBm output power
- Very low power consumption:
 - 30µA in sleep mode ⁽²⁾
 - 39.5mA in RX mode ⁽¹⁾
 - 183.5mA in TX mode ⁽¹⁾
- Ample memory resources (128KB of flash memory, 8KB RAM, 4KB EEPROM)
- Wide range of interfaces (both analog and digital)
 - Nine spare GPIO, two spare IRQ lines
 - Four ADC lines + one line for supply voltage control (up to nine lines with JTAG disabled)
 - UART with CTS/RTS control
 - USART
 - I²C
 - 1-wire
 - Up to 30 lines configurable as GPIO
- IEEE[®] 802.15.4 compliant transceiver
- 2.4GHz ISM band
- Extended range through additional PA and LNA
- Ultra-low power consumption combined with unprecedented range
- Rapid design-in with built-in U.FL connector (ATZB-A24-UFLB)
- Flexibility in using a different external antenna for every application
- Small physical footprint and low profile for optimum fit in even the smallest of devices
- Mesh networking capability
- Single source of support for HW and SW
- Worldwide license-free operation

- Notes:
1. Measured with LNA gain enabled / measured with TX output power of +20dBm; measured with MCU clock of 8MHz.
 2. Refer the Known Issues section.

Table of Contents

1. Introduction	3
1.1 Summary.....	3
1.2 Applications.....	3
2. Abbreviations and Acronyms	4
3. Related Documents	5
4. ZigBit Module Overview	6
4.1 Overview	6
5. Specifications	7
5.1 Electrical Characteristics.....	7
5.1.1 Absolute Maximum Ratings	7
5.1.2 Test Conditions	7
5.1.3 RF Characteristics	8
5.1.4 Atmel ATmega1281V Microcontroller Characteristics.....	8
5.1.5 Module Interfaces Characteristics.....	9
5.2 Physical/environmental Characteristics and Outline	9
5.3 Pin Configuration.....	10
5.4 Mounting Information	13
5.5 Soldering Profile.....	14
5.6 Product Design Considerations.....	14
5.7 Internal Schematics.....	16
6. Ordering Information	17
7. Agency Certification	18
7.1 United States (FCC).....	18
7.2 Using Limited Modular certified products	18
7.3 European Union (ETSI).....	18
8. Revision History	20
9. Known Issues.....	21

1. Introduction

1.1 Summary

ZigBit[®] Amp is an ultra-compact, extended range, low-power, and high-sensitivity 2.4GHz IEEE 802.15.4/ZigBee[®] OEM module from Atmel[®]. Based on the innovative mixed-signal hardware platform from Atmel, this module is enhanced by an LNA, PA integrated front end, and is designed for wireless sensing, monitoring, and control and data acquisition applications. ZigBit Amp modules eliminate the need for costly and time-consuming RF development, and shorten time-to-market for wireless applications with extended range requirements.

Two different versions of ZigBit 2.4GHz Amplified modules are available: the ATZB-A24-UFLB with built-in U.FL antenna connector, and the ATZB-A24-U0B with unbalanced 50Ω RF output.

1.2 Applications

The ZigBit module is compatible with robust IEEE 802.15.4/ZigBee stack that supports a self-healing, self-organizing mesh network, while optimizing network traffic and minimizing power consumption. Atmel offers two stack configurations; BitCloud and SerialNet. BitCloud is a ZigBee PRO certified software development platform supporting reliable, scalable, and secure wireless applications running on Atmel ZigBit modules. SerialNet allows programming of the module via a serial AT-command interface.

The applications include, but are not limited to:

- Building automation and monitoring
 - Lighting controls
 - Wireless smoke- and CO-detectors
 - Structural integrity monitoring
- HVAC monitoring and control
- Inventory management
- Environmental monitoring
- Security
- Water metering
- Industrial monitoring
 - Machinery condition and performance monitoring
 - Monitoring of plant system parameters such as temperature, pressure, flow, tank level, humidity, vibration, etc.
- Automated meter reading (AMR)

2. Abbreviations and Acronyms

ADC	Analog-to-Digital Converter
API	Application Programming Interface
DC	Direct Current
DTR	Data Terminal Ready
EEPROM	Electrically Erasable Programmable Read-Only Memory
ESD	Electrostatic Discharge
GPIO	General Purpose Input/Output
HAF	High Frequency
HVAC	Heating, Ventilating, and Air Conditioning
HW	Hardware
I2C	Inter-Integrated Circuit
IEEE	Institute of Electrical and Electronics Engineers
IRQ	Interrupt Request
ISM	Industrial, Scientific and Medical radio band
JTAG	Digital interface for debugging of embedded device, also known as IEEE 1149.1 standard interface
MAC	Medium Access Control layer
MCU	Microcontroller Unit. In this document it also means the processor, which is the core of a ZigBit module
NRE	Network layer
OEM	Original Equipment Manufacturer
OTA	Over-The-Air upgrade
PA	Power Amplifier
PCB	Printed Circuit Board
PER	Package Error Ratio
RAM	Random Access Memory
RF	Radio Frequency
RTS/CTS	Request to Send/ Clear to Send
RX	Receiver
SMA	Surface Mount Assembly
SPI	Serial Peripheral Interface
SW	Software
TTM	Time-To-Market
TX	Transmitter
UART	Universal Asynchronous Receiver/Transmitter
USART	Universal Synchronous/Asynchronous Receiver/Transmitter
USB	Universal Serial Bus
ZigBee, ZigBee PRO	Wireless networking standards targeted at low-power applications
802.15.4	The IEEE 802.15.4-2003 standard applicable to low-rate wireless Personal Area Network

3. Related Documents

- [1] ZigBit 2.4GHz Wireless Modules ATZB-24-B0/A2. Product datasheet. [Atmel doc8226.pdf](#)
- [2] ZigBit 700/800/900MHz Wireless Modules ATZB-900-B0. Product datasheet. [Atmel doc8227.pdf](#)
- [3] ZigBit 2.4 GHz Amplified Wireless Modules ATZB-A24-UFL/U0. [Atmel doc8228.pdf](#)
- [4] Atmel 8-bit AVR[®] Microcontroller with 64K/128K/256K Bytes In-System Programmable Flash. [Atmel doc2549.pdf](#)
- [5] Atmel Low-Power Transceiver for ZigBee Applications. AT86RF230 datasheet. [Atmel doc5131.pdf](#)
- [6] Ultra Small Surface Mount Coaxial Connectors - Low Profile 1.9mm or 2.4mm Mated Height. http://www.hirose.co.jp/cataloge_hp/e32119372.pdf
- [7] IEEE Std 802.15.4-2003 IEEE Standard for Information technology - Part 15.4 Wireless Medium Access Control (MAC) and Physical Layer (PHY) Specifications for Low-Rate Wireless Personal Area Networks (LR-WPANs)
- [8] ZigBee Specification. ZigBee Document 053474r17, October 19, 2007
- [9] BitCloud IEEE 802.15.4/ZigBee Software. AVR2050: BitCloud Developer Guide. [Atmel doc8199.pdf](#)

4. ZigBit Module Overview

4.1 Overview

The ZigBit Amp is an extended-range, low-power, high sensitivity IEEE 802.15.4/ZigBee OEM module. Based on a solid combination of the latest Atmel MCU Wireless hardware platform, power amplifier, and low-noise amplifier, the ZigBit Amp offers an unmatched combination of superior radio performance, ultra-low power consumption and exceptional ease of integration.

Figure 4-1. ATZB-A24-UFLB/U0B Block Diagram.

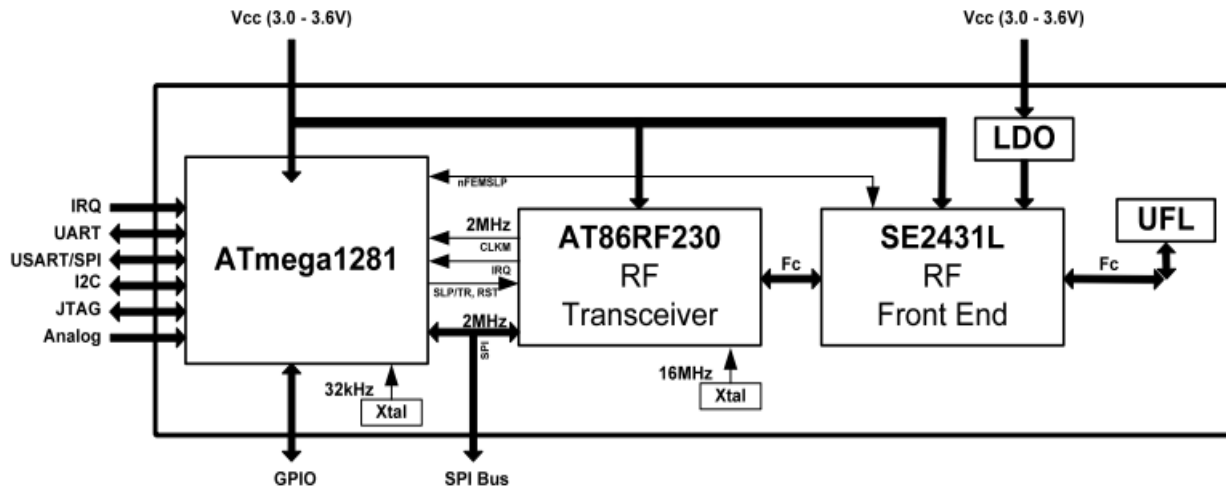

ZigBit Amp modules contain the Atmel ATmega1281V Microcontroller [4] and AT86RF230 RF Transceiver [5]. The module features 128KB flash memory and 8KB RAM.

The compact all-in-one chip integration of output Power Amplifier and input Low-Noise Amplifier, along with RF switches enables digital control of an external RF front-end to dramatically improve the ZigBit's range performance on signal transmission and increases its sensitivity. This ensures stable connectivity within a larger coverage area, without a significant increase in module size. The HF U.FL coaxial connector [6] used in the ATZB-A24-UFLB module enables the user to choose an appropriate external antenna for every type of application.

ZigBit Amp already contains a complete RF/MCU design with all the necessary passive components included. The module can be easily mounted on a simple 2-layer PCB with a minimum of required external connection. Compared to a custom RF/MCU solution, a module-based solution offers considerable savings in development time and NRE cost per unit during the design, prototyping, and mass production phases of product development.

All ZigBits are preloaded with a Bootloader when they are sold as Modules, either in Single units or T&R.

Depending on end-user design requirements, the ZigBit Amp can operate as a self-contained sensor node, where it would function as a single MCU, or it can be paired with a host processor driving the module over a serial interface. In the former case, a user application may be used with the BitCloud software allowing customization of embedded applications through BitCloud's C API.

In the latter case, the host processor controls data transmission and manages module peripherals via an extensive set of SerialNet AT commands. Thus, no firmware customization is required for a successful module design-in. Additionally, third-party sensors can be connected directly to the module, thus expanding the existing set of peripheral interfaces.

5. Specifications

5.1 Electrical Characteristics

5.1.1 Absolute Maximum Ratings

Table 5-1. Absolute Maximum Ratings ⁽¹⁾⁽²⁾.

Parameter	Minimum	Maximum
Voltage on any pin with respect to ground	-0.5V	V _{CC} + 0.5V
DC current per I/O pin		40mA
DC current DVCC and DGND pins		300mA
Input RF level		+5dBm

- Notes:
1. Absolute Maximum Ratings are the values beyond which damage to the device may occur. Under no circumstances must the absolute maximum ratings given in [Table 5-1](#) be violated. Stresses beyond those listed under "Absolute Maximum Ratings" may cause permanent damage to the device. This is a stress rating only. Functional operation of the device at these or other conditions, beyond those indicated in the operational sections of this specification, is not implied. Exposure to absolute maximum rating conditions for extended periods may affect device reliability.
 2. **Attention!** The ZigBit Amp is an ESD-sensitive device. Precaution should be taken when handling the device in order to prevent permanent damage.

5.1.2 Test Conditions

Table 5-2. Test Conditions (unless otherwise stated), F = 2.45GHz, V_{CC} = 3V, T_{amb} = 25°C.

Parameter	Range	Unit
Supply voltage, V _{CC}	3.0 to 3.6	V
Current consumption: RX mode ⁽¹⁾	39.5	mA
Current consumption: TX mode ⁽¹⁾	183.5	mA
Current consumption: Power-save mode ⁽¹⁾	30 ⁽²⁾	μA

- Note:
1. The parameters are measured under the following conditions:
 - a) RMS, BitCloud Software is running at 8MHz clock rate, DTR line management is turned off.
 - b) All interfaces are set to the default state (see [Table 5-9 Pin Descriptions](#).)
 - c) Output TX power (when measuring consumption in TX mode) is +20dBm.
 - d) JTAG is not connected.
 - e) LNA gain enabled when measuring consumption in RX mode.
 2. Refer the Known Issues section.

Current consumption actually depends on multiple factors, including but not limited to, the board design and materials, BitCloud settings, network activity, EEPROM read/write operations. It also depends on MCU load and/or peripherals used by an application.

5.1.3 RF Characteristics

Table 5-3. RF Characteristics.

Parameters	Condition	Range	Unit
Frequency band		2.4000 to 2.4835	GHz
Numbers of channels		16	
Channel spacing		5	MHz
Transmitter output power	Adjusted in 5 steps	+7 to +20	dBm
Receiver sensitivity	PER = 1%	-101	
On-air data rate		250	Kbps
TX output/ RX input nominal impedance	Unbalanced output	50	Ω
Range (open field, LoS, elevated)	With external 2.2dBi antenna	Up to 4000	m

Table 5-4. TX Power Settings – United States.

Register Value	Power Register Setting [dBm]	Output Power [dBm] (at antenna feed)
11	-5.2	+20
12	-7.2	+18
13	-9.2	+16
14	-12.2	+12
15	-17.2	+7

Table 5-5. TX Power Settings – European Union.

Register Value	Power Register Setting [dBm]	Output Power [dBm] (at antenna feed)
15	-17.2	+7

5.1.4 Atmel ATmega1281V Microcontroller Characteristics

Table 5-6. ATmega1281V Characteristics.

Parameters	Condition	Range	Unit
On-chip flash memory		128K	Bytes
On-chip RAM size		8K	Bytes
On-chip EEPROM size		4K	Bytes
Operation frequency		8	MHz

5.1.5 Module Interfaces Characteristics

Table 5-7. Module Interfaces Characteristics.

Parameters	Condition	Range	Unit
UART maximum baud rate		38.4	kbps
ADC resolution conversion time	In single conversion mode	10/200	Bits/μs
ADC input resistance		>1	MΩ
ADC reference voltage (VREF)		1.0 to V _{CC} - 3	V
ADC input voltage		0 – VREF	
I ² C maximum clock		400	kHz
GPIO output voltage (high/low)	-10/+5mA	2.3/0.5	V
Real-time oscillator frequency		32.768	kHz

5.2 Physical/environmental Characteristics and Outline

Table 5-8. Module Interfaces Characteristics.

Parameters	Value	Comments
Size	38.0 × 13.5 × 2.0mm	ATZB-A24-UFLB/U0B
Normal operating temperature range	-20°C to +70°C	Safe range
Extended operating temperature range	-40°C to +85°C operational ⁽¹⁾	Degraded range
Operating relative humidity range	No more than 80%	

Note: 1. Minor degradation of clock stability may occur.

Figure 5-1. Atmel ATZB-A24-UFLB/U0B Mechanical Drawing.

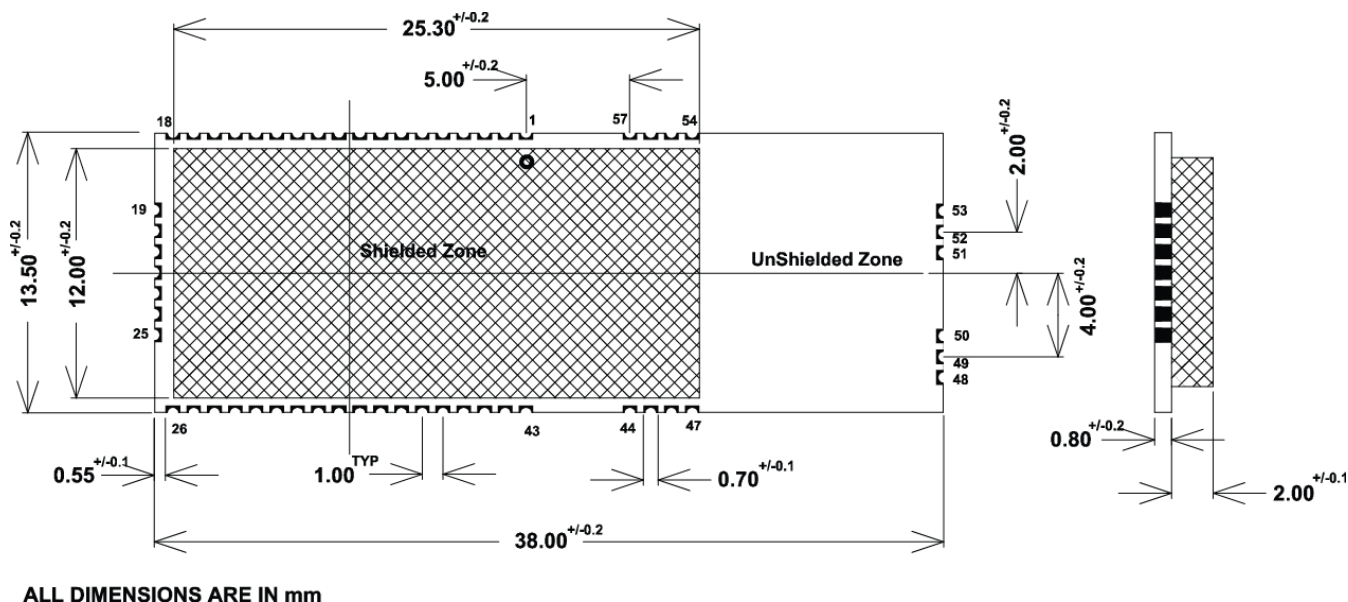

5.3 Pin Configuration

Figure 5-2. Atmel ATZB-A24-UFLB Pinout.

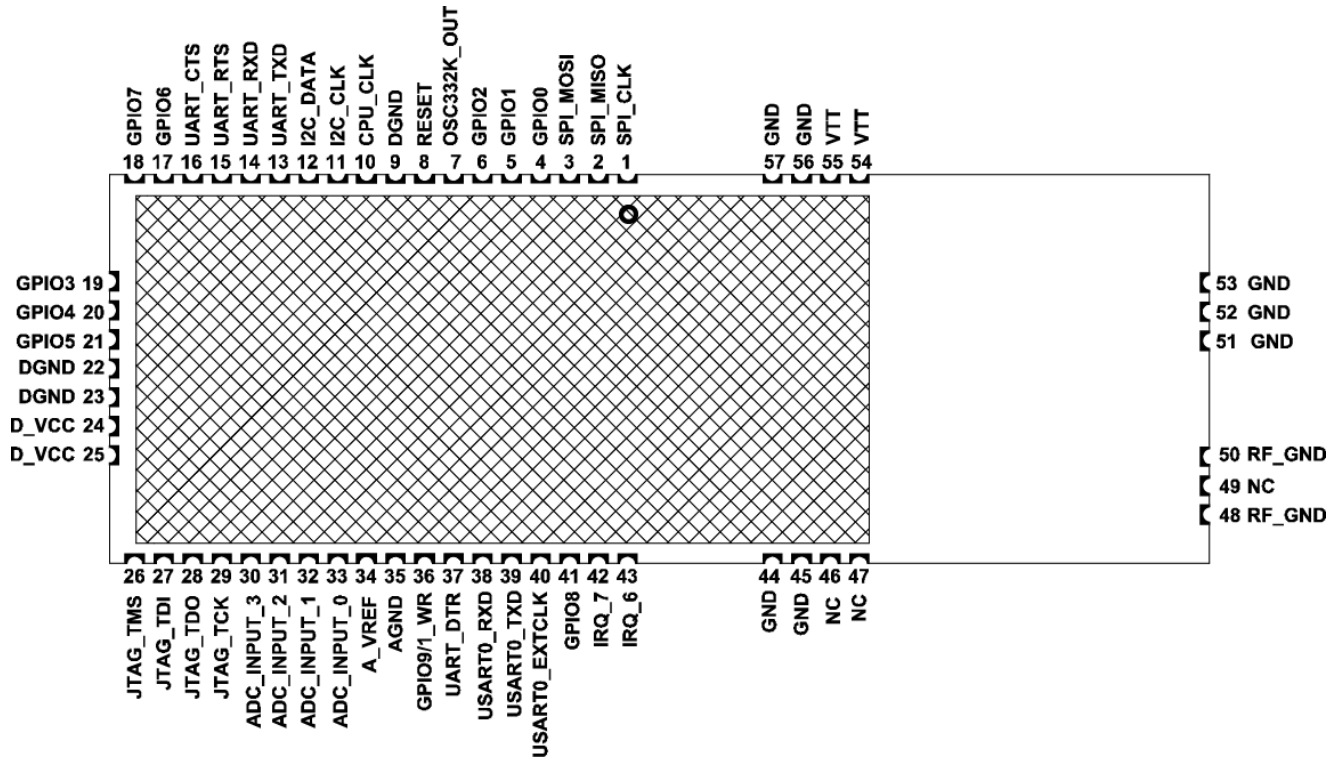

Figure 5-3. Atmel ATZB-A24-U0B Pinout.

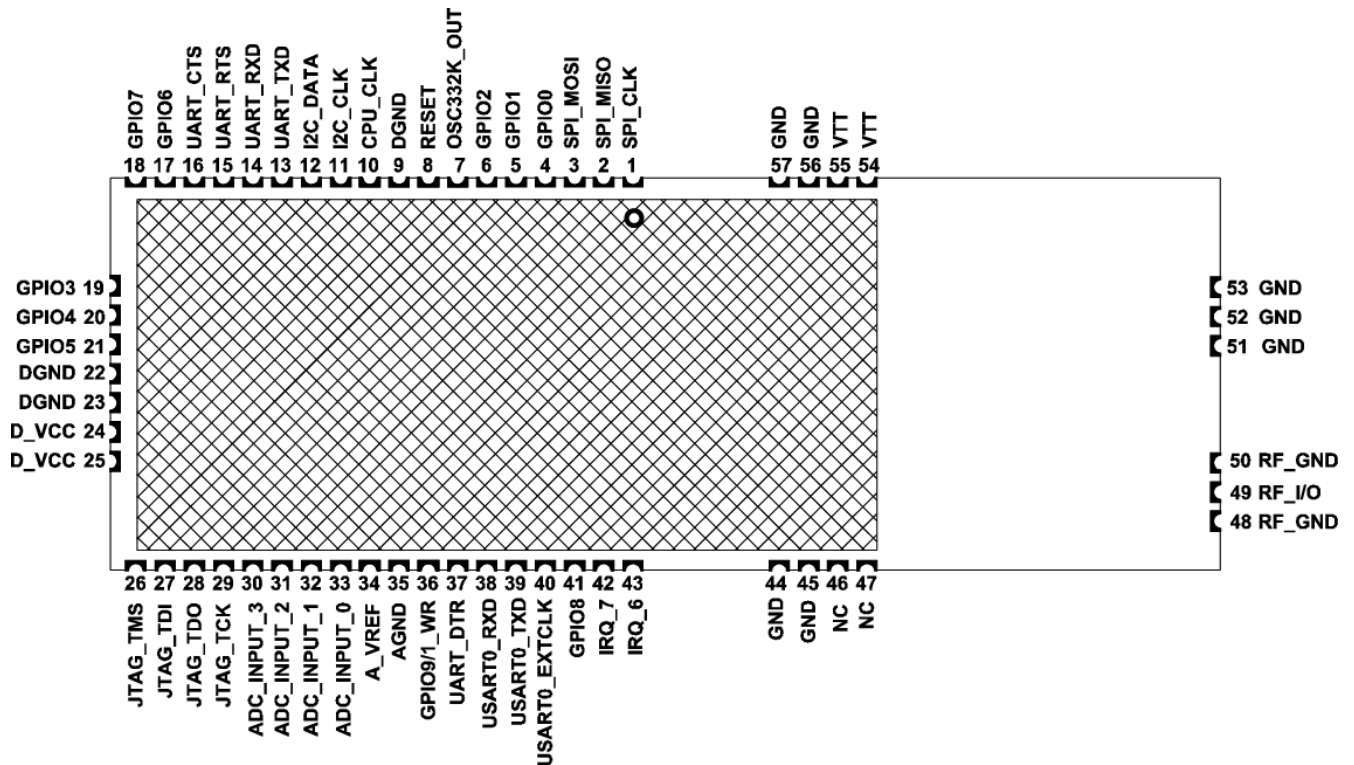

Table 5-9. Pin Descriptions.

Connector Pin	Pin Name	Description	I/O	Default State After Power On
1	SPI_CLK	Reserved for stack operation ⁽⁴⁾	O	
2	SPI_MISO	Reserved for stack operation ⁽⁴⁾	I/O	
3	SPI_MOSI	Reserved for stack operation ⁽⁴⁾	I/O	
4	GPIO0	General purpose digital input/output 0 ⁽²⁾⁽³⁾⁽⁴⁾⁽⁷⁾	I/O	tri-state
5	GPIO1	General purpose digital input/output 1 ⁽²⁾⁽³⁾⁽⁴⁾⁽⁷⁾	I/O	tri-state
6	GPIO2	General purpose digital input/output 2 ⁽²⁾⁽³⁾⁽⁴⁾⁽⁷⁾	I/O	tri-state
7	OSC32K_OUT	32.768kHz clock output ⁽⁴⁾⁽⁵⁾	O	
8	RESET	Reset input (active low) ⁽⁴⁾		
9, 22, 23	DGND	Digital ground		
10	CPU_CLK	RF clock output. When module is in active state, 8MHz signal is present on this line. While module is in the sleeping state, clock generation is also stopped ⁽⁴⁾ . This pin is a test point and not to be used to clock External devices	O	
11	I2C_CLK	I ² C Serial clock output ⁽²⁾⁽³⁾⁽⁴⁾⁽⁷⁾	O	tri-state
12	I2C_DATA	I ² C Serial data input/output ⁽²⁾⁽³⁾⁽⁴⁾⁽⁷⁾	I/O	tri-state
13	UART_TXD	UART receive input to ZigBit MCU ⁽¹⁾⁽²⁾⁽³⁾⁽⁴⁾⁽⁷⁾	I	tri-state
14	UART_RXD	UART transmit output from ZigBit MCU ⁽¹⁾⁽²⁾⁽³⁾⁽⁴⁾⁽⁷⁾	O	tri-state
15	UART_RTS	RTS input (request to send) for UART hardware flow control. Active low ⁽²⁾⁽³⁾⁽⁴⁾⁽⁷⁾	I	tri-state
16	UART_CTS	CTS output (clear to send) for UART hardware flow control. Active low ⁽²⁾⁽³⁾⁽⁴⁾⁽⁷⁾⁽⁸⁾	O	tri-state
17	GPIO6	General purpose digital input/output 6 ⁽²⁾⁽³⁾⁽⁴⁾⁽⁷⁾	I/O	tri-state
18	GPIO7	General purpose digital input/output 7 ⁽²⁾⁽³⁾⁽⁴⁾⁽⁷⁾	I/O	tri-state
19	GPIO3	General purpose digital input/output 3 ⁽²⁾⁽³⁾⁽⁴⁾⁽⁷⁾	I/O	tri-state
20	GPIO4	General purpose digital input/output 4 ⁽²⁾⁽³⁾⁽⁴⁾⁽⁷⁾	I/O	tri-state
21	GPIO5	General purpose digital input/output 5 ⁽²⁾⁽³⁾⁽⁴⁾⁽⁷⁾	I/O	tri-state
24, 25	D_VCC	Digital Supply Voltage (V _{CC}) ⁽⁹⁾		
26	JTAG_TMS	JTAG Test Mode Select ⁽²⁾⁽³⁾⁽⁴⁾⁽⁶⁾	I	
27	JTAG_TDI	JTAG Test Data Input ⁽²⁾⁽³⁾⁽⁴⁾⁽⁶⁾	I	
28	JTAG_TDO	JTAG Test Data Output ⁽²⁾⁽³⁾⁽⁴⁾⁽⁶⁾	O	
29	JTAG_TCK	JTAG Test Clock ⁽²⁾⁽³⁾⁽⁴⁾⁽⁶⁾	I	
30	ADC_INPUT_3	ADC Input Channel 3 ⁽²⁾⁽³⁾⁽⁷⁾	I	tri-state
31	ADC_INPUT_2	ADC Input Channel 2 ⁽²⁾⁽³⁾⁽⁷⁾	I	tri-state
32	ADC_INPUT_1	ADC Input Channel 1 ⁽²⁾⁽³⁾⁽⁷⁾	I	tri-state
33	BAT	ADC Input Channel 0, used for battery level measurement. This pin equals V _{CC} /3 ⁽²⁾⁽³⁾⁽⁷⁾	I	tri-state
34	A_VREF	Input/Output reference voltage for ADC	I/O	tri-state
35	AGND	Analog ground		
36	GPIO9/1_WR	General purpose digital input/output 9 / 1-wire interface ⁽²⁾⁽³⁾⁽⁴⁾⁽⁷⁾	I/O	

37	UART_DTR	DTR input (Data Terminal Ready) for UART. Active low ⁽²⁾⁽³⁾⁽⁴⁾⁽⁷⁾	I	tri-state
38	USART0_RXD	USART/SPI Receive pin ⁽²⁾⁽³⁾⁽⁴⁾⁽⁷⁾	I	tri-state
39	USART0_TXD	USART /SPI Transmit pin ⁽²⁾⁽³⁾⁽⁴⁾⁽⁷⁾	O	tri-state
40	USART0_EXTCLK	USART/SPI External Clock ⁽²⁾⁽³⁾⁽⁴⁾⁽⁷⁾⁽¹¹⁾	I/O	tri-state
41	GPIO8	General Purpose Digital Input/Output	I/O	tri-state
42	IRQ_7	Digital Input Interrupt request 7 ⁽²⁾⁽³⁾⁽⁴⁾⁽⁷⁾	I	tri-state
43	IRQ_6	Digital Input Interrupt request 6 ⁽²⁾⁽³⁾⁽⁴⁾⁽⁷⁾	I	tri-state
44, 45, 51, 52, 53, 56, 57	DGND	Digital ground		
46, 47	NC	Not connected		
48, 50	RF GND	RF analog ground ⁽²⁾⁽³⁾⁽⁴⁾⁽⁷⁾		
49	RFP_IO	RF Input/Output ⁽¹⁰⁾	I/O	
54, 55	VTT	Transmitter supply voltage ⁽⁹⁾		

- Notes:
1. The UART_TXD pin is intended for input (that is, its designation as "TXD" implies some complex system containing ZigBit as its RF terminal unit), while UART_RXD pin, vice versa, is for output.
 2. Most of pins can be configured for general purpose I/O or for some alternate functions as described in details in the Atmel ATmega1281V Datasheet [3].
 3. GPIO pins can be programmed either for output, or for input with/without pull-up resistors. Output pin drivers are strong enough to drive LED displays directly (refer to figures on pages 387-388, [3]).
 4. All digital pins are provided with protection diodes to D_VCC and DGND.
 5. It is strongly recommended to avoid assigning an alternate function for OSC32K_OUT pin because it is used by BitCloud.
 6. Normally, JTAG_TMS, JTAG_TDI, JTAG_TDO, JTAG_TCK pins are used for on-chip debugging and flash burning. They can be used for A/D conversion if JTAGEN fuse is disabled.
 7. The following pins can be configured with the BitCloud software to be general-purpose I/O lines: GPIO0, GPIO1, GPIO2, GPIO3, GPIO4, GPIO5, GPIO6, GPIO7, GPIO8, GPIO_1WR, I2C_CLK, I2C_DATA, UART_TXD, UART_RXD, UART_RTS, UART_CTS, ADC_INPUT_3, ADC_INPUT_2, ADC_INPUT_1, BAT, UART_DTR, USART0_RXD, USART0_TXD, USART0_EXTCLK, IRQ_7, IRQ_6. Additionally, four JTAG lines can be programmed with software as GPIO as well, but this requires changing the fuse bits and will disable JTAG debugging.
 8. With BitCloud, CTS pin can be configured to indicate sleep/active condition of the module thus providing mechanism for power management of the host processor. If this function is necessary, a connection of this pin to an external pull-down resistor is recommended to prevent the undesirable transients during the module reset process.
 9. Using ferrite bead and 1µF capacitor located closely to the power supply pin is recommended, as shown below:

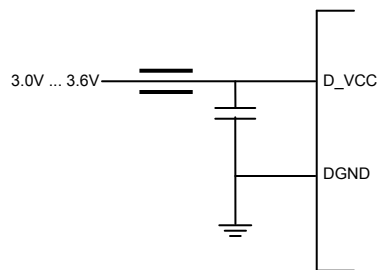
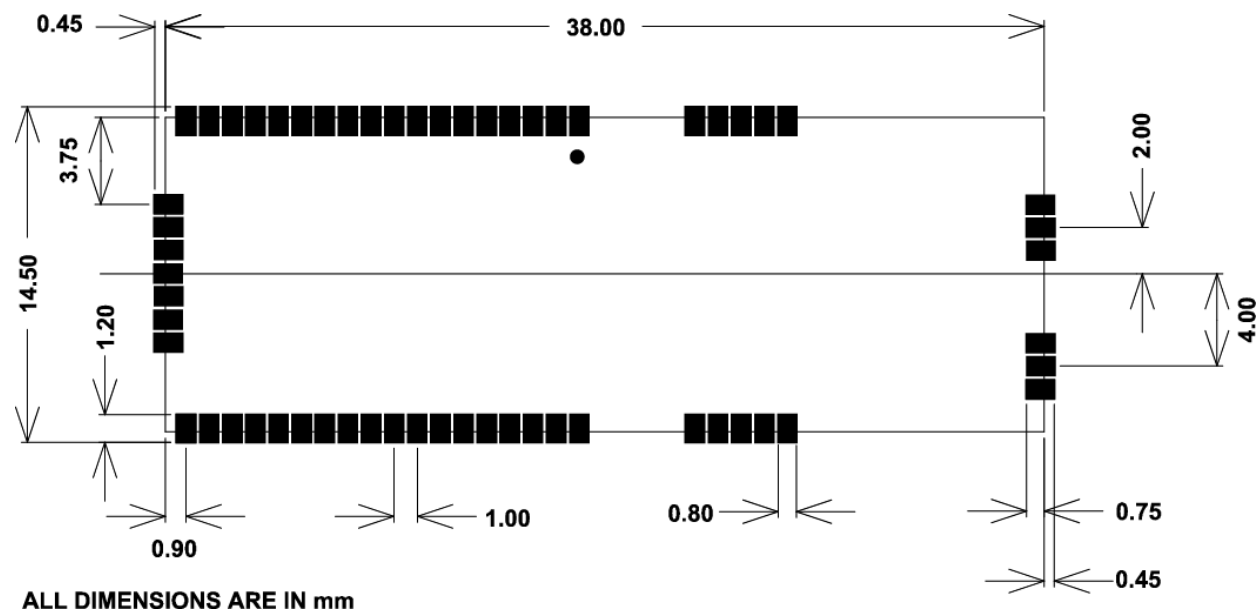

Figure 5-4. Atmel ATZB-A24-UFL/U0 PCB Recommended Layout, Top View.



5.5 Soldering Profile

The J-STD-020C-compliant soldering profile is recommended according to [Table 5-10](#).

Table 5-10. Soldering Profile ⁽¹⁾.

Profile Feature	Green Package
Average ramp-up rate (217°C to peak)	3°C/s max.
Preheat temperature 175°C ±25°C	180s max.
Temperature maintained above 217°C	60s to 150s
Time within 5°C of actual peak temperature	20s to 40s
Peak temperature range	260°C
Ramp-down rate	6°C/s max.
Time within 25°C to peak temperature	8 minutes

Note: 1. The package is backward compatible with PB/Sn soldering profile.

5.6 Product Design Considerations

Multiple factors affect proper antenna match, hence, affecting the antenna pattern. The particular factors are the board material and thickness, shields, the material used for enclosure, the board neighborhood, and other components adjacent to antenna.

General recommendations:

- Metal enclosure should not be used. Using low profile enclosure might also affect antenna tuning
- Placing high profile components next to antenna should be avoided
- Having holes/vias punched around the periphery of the board eliminates parasitic radiation from the board edges also distorting antenna pattern

- ZigBit Amp module should not be placed next to consumer electronics which might interfere with ZigBit Amp's RF band frequency

The board design should prevent propagation of microwave field inside the board material. Electromagnetic waves of high frequency may penetrate the board thus making the edges of the board radiate, which may distort the antenna pattern. To eliminate this effect, metalized and grounded holes/vias must be placed around the board's edges.

5.7 Internal Schematics

Figure 5-5. Internal Schematics.

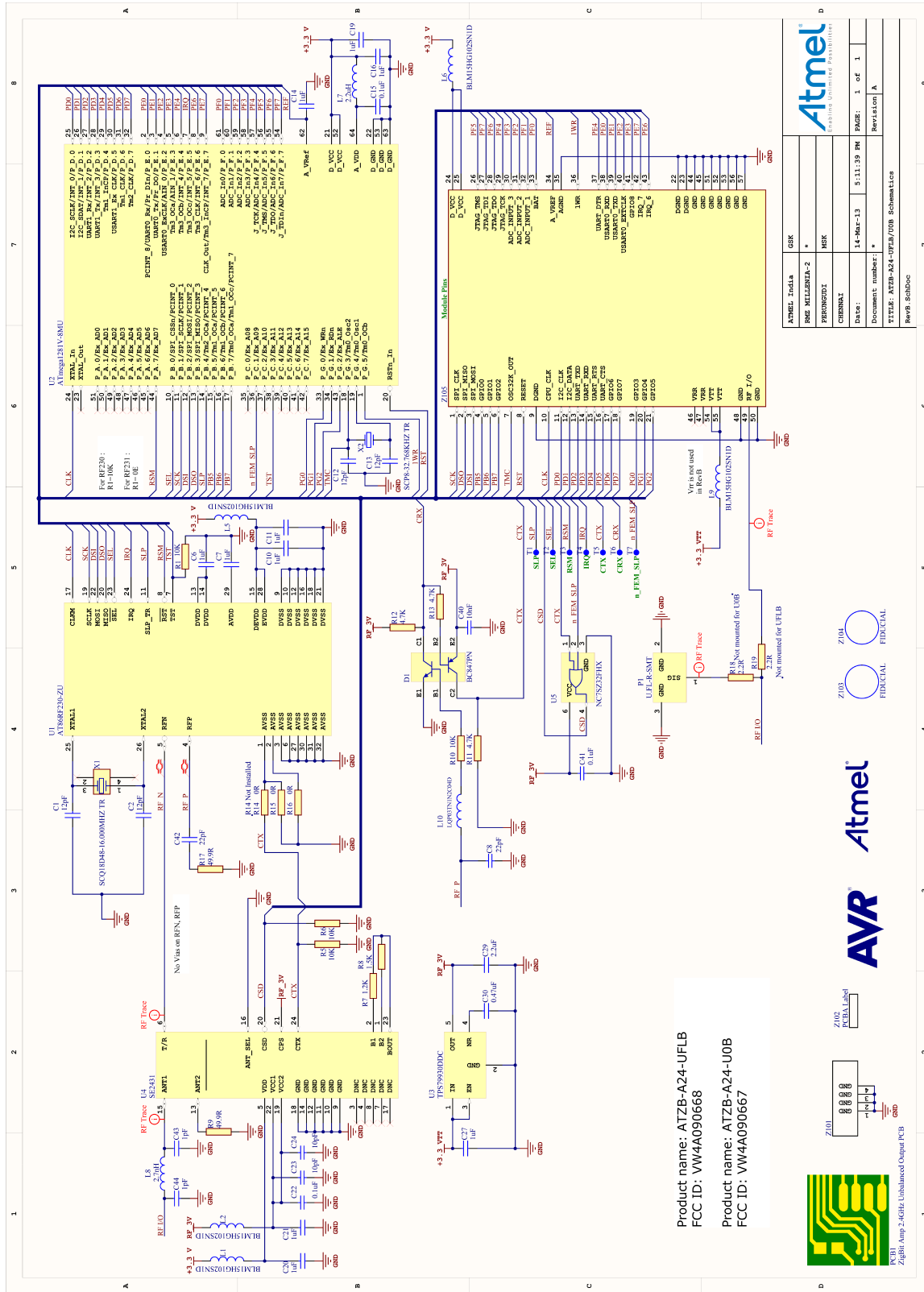

6. Ordering Information

Table 6-1. Ordering Information.

Part Number	Description
ATZB-A24-UFLBR	2.4GHz IEEE802.15.4/ZigBee power amplified OEM module with U.FL antenna connector - RevB, tape and reel
ATZB-A24-UFLB	2.4GHz IEEE802.15.4/ZigBee power amplified OEM module with U.FL antenna connector -RevB, single unit
ATZB-A24-U0BR	2.4GHz IEEE802.15.4/ZigBee power amplified OEM module with unbalanced RF output –RevB, tape and reel
ATZB-A24-U0B	2.4GHz IEEE802.15.4/ZigBee power amplified OEM module with unbalanced RF output -RevB, single unit

Note: Tape and reel quantity: 200.

7. Agency Certification

7.1 United States (FCC)

1. The ATZB-A24-UFLB is certified as Limited modular transmitter with FCC ID VW4A090668.
2. The ATZB-A24-U0B is certified as Limited modular transmitter with FCC ID VW4A090667.

IMPORTANT: The ATZB-A24-UFLB and ATZB-A24-U0B comply with Part 15 of the FCC Rules. Operation is subject to the following two conditions: (1) this device may not cause harmful interference, and (2) this device must accept any interference received, including interference that may cause undesired operation (FCC 15.19).

The internal / external antenna(s) used for this mobile transmitter must provide a separation distance of at least 20cm from all persons and must not be colocated or operating in conjunction with any other antenna or transmitter.

Installers must be provided with antenna installation instructions and transmitter operating conditions for satisfying RF exposure compliance. This device is approved as a mobile device with respect to RF exposure compliance, and may only be marketed to OEM installers. Use in portable exposure conditions (FCC 2.1093) requires separate equipment authorization.

IMPORTANT: Modifications not expressly approved by the company could void the user's authority to operate this equipment (FCC section 15.21).

IMPORTANT: This equipment has been tested and found to comply with the limits for a Class A digital device, pursuant to Part 15 of the FCC Rules. These limits are designed to provide reasonable protection against harmful interference when the equipment is operated in a commercial environment. This equipment generates, uses, and can radiate radio frequency energy and, if not installed and used in accordance with the instruction manual, may cause harmful interference to radio communications. Operation of this equipment in a residential area is likely to cause harmful interference in which case the user will be required to correct the interference at his own expense (FCC section 15.105).

7.2 Using Limited Modular certified products

The ATZB-A24-UFLB and ATZB-A24-U0B Zigbit Modules are certified under the Modular certification category of "Limited Modular transmitter". Any final end product created using these modules must undergo FCC compliance testing of the complete final product that includes these modules and receive a new FCC ID assignment for the final product carrying these modules. Successful certification of the final product lies solely with the type of design of the final product, excluding the pre- tested Zigbit module.

7.3 European Union (ETSI)

The ATZB-A24-UFLB, ATZB-A24-U0B Modules has been certified for use in European Union countries. If these modules are incorporated into a product, the manufacturer must ensure compliance of the final product to the European harmonized EMC and lowvoltage/safety standards. A Declaration of Conformity must be issued for each of these standards and kept on file as described in Annex II of the R&TTE Directive.

Furthermore, the manufacturer must maintain a copy of the modules' documentation and ensure the final product does not exceed the specified power ratings, antenna specifications, and/or installation requirements as specified in the user manual. If any of these specifications are exceeded in the final product, a submission must be made to a notified body for compliance testing to all required standards.

IMPORTANT: The 'CE' marking must be affixed to a visible location on the OEM product. The CE mark shall consist of the initials "CE" taking the following form:

The CE marking must have a height of at least 5mm except where this is not possible on account of the nature of the apparatus.

The CE marking must be affixed visibly, legibly, and indelibly.

More detailed information about CE marking requirements you can find at "DIRECTIVE 1999/5/EC OF THE EUROPEAN PARLIAMENT AND OF THE COUNCIL" on 9 March 1999 at section 12.

8. Revision History

Doc. Rev.	Date	Comments
42058C	05/2013	Several figures have been replaced
42058B	03/2013	Several corrections made
42058A	12/2012	Initial document release

9. Known Issues

Due to a design issue, The ATZB-A24-UFLB, ATZB-A24-U0B modules will consume about 160 μ A@3.0V in sleep mode.

**Atmel Corporation**

1600 Technology Drive
San Jose, CA 95110
USA

Tel: (+1)(408) 441-0311

Fax: (+1)(408) 487-2600

www.atmel.com

Atmel Asia Limited

Unit 01-5 & 16, 19F
BEA Tower, Millennium City 5
418 Kwun Tong Road
Kwun Tong, Kowloon

HONG KONG

Tel: (+852) 2245-6100

Fax: (+852) 2722-1369

Atmel Munich GmbH

Business Campus
Parking 4
D-85748 Garching b. Munich
GERMANY

Tel: (+49) 89-31970-0

Fax: (+49) 89-3194621

Atmel Japan G.K.

16F Shin-Osaki Kangyo Building
1-6-4 Osaki Shinagawa-ku
Tokyo 141-0032
JAPAN

Tel: (+81)(3) 6417-0300

Fax: (+81)(3) 6417-0370

© 2013 Atmel Corporation. All rights reserved. / Rev.: 42058C–WIRELESS–06/2013

Atmel®, Atmel logo and combinations thereof, AVR®, BitCloud®, Enabling Unlimited Possibilities®, ZigBit®, and others are registered trademarks or trademarks of Atmel Corporation or its subsidiaries. Other terms and product names may be trademarks of others.

Disclaimer: The information in this document is provided in connection with Atmel products. No license, express or implied, by estoppel or otherwise, to any intellectual property right is granted by this document or in connection with the sale of Atmel products. EXCEPT AS SET FORTH IN THE ATMEL TERMS AND CONDITIONS OF SALES LOCATED ON THE ATMEL WEBSITE, ATMEL ASSUMES NO LIABILITY WHATSOEVER AND DISCLAIMS ANY EXPRESS, IMPLIED OR STATUTORY WARRANTY RELATING TO ITS PRODUCTS INCLUDING, BUT NOT LIMITED TO, THE IMPLIED WARRANTY OF MERCHANTABILITY, FITNESS FOR A PARTICULAR PURPOSE, OR NON-INFRINGEMENT. IN NO EVENT SHALL ATMEL BE LIABLE FOR ANY DIRECT, INDIRECT, CONSEQUENTIAL, PUNITIVE, SPECIAL OR INCIDENTAL DAMAGES (INCLUDING, WITHOUT LIMITATION, DAMAGES FOR LOSS AND PROFITS, BUSINESS INTERRUPTION, OR LOSS OF INFORMATION) ARISING OUT OF THE USE OR INABILITY TO USE THIS DOCUMENT, EVEN IF ATMEL HAS BEEN ADVISED OF THE POSSIBILITY OF SUCH DAMAGES. Atmel makes no representations or warranties with respect to the accuracy or completeness of the contents of this document and reserves the right to make changes to specifications and products descriptions at any time without notice. Atmel does not make any commitment to update the information contained herein. Unless specifically provided otherwise, Atmel products are not suitable for, and shall not be used in, automotive applications. Atmel products are not intended, authorized, or warranted for use as components in applications intended to support or sustain life.

X-ON Electronics

Largest Supplier of Electrical and Electronic Components

Click to view similar products for [Zigbee / 802.15.4 Modules](#) category:

Click to view products by [Atmel](#) manufacturer:

Other Similar products are found below :

[GNS802](#) [20849-104](#) [ATSAMR21B18-MZ210PA](#) [X2E-Z1R-E1-W](#) [X2E-Z1R-W1-W](#) [XBP24BZ7WITB003J](#) [CC-MX-LB69-ZK](#) [CC-WMX-MB47-VM](#) [XBP24-ASI-080](#) [X2E-Z1R-E1-A](#) [ATZB-S1-256-3-0-C](#) [AX-SF10-MINI21-868-B1](#) [ATZB-RF-212B-0-CNR](#) [EM357-MOD-ANT-C](#) [AX-SF10-ANT21-868-B1](#) [14575176](#) [XBP24BZ7WITB003](#) [XM-C91-4P-U](#) [ZICM35XSPX-PF-1](#) [CC-MX-LB6B-ZM](#) [ATZB-S1-256-3-0-CR](#) [EM357-MOD-RF-C](#) [20849131](#) [ETRX357USB8M](#) [20848674](#) [CC-MX-LB58-ZM](#) [A2530E24CZ1GM](#) [ATZB-RF-233-1-C](#) [ATZB-X0-256-3-0-C](#) [ZXT24-IO-222R2](#) [20-101-0513](#) [XA-Z14-CS3PH-A](#) [XA-Z14-CS4PH-A](#) [XB24-ASI-001](#) [XB24CAPIS-001](#) [XB24CAPIT-001](#) [XB24CARIS-001](#) [XB24CASIT-001](#) [XB24CAUIS-001](#) [XB24CAUIT-001](#) [XB24CAWIT-001](#) [XB24CZ7PIS-004](#) [XB24CZ7PISB003](#) [XB24CZ7PIT-004](#) [XB24CZ7PITB003](#) [XB24CZ7RIS-004](#) [XB24CZ7RISB003](#) [XB24CZ7SIT-004](#) [XB24CZ7SITB003](#) [XB24CZ7UIS-004](#)