

ACAD GENERATED DRAWING. DON'T CHANGE BY HAND

PITCH 0.5mm FPC CONNECTOR SMT TYPE

REV.	DATE	MODIFICATION	APPROVER
B	10.12.15	版本升级	HYQ
C	10.12.17	触点结构优化	JACKSON

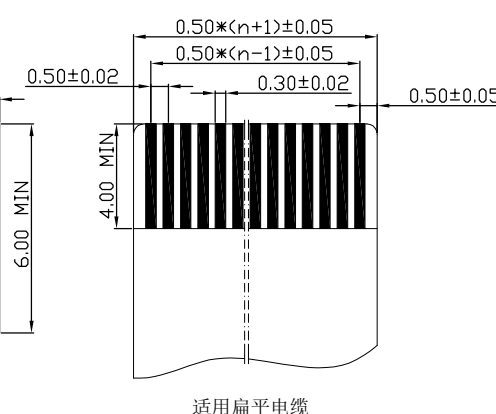
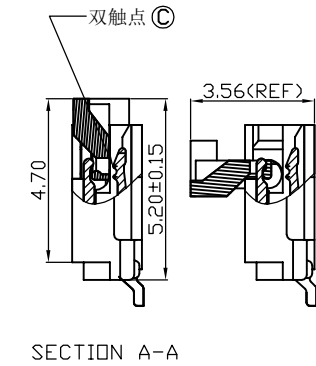
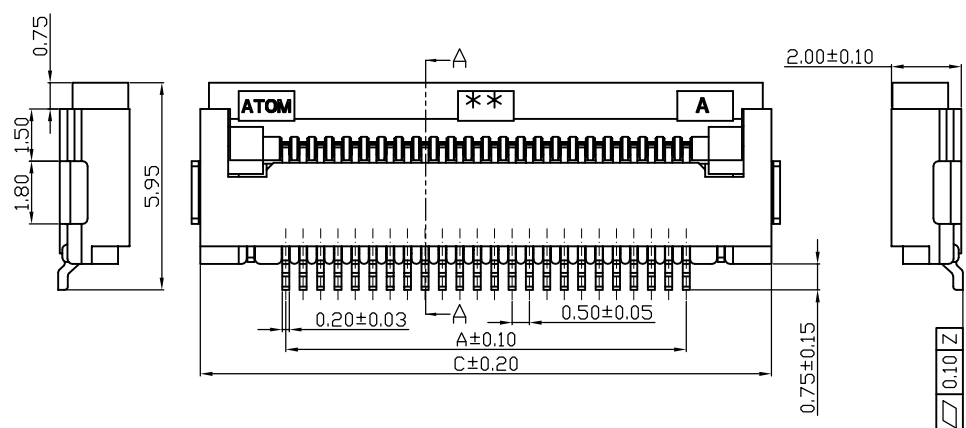
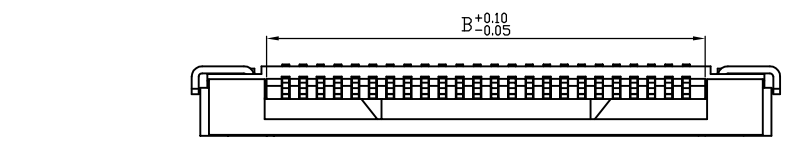

孔位	A	B	C	D
4	1.50	2.60	6.40	6.90
5	2.00	3.10	6.90	7.40
6	2.50	3.60	7.40	7.90
7	3.00	4.10	7.90	8.40
8	3.50	4.60	8.40	8.90
9	4.00	5.10	8.90	9.40
10	4.50	5.60	9.40	9.90
11	5.00	6.10	9.90	10.40
12	5.50	6.60	10.40	10.90
13	6.00	7.10	10.90	11.40
14	6.50	7.60	11.40	11.90
15	7.00	8.10	11.90	12.40
16	7.50	8.60	12.40	12.90
17	8.00	9.10	12.90	13.40
18	8.50	9.60	13.40	13.90
19	9.00	10.10	13.90	14.40
20	9.50	10.60	14.40	14.90
21	10.00	11.10	14.90	15.40
22	10.50	11.60	15.40	15.90
23	11.00	12.10	15.90	16.40
24	11.50	12.60	16.40	16.90
25	12.00	13.10	16.90	17.40
26	12.50	13.60	17.40	17.90
27	13.00	14.10	17.90	18.40
28	13.50	14.60	18.40	18.90
29	14.00	15.10	18.90	19.40
30	14.50	15.60	19.40	19.90
31	15.00	16.10	19.90	20.40
32	15.50	16.60	20.40	20.90
33	16.00	17.10	20.90	21.40
34	16.50	17.60	21.40	21.90
35	17.00	18.10	21.90	22.40
36	17.50	18.60	22.40	22.90
37	18.00	19.10	22.90	23.40
38	18.50	19.60	23.40	23.90
39	19.00	20.10	23.90	24.40
40	19.50	20.60	24.40	24.90
41	20.00	21.10	24.90	25.40
42	20.50	21.60	25.40	25.90
43	21.00	22.10	25.90	26.40
44	21.50	22.60	26.40	26.90
45	22.00	23.10	26.90	27.40
46	22.50	23.60	27.40	27.90
47	23.00	24.10	27.90	28.40
48	23.50	24.60	28.40	28.90
49	24.00	25.10	28.90	29.40
50	24.50	25.60	29.40	29.90
51	25.00	26.10	29.90	30.40
52	25.50	26.60	30.40	30.90
53	26.00	27.10	30.90	31.40
54	26.50	27.60	31.40	31.90
55	27.00	28.10	31.90	32.40
56	27.50	28.60	32.40	32.90
57	28.00	29.10	32.90	33.40
58	28.50	29.60	33.40	33.90
59	29.00	30.10	33.90	34.40
60	29.50	30.60	34.40	34.90

SPECIFICATION

- Material:**
 Housing: Thermoplastic, UL94V-0,color:Natural .
 Lock: Thermoplastic, UL94V-0,color:black.
 Contacts: Phosphor Bronze,
 Tin/Gold plated over nickel plated
 Solder tab: Phosphor Bronze
 Tin/Gold plated over nickel plated
- Electrical Characteristics:**
 Voltage rating: 50V(max).
 Current rating : 0.5A(max).
 Operating Temperature: -25°C~+85°C.
 Insulation resistance: 500M ohms min. at 500VDC
 Dielectric withstanding voltage: 250 VAC/1minute.
 Contact resistance: 20m ohms max.

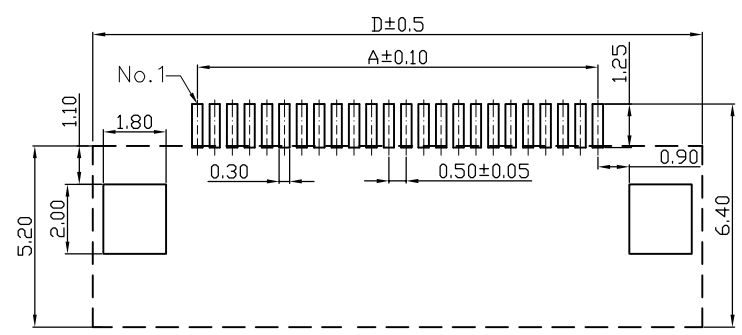
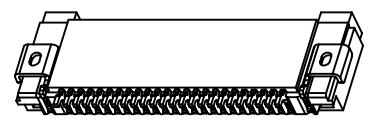
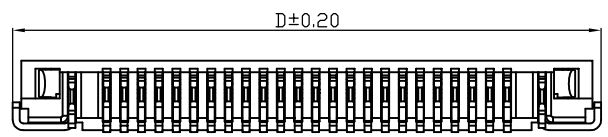

PCB Layout

GENERAL TOLERANCE SELECT <input checked="" type="checkbox"/> DN. TOL 1 2 3 X.XXX ±0.10±0.05±0.15 X.XX ±0.15±0.13±0.25 X.X ±0.20±0.25±0.5 X. ±0.30±0.36±1.00 ANGLE ±2°	UNITS mm	NAME: 0.5mm FPC 掀盖式	ATOM 深圳市爱特姆科技有限公司 SHENZHEN ATOM TECHNOLOGY CO.,LTD.		
	MAT'L	PART NO: F050**-09***	TITLE: 0.5mm FPC 掀盖式 (H=2.0mm)		
	FINISH	APPD: hyq	DWG NO. ATOM-A01135		
	Q'TY	CHKD: Vicky	SCALE SHEET REV 1:1 1 OF 1 C		
		DR: David			

X-ON Electronics

Largest Supplier of Electrical and Electronic Components

Click to view similar products for [FFC & FPC Connectors](#) category:

Click to view products by [ATOM](#) manufacturer:

Other Similar products are found below :

[HFW11R-1STE1H1LF](#) [FH29B-100S-0.2SHW\(99\)](#) [FA5S008HP1](#) [FH29B-120S-0.2SHW\(99\)](#) [FH29B-80S-0.2SHW\(99\)](#) [FHS-16](#) [FPH-2022G](#)
[52610-1075](#) [52610-1275](#) [52610-1934](#) [XF3M\(1\)-1415-1B-R100](#) [501864-3091-TR225](#) [0525594033](#) [086210010340800](#) [086222026001800](#)
[52271-2869-CUT-TAPE](#) [62674-201121DLF](#) [62684-36210E9ALF](#) [52610-1675](#) [52746-1671-TR250](#) [10051922-2810EHLF](#) [6-520415-9](#)
[BD021-09A-A1-0350-0200-0550-LD](#) [SFV6R-1STE9HLF](#) [XF3M-2915-1B-R100](#) [1658549-1](#) [62674-221121ALF](#) [46214008010800](#)
[046298003000883](#) [151660622](#) [842-816-2630-035](#) [AYF530665TA](#) [AYF351525](#) [046296011930846+](#) [AYF352325A](#) [046254020000800+](#)
[FH19C-13S-0.5SH\(99\)](#) [FH39J-51S-0.3SHW\(99\)](#) [AYF355125A](#) [AYF530365TA](#) [FH29B-44S-0.2SHW\(99\)](#) [SFW5R-2STAE9LF](#) [AYF351125A](#)
[AYF350725A](#) [62684-502100AHLF](#) [FH39-61S-0.3SHW\(99\)](#) [AYF414035A](#) [10064555-172520HLF](#) [AYF212335A](#) [504754-2500](#)