

ACAD GENERATED DRAWING. DON'T CHANGE BY HAND

REV	DATE	ECN NO.	MODIFICATION	APPROVER
B	2010/12/17	RD00310121701	版本升级	HYQ

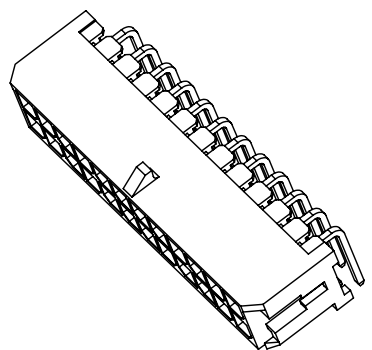
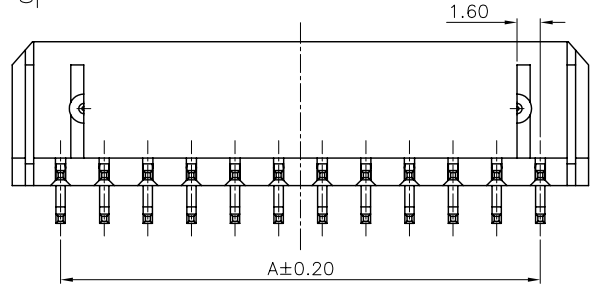
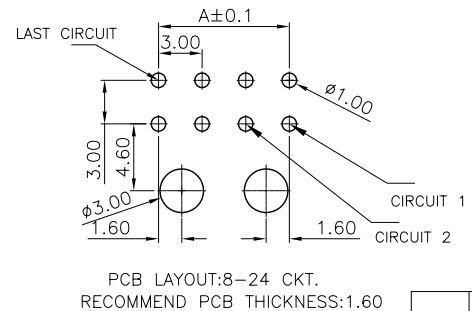
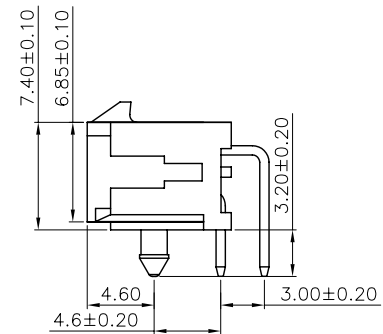
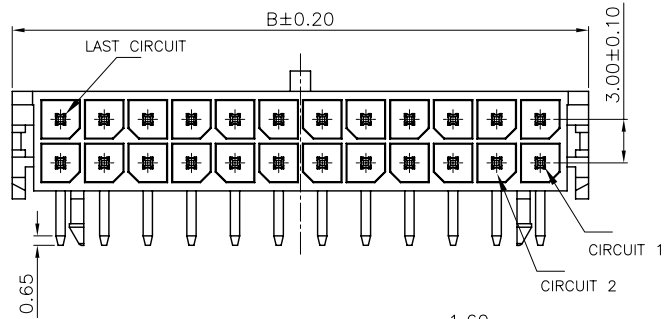
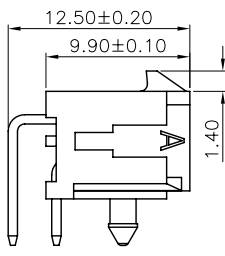
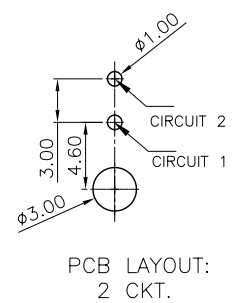
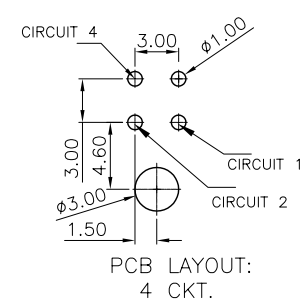
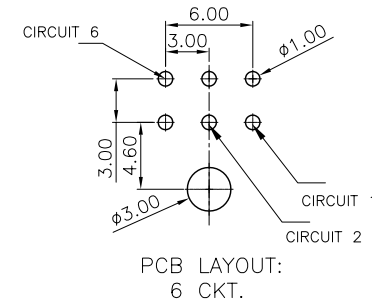
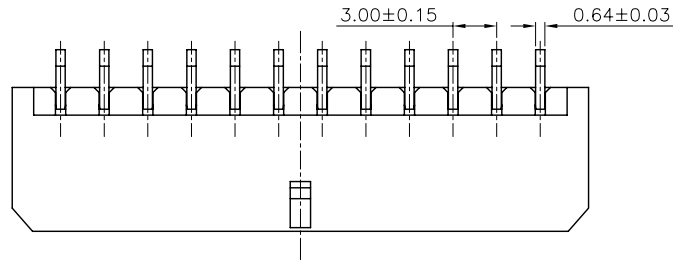

SPECIFICATION

- Material:
 - Housing: Thermoplastic, UL 94V-0, COLOR:BLACK.
 - Pin MATERIAL : BRASS ALLOY
 - FINISH: TIN PLATED OVER NICKEL PLATED
- Electrical Characteristics:
 - Voltage rating: 250V AC(RMS) or DC.
 - Current rating : 2.5A(max).
 - Operating Temperature: -25°C~+85°C.
 - Insulation resistance: 1000M ohms min. at 500VDC
 - Dielectric withstanding voltage: 1000 VAC/1minute.
 - Contact resistance: 20m ohms max.
- Applicable Wire:AWG#30~#20

Pin	DIMENSION	
	A	B
02	6.65	6.65
04	3.00	9.65
06	6.00	12.65
08	9.00	15.65
10	12.00	18.65
12	15.00	21.65
14	18.00	24.65
16	21.00	27.65
18	24.00	30.65
20	27.00	33.65
22	30.00	36.65
24	33.00	39.65

GENERAL TOLERANCE	UNITS mm	NAME: Wafer 3.0mm 2*XP	深圳市爱特姆科技有限公司 SHENZHEN ATOM TECHNOLOGY CO.,LTD.		
SELECT		MAT'L	PART NO: WF300** -08***	TITLE: Wafer 3.0mm 2*XP 90° 塑胶定位柱	
TOL.	1 2 3	FINISH	APPD: hyq	DWG NO. ATOM-A01469	
ON.		Q'TY	CHKD: Vicky		SCALE SHEET REV
X.XXX	±0.10±0.05±0.15		DR: Aimee		
X.XX	±0.15±0.13±0.25				
X.X	±0.20±0.25±0.5				
X.	±0.30±0.35±1.00				
ANGLE	±2'				

ACAD GENERATED DRAWING. DON'T CHANGE BY HAND

REV	DATE	ECN NO.	MODIFICATION	APPROVER
B	2010/12/17	RD00310121701	版本升级	HYQ

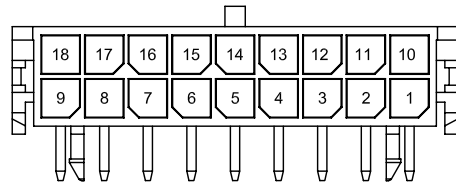

18-CKT.

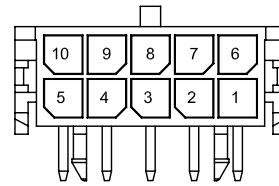

10-CKT.

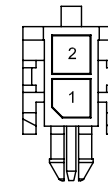

2-CKT.

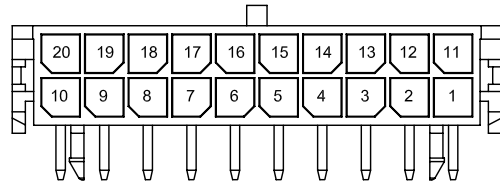

20-CKT.

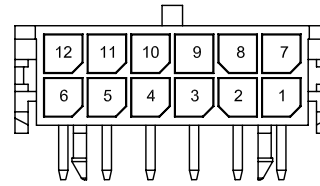

12-CKT.

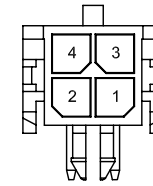

4-CKT.

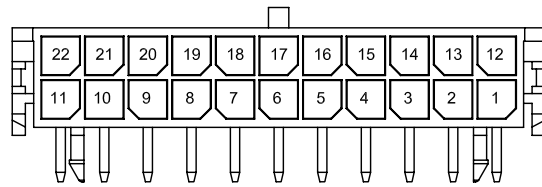

22-CKT.

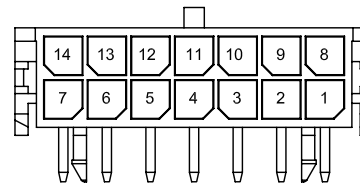

14-CKT.

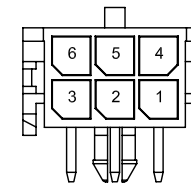

6-CKT.

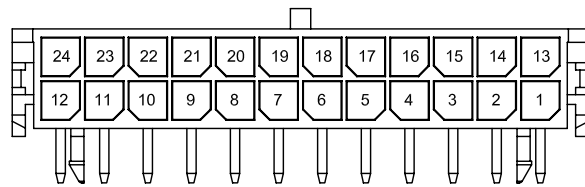

24-CKT.

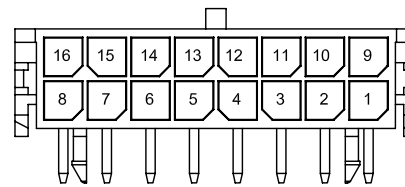

16-CKT.

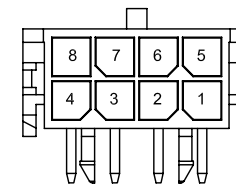

8-CKT.

2*1P--2*12P 结构对照图

GENERAL TOLERANCE			UNITS	NAME:	ATOM® 深圳市爱特姆科技有限公司 SHENZHEN ATOM TECHNOLOGY CO., LTD.			
SELECT	✓		mm	Wafer 3.0mm 2*XP	PART NO:	TITLE: Wafer 3.0mm 2*XP 90° 塑胶定位柱		
ON.	TOL.	1 2 3	MAT'L	WF300**--08***	APPD:	DWG NO. ATOM-A001469		
X.XXX	±0.10±0.05±0.15		FINISH	hyq	CHKD:	Vicky		
X.XX	±0.15±0.13±0.25		Q'TY	Aimee	DR:	Aimee		
X.X	±0.20±0.25±0.5					SCALE SHEET REV		
X.	±0.30±0.35±1.00					1:1	2/2	B
ANGLE	±2'							

X-ON Electronics

Largest Supplier of Electrical and Electronic Components

Click to view similar products for [Headers & Wire Housings](#) category:

Click to view products by [ATOM](#) manufacturer:

Other Similar products are found below :

[95000-104TRLF](#) [10135584-644402LF](#) [DF62W-EP2022PCA](#) [95000-106TRLF](#) [DF62W-2022SCA](#) [DF62W-EP2022PC](#) [2203348](#) [DF62W-2022SC](#) [1084018](#) [1029039](#) [1084017](#) [802-10-012-10-002000](#) [1112640](#) [1112639](#) [891-007-9SS-BST1T](#) [000-34000](#) [0008550134](#) [0009482033](#) [0009507031](#) [57102-F02-18ULF](#) [57102-S06-03LF](#) [57202-S52-04LF](#) [PCN6-15S-2.5E](#) [0039019024](#) [58102-G61-06LF](#) [582553-1](#) [0009485154](#) [0009508121](#) [0022285053](#) [0050291907](#) [018731A](#) [LY20-4P-DT1-P1E-BR](#) [02.125.8002.8](#) [60101931](#) [60598-1 \(Cut Strip\)](#) [M1625-3R/100](#) [61062-3](#) [61082-181009](#) [CSU011177004](#) [636-1427](#) [638009-1](#) [641938-9](#) [641991-4](#) [644168-1](#) [644827-2](#) [647662-1](#) [65039-019ELF](#) [65692-001LF](#) [65781-018](#) [65781-047](#)