



ATP I-Temp NVMe PCIe Gen3

M.2 2280 SSD (FWPLP)

N600Si

Datasheet

Version 3.2

P/N

AF120GSTJA-8BEIX

AF240GSTJA-8BEIX

AF480GSTJA-8BEIX

AF960GSTJA-8BEIX

AF1T92STJA-8BCIX



ATP I-Temp NVMe M.2 2280 SSD

Product Specification

- Capacities:
 - 120GB, 240GB, 480GB, 960GB, 1920GB
- Form Factors:
 - M.2 2280-D2-M
- Thickness:
 - Up to 3.5mm
- Weight:
 - <10 grams
- PCIe Gen3 x4 performance
 - Sequential Read: Up to 3,420MB/s
 - Sequential Write: Up to 3,050MB/s
- Read and Write IOPS (QD32)
 - Random 4K Reads: Up to 225,200 IOPS
 - Random 4K Writes: Up to 179,200 IOPS
- LDPC (Low Density Parity Check) ECC algorithm
- End-to-End Data Path Protection
- Firmware-Based Power Loss Protection (FW-PLP): Ensures Data-At-Rest Integrity
- Optional AES 256-bit Encryption, TCG OPAL 2.0
- Compliant with PCI Express Specification Rev.3.1a
- Compliant with PCIe M.2 Specification V1.1
- Compliant with NVMe Express Specification Rev.1.3
- Support
 - SMART command set support
 - TRIM command
 - Global wear-leveling
 - Thermal throttling mechanism
- Power
 - 3.3V Input Power
- Temperature, Case (T_c)
 - Operating: -40°C to 85°C
 - Non-Operating: -40°C to 85°C
- Reliability
 - MTBF (Mean Time Between Failure): 2,000,000 hours
 - Shock (Non-operating): Half Sine 1,500G /0.5ms
 - Vibration (Non-operating): Sine 16.4G /10~2000Hz
 - Data Retention (@30°C): 5 Years (with 10% P/E Cycles)
- Endurance (TBW in Sequential Write)
 - 120GB: 349 TB
 - 240GB: 698 TB
 - 480GB: 1,396 TB
 - 960GB: 2,793 TB
 - 1920GB: 5,585 TB
- Certifications and Declarations
 - CE
 - FCC
 - BSMI
 - UKCA
- Product Ecological Compliance
 - RoHS
 - REACH



CONTENT

Disclaimer	1
Revision History	2
1.0 Product Specification	3
1.1 Product Image.....	3
1.2 Capacity	3
1.3 Environment Specifications.....	4
1.4 Reliability.....	4
1.5 Electrical Characteristics	5
1.6 IOPS.....	6
1.7 Maximum Read/Write Performance	6
1.8 Write/Erase Endurance ¹	6
2.0 Product Overview	7
2.1 Block Diagram.....	7
2.2 Auto-Refresh Technology --Data Integrity Protection.....	8
3.0 Mechanical Dimension & NVMe SSD Pin Assignment	9
3.1 Mechanical Form Factor (Units in mm)	9
3.2 Pin Location.....	10
3.3 Pin Assignment.....	10
4.0 Command Set	12
4.1 Administrative Command Set	12
4.2 NVM Command Sets	12
4.3 Get Log Page	13
4.4 Get/Set Feature.....	13
4.5 SMART Information.....	14
5.0 Part Number Decoder	16
6.0 Certification and Declarations	17



Disclaimer

ATP Electronics Inc. shall not be liable for any errors or omissions that may appear in this document and disclaims responsibility for any consequences resulting from the use of the information set forth herein.

ATP may make changes to specifications and product descriptions at any time, without notice. The information in this paper is furnished for informational use only so ATP assumes no responsibility or liability for any errors or inaccuracies that may appear in this document.

All parts of the ATP documentation are protected by copyright law and all rights are reserved. This documentation may not, in whole or in part, be copied, photocopied, reproduced, translated, or reduced to any electronic medium or machine-readable form without prior consent, in writing, from ATP Electronics, Inc.

Notwithstanding any clause of this Agreement, Supplier are not warranted and liable for use any Product in developing, or for incorporation into, products or services used in applications or environments requiring failsafe performance, such as in the operation of nuclear facilities, aircraft navigation or air traffic control, life support machines, surgically implanted devices, weapons systems, or other applications, devices or systems in which the failure of Product could lead directly to death, personal injury, or severe physical or environmental damage.

The information set forth in this document is considered to be “Proprietary” and “Confidential” property owned by ATP.

© Copyright ATP all rights reserved.



Revision History

Date	Version	Changes compared to previous issue
Sept. 23 th , 2021	3.0	- 1 st release
Oct. 13 th , 2021	3.1	- Update TBW (Random Write)
Mar. 15 th , 2022	3.2	- Update Firmware PLP description



1.0 Product Specification

1.1 Product Image

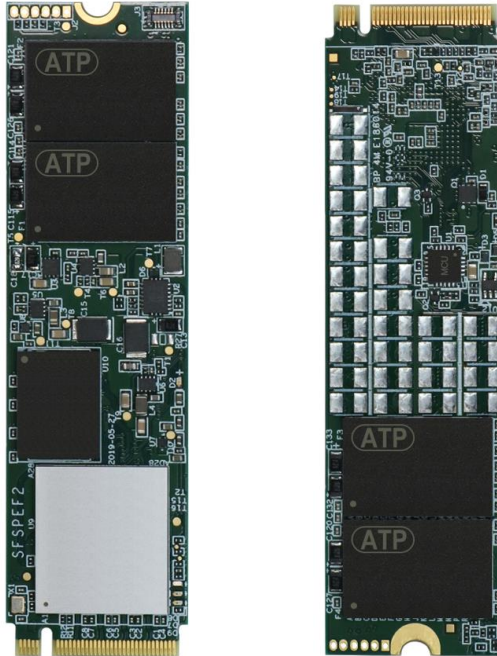

Figure 1-1: ATP Product Image (For Reference)

1.2 Capacity

Table 1-2: Capacity Settings

Capacity	LBA
120GB	234,441,648
240GB	468,862,128
480GB	937,703,088
960GB	1,875,385,008
1920GB	3,750,748,848

Note:

1. Sector size is 512 bytes
2. LBA counts are based on IDEMA (LBA1-03) standard



1.3 Environment Specifications

Table 1-3-1: Environment Specification

Type		Standard
Temperature, Case (T _C) ¹	Operating	-40°C to 85°C
	Non-Operating	-40°C to 85°C
Airflow ^{2,3,4}	Operating	600 LFM @ Max. T _C
Rate of Temp. Change	Operating	1~2°C / minute
Relative Humidity	Operating	8% to 95%, noncondensing
	Non-Operating	8% to 93%, noncondensing
Vibration	Operating	Sine 16.4G, 10~2000Hz
Shock	Operating	Half sine 1500G/0.5ms

1. Case temperature, the composite temperature as indicated by SMART temperature attribute. (ID:2)
2. Sufficient airflow is recommended for 100% sequential writes as the SSD approaches the case temperature in effort to maintain best performance. In the case the SSD temperature exceeds the assigned case temp, the SSD will throttle the performance to mitigate thermal challenges.
3. Airflow is measured upstream of the drive and flows parallel to and through any cooling fins.
4. For more information, please contact your local ATP representative.

1.4 Reliability

Table1-4: Reliability

Type	Value
MTBF (@ 25°C) ¹	>2,000,000 hours
Data Retention (@ 30°C) ²	5 years (with 10% P/E cycle)

Notes:

1. The Mean Time between Failures (MTBF) is calculated using a prediction methodology, Telcordia SR-332, which based on reliability data of the individual components in drive. It assumes nominal voltage, with all other parameters within specified range.
2. Data retention value may vary across different temperature range and is experimental result to be used for reference.



1.5 Electrical Characteristics

Table 1-5-1: Supply Power

Parameter	Symbol	Min	Typ.	Max	Unit	Remark
Supply voltage	V _{CC}	3.15	3.3	3.45	V	

Table 1-5-2: Power Consumption Measurement

120GB

Parameter	Symbol	Min	Typ.	Max	Unit	Remark
Sustained write power	P _W	-	2.7	3.2	W	RMS value
Sustained read power	P _R	-	2.6	3.1	W	RMS value
Idle power	P _S	-	0.9	1.1	W	RMS value

240GB

Parameter	Symbol	Min	Typ.	Max	Unit	Remark
Sustained write power	P _W	-	3.3	4.3	W	RMS value
Sustained read power	P _R	-	3.0	4.1	W	RMS value
Idle power	P _S	-	0.9	1.1	W	RMS value

480GB

Parameter	Symbol	Min	Typ.	Max	Unit	Remark
Sustained write power	P _W	-	4.0	5.4	W	RMS value
Sustained read power	P _R	-	3.0	4.6	W	RMS value
Idle power	P _S	-	0.9	1.1	W	RMS value

960GB

Parameter	Symbol	Min	Typ.	Max	Unit	Remark
Sustained write power	P _W	-	4.6	7.2	W	RMS value
Sustained read power	P _R	-	3.2	5.3	W	RMS value
Idle power	P _S	-	0.9	1.3	W	RMS value

1920GB

Parameter	Symbol	Min	Typ.	Max	Unit	Remark
Sustained write power	P _W	-	4.5	8.9	W	RMS value
Sustained read power	P _R	-	3.0	5.0	W	RMS value
Idle power	P _S	-	1.0	1.5	W	RMS value

Notes:

1. All power measured is under room temperature and using PCIe interface.
2. Sequential power measured under 100% read mode or 100% write mode with 1023KB data transfers.



1.6 IOPS

Table 1-6: IOPS (QD32) (Up to)

Capacity	4K Random Read IOPS (QD32)	4K Random Write IOPS (QD32)
120GB	108,800	117,000
240GB	198,000	138,000
480GB	206,300	165,500
960GB	222,700	176,600
1920GB	225,200	179,200

Notes:

1. IOPS may vary by application/system usage
2. IOPS is calculated by dividing capacity by (4K QD32 testing result)/4x1024
3. The testing is assumed under clean state and done in room temperature

1.7 Maximum Read/Write Performance

Table 1-7: Performance (Up to)

Type	Capacity	Sequential Read	Sequential Write
Crystal Disk Mark	120GB	1,835 MB/s	580 MB/s
	240GB	3,400 MB/s	1,170 MB/s
	480GB	3,420 MB/s	2,350 MB/s
	960GB	3,420 MB/s	3,050 MB/s
	1920GB	3,420 MB/s	3,050 MB/s

Notes:

1. Performance may vary by application/system usage
2. Performance is measured by CrystalDiskMark in room temperature. The testing drive is assumed under clean state.

1.8 Write/Erase Endurance¹

Table 1-8: TBW

Capacity	Random write ²	Sequential write ³
120GB	104 TB	349 TB
240GB	208 TB	698 TB
480GB	416 TB	1,396 TB
960GB	832 TB	2,793 TB
1920GB	1,664 TB	5,585TB

1. Endurance can be predicted based on the usage conditions applied to the device, the internal NAND component cycles, the write amplification factor, and the wear leveling efficiency of the drive. TBW may vary depending on application, please contact ATP for TCO evaluation if specific usage type applies.
2. The random endurance calculation is based on JESD219A Enterprise workload.
3. The sequential write endurance calculation is based on pure sequential write at 128K transfer size to run in 4K alignment test pattern



2.0 Product Overview

2.1 Block Diagram

ATP SSD consists of below functional blocks. The advanced architecture is optimized to provide highest data reliability and transfer performance.

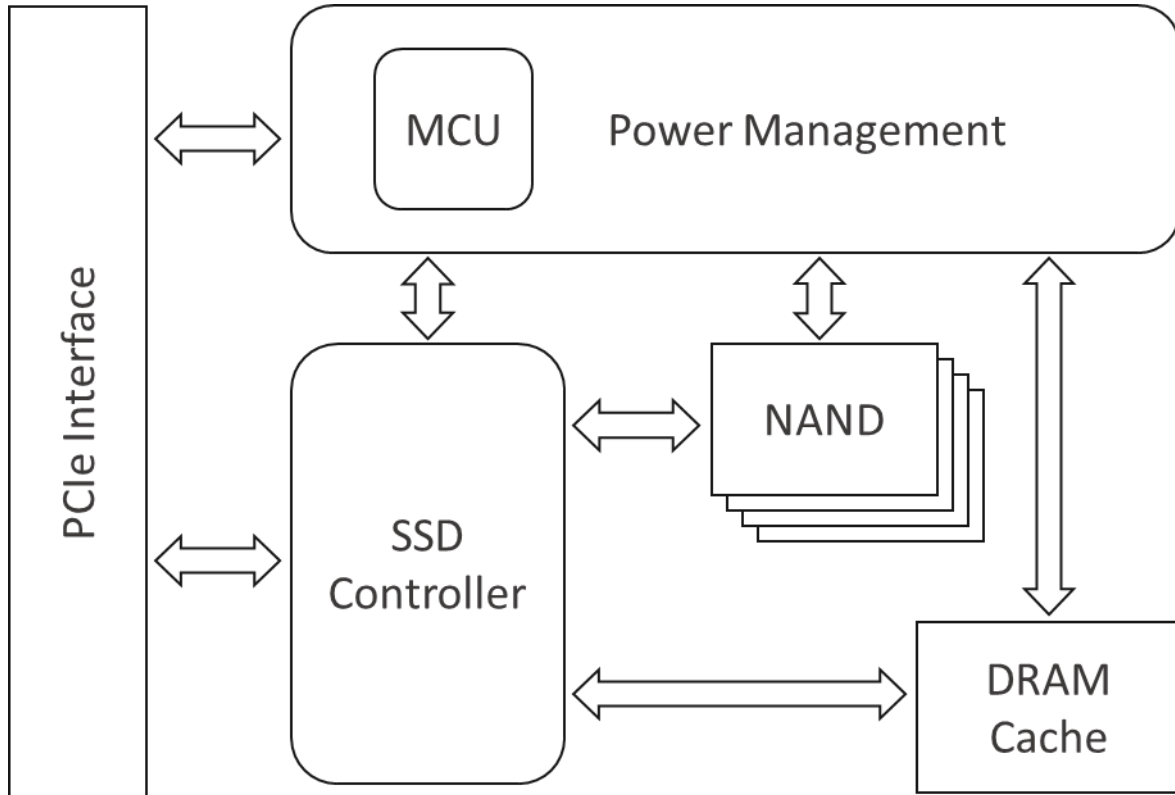

Figure 2-1: Block diagram for ATP NVMe SSD



2.2 Auto-Refresh Technology --Data Integrity Protection

Over time the error bits accumulate to the threshold in the flash memory cell and eventually become uncorrectable despite the use of an ECC engine. In the traditional handling method, the data is moved to a different location in the flash memory; despite the corrupted data is beyond repaired before the transition.

The situation is worse in frequent read applications, such as navigation systems or OS boot-up devices. The map or operating system is preloaded into the storage media and there may be one time write and following by read operation only. Read disturbance is the result of electrical interference from multiple read operations in surrounding cells. After NAND flash accumulates 100,000 read cycles, uncorrectable ECC errors may occur in the affected pages which results in data failure in the same block.

To prevent data corruption, ATP memory product monitors the error bit levels in each read operation. When it reaches the preset threshold value, Auto-Refresh is activated by programming the data into another block before the data is corrupted. After the re-programming operation is completed, the controller reads the data and compares the data/parity to ensure data integrity.

Owing to different user experiences, please contact ATP for Auto-Refresh in real applications.



3.0 Mechanical Dimension & NVMe SSD Pin Assignment

3.1 Mechanical Form Factor (Units in mm)

Table 3.1: Mechanical Dimension

Type	Value	
M.2 2280-D2-M	Length	80 mm +/- 0.15
	Width	22 mm +/- 0.15
	Thickness	3.5mm (MAX)

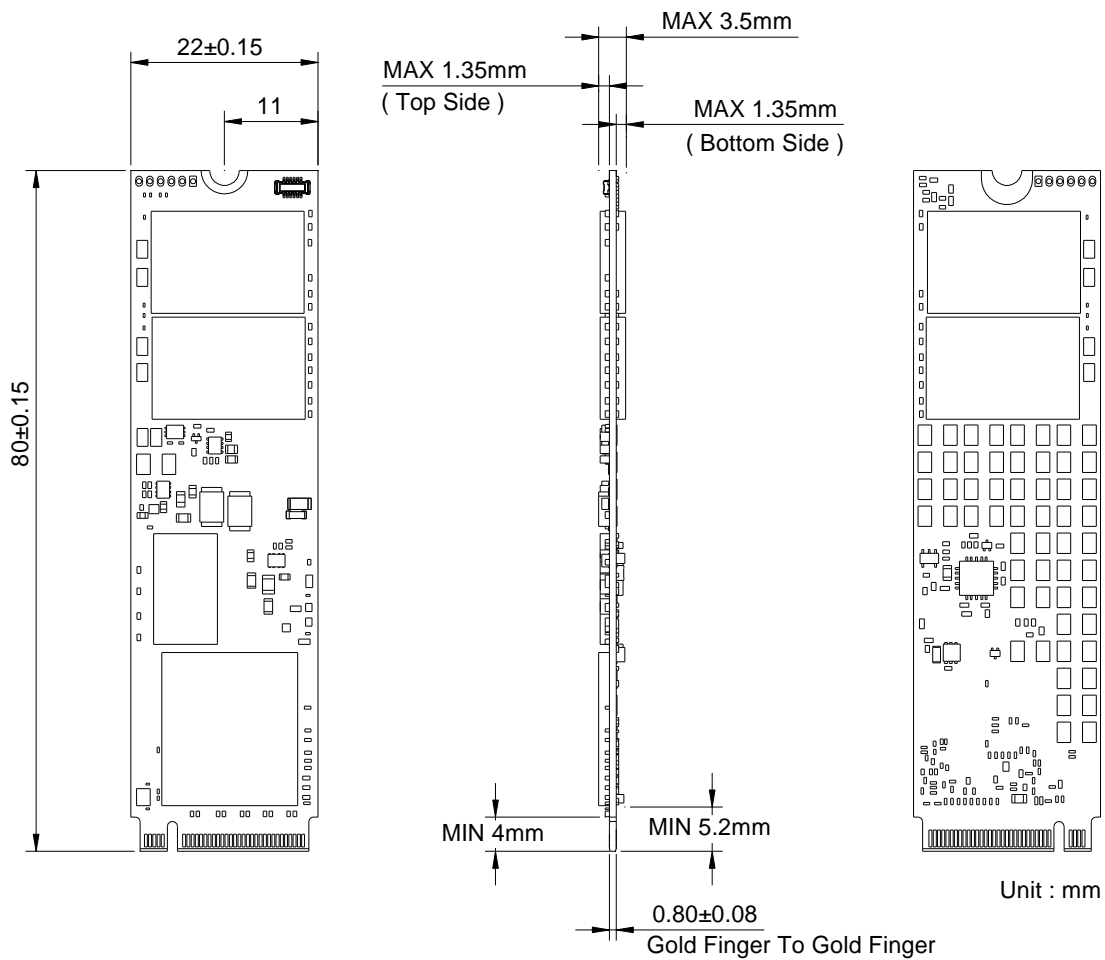

3.2 Pin Location

The following figure shows the pin location of the M.2 Embedded SSD, the golden finger is with both signal and power segments.

Figure 3-2

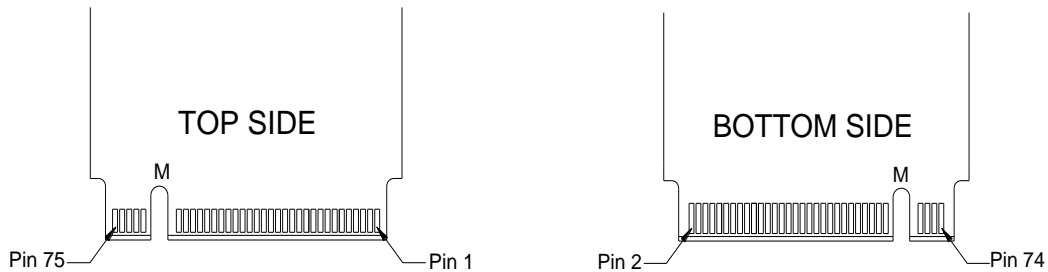

3.3 Pin Assignment

Pin assignment in show in Table 3-1 below.

Table 3-1

Pin No.	Function	Description	Pin No.	Function	Description
1	GND	Ground	2	3.3V	3.3 V Source
3	GND	Ground	4	3.3V	3.3 V Source
5	PETn3	PCIe 3 Transmit(-)	6	N/C	No Connect
7	PETp3	PCIe 3Transmit(+)	8	N/C	No Connect
9	GND	Ground	10	LED1# (O)	LED
11	PERn3	PCIe 3 Receive(-)	12	3.3V	3.3 V Source
13	PERp3	PCIe 3 Receive(+)	14	3.3V	3.3 V Source
15	GND	Ground	16	3.3V	3.3 V Source
17	PETn2	PCIe 2 Transmit(-)	18	3.3V	3.3 V Source
19	PETp2	PCIe 2Transmit(+)	20	N/C	No Connect
21	GND	Ground	22	N/C	No Connect
23	PERn2	PCIe 2 Receive(-)	24	N/C	No Connect
25	PERp2	PCIe 2 Receive(+)	26	N/C	No Connect
27	GND	Ground	28	N/C	Force ROM
29	PETn1	PCIe 1 Transmit(-)	30	N/C	No Connect
31	PETp1	PCIe 1Transmit(+)	32	N/C	No Connect
33	GND	Ground	34	N/C	No Connect



Pin No.	Function	Description	Pin No.	Function	Description
35	PERn1	PCIe 1 Receive(-)	36	N/C	No Connect
37	PERp1	PCIe 1 Receive(+)	38	N/C	No Connect
39	GND	Ground	40	SMB_CLK(I/O)	No Connect
41	PETn0	PCIe 0 Transmit(-)	42	SMB_DATA(I/O)	No Connect
43	PETp0	PCIe 0 Transmit(+)	44	ALERT# (O)	Reserved No Connect
45	GND	Ground	46	N/C	No Connect
47	PERn0	PCIe 0 Receive(-)	48	N/C	No Connect
49	PERp0	PCIe 0 Receive(+)	50	PERST# (I) 3.3V	PCIe Reset
51	GND	Ground	52	CLKREQ# (I/O) (0/3.3V)	Clock Request
53	REFCLKn	REFCLKn	54	PEWAKE# (I/O) (0/3.3V)	Reserved No Connect
55	REFCLKp	REFCLKp	56	Reserved for MFG_DATA	UART_RX
57	GND	Ground	58	Reserved for MFG_CLOCK	UART_TX
Module Key			Module Key		
67	N/C	No Connect	68	SUSCLK(32kHz) (I) (0/3.3V)	No Connect
69	NC-PCIe	Reserved No Connect	70	3.3V	3.3V Source
71	GND	Ground	72	3.3V	3.3V Source
73	GND	Ground	74	3.3V	3.3V Source
75	GND	Ground			



4.0 Command Set

4.1 Administrative Command Set

ATP NVMe SSD supports the following Administrative Command Sets:

Table 4-1

Opcode	Optional/Mandatory	Command
00h	M	Delete I/O Submission Queue
01h	M	Create I/O Submission Queue
02h	M	Get Log Page
04h	M	Delete I/O Completion Queue
05h	M	Create I/O Completion Queue
06h	M	Identify
08h	M	Abort
09h	M	Set Feature
0Ah	M	Get Feature
0Ch	M	Asynchronous Event Request
10h	O	Firmware Commit
11h	O	Firmware Image Download
14h	O	Device Self-test
NVM Command Set Specific		
80h	O	Format NVM
81h	O	Security Send
82h	O	Security Receive
84h	O	Sanitize

4.2. NVM Command Sets

ATP NVMe SSD supports the following NVM Command Sets:

Opcode	Optional/Mandatory	Command
00h	M	Flush
01h	M	Write
02h	M	Read
04h	O	Write Uncorrectable
05h	O	Compare
08h	O	Write Zeros
09h	O	Dataset Management



4.3. Get Log Page

ATP NVMe SSD supports the following Get Log Page:

Table 4-3

Opcode	Optional/Mandatory	Command
01h	M	Error Information
02h	M	SMART/Health Information
03h	M	Firmware Slot Information
05h	O	Command Effects Log
06h	O	Device Self-test
07h	O	Telemetry Host-Initiated
08h	O	Telemetry Controller-Initiated

4.4. Get/Set Feature

ATP NVMe SSD supports the following Get/Set Feature:

Table 4-4

Opcode	Optional/Mandatory	Command
01h	M	Arbitration
02h	M	Power Management
03h	O	LBA Range Type
04h	M	Temperature Threshold
05h	M	Error Recovery
06h	O	Volatile Write Cache
07h	M	Number of Queues
08h	M	Interrupt Coalescing
09h	M	Interrupt Vector Configuration
0Ah	M	Write Atomicity Normal
0Bh	M	Asynchronous Event Configuration
0Ch	O	Autonomous Power State Transition
0Eh	O	Timestamp
10h	O	Host Controlled Thermal Management
NVM Command Set Specific		
80h	O	Software Progress Marker



4.5. SMART Information

ATP NVMe SSD supports S.M.A.R.T. Attributes.

Table 4-5

ID	Byte Address	Bytes	Attribute Name
1	0	1	Critical Warning
2	1~2	2	Composite Temperature
3	3	1	Available Spare
4	4	1	Available Spare Threshold
5	5	1	Percentage Used
6	32~47	16	Data Units Read
7	48~63	16	Data Units Written
8	64~79	16	Host Read Commands
9	80~95	16	Host Write Commands
10	96~111	16	Controller Busy Time
11	112~127	16	Power Cycles
12	128~143	16	Power On Hours
13	144~159	16	Unsafe Shutdowns
14	160~175	16	Media and Data Integrity Errors
15	176~191	16	Number of Error Information Log Entries
16	192~195	4	Warning Composite Temperature Time
17	196~199	4	Critical Composite Temperature Time
18	200~201	2	Device Temperature
19	202~203	2	Normalized ASIC Temperature
20	216~219	4	Thermal Management Temperature 1 Transition Count
21	220~223	4	Thermal Management Temperature 2 Transition Count
22	224~227	4	Total Time For Thermal Management Temperature 1
23	228~231	4	Total Time For Thermal Management Temperature 2
24	232~233	2	Reallocated Flash Blocks Count
25	234~235	2	Initial Spare Blocks
26	236~239	4	Uncorrectable Sector Count
27	240~243	4	Total Block Program Failure
28	244~247	4	Reported Uncorrectable Errors
29	248~251	4	Hardware ECC Recovered
30	252~255	4	Current Pending Block Count
31	256~259	4	Offline Surface Scan
32	260~263	4	Total Block Erase Failure
33	264~267	4	Maximum Erase Count
34	268~271	4	Average Erase Count



ID	Byte Address	Bytes	Attribute Name
35	272~279	8	Total Erase Count
36	280~287	8	Total Sectors Read from NAND Flash
37	288~295	8	Total Host Sectors Written to Device
38	296~303	8	Total NAND Sectors Written to NAND Flash
39	304~311	8	Total Host Sectors Read from Device
40	312~315	4	CRC Error
41	316~319	4	Raw Read Error Count
42	320	1	Thermal Throttle Stage





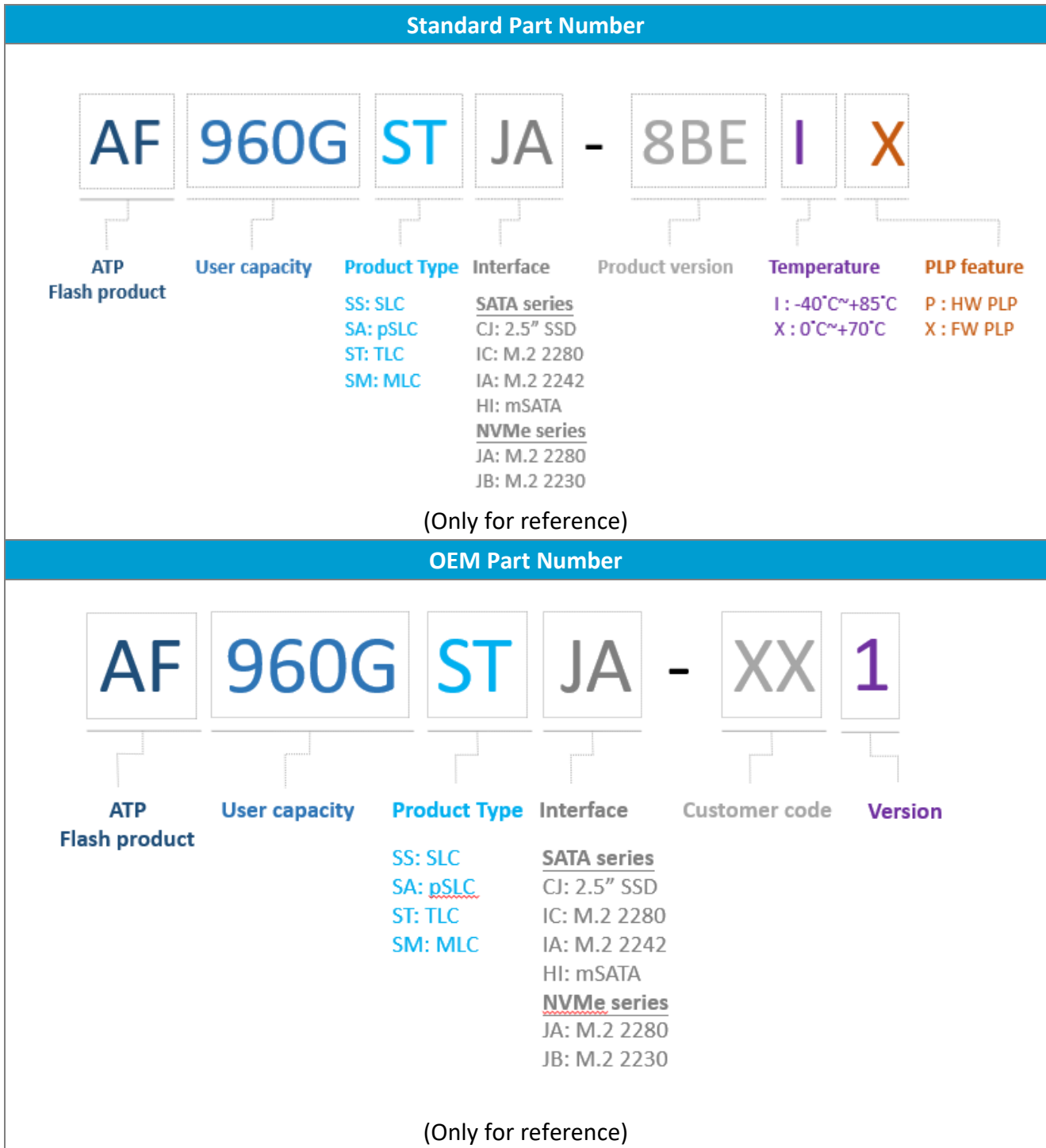

5.0 Part Number Decoder





6.0 Certification and Declarations

Certification	Mark	Description
CE compliant		The CE marking (also known as CE mark) is a mandatory conformance mark on many products placed on the single market in the European Economic Area (EEA). The CE marking certifies that a product has met EU consumer safety, health or environmental requirements. CE stands for Conformité Européenne, "European conformity" in French.
FCC		FCC Part 15 Class B was used for Evolution of United States (US) Emission Standards for Commercial Electronic Products, The United States (US) covers all types of unintentional radiators under Subparts A and B (Sections 15.1 through 15.199) of FCC 47 CFR Part 15, usually called just FCC Part 15
BSMI compliant		BSMI logo signifies the product is compliant with Taiwan EMC standard for CNS13438.
UKCA		The UKCA (UK Conformity Assessed) marking is a new UK product mark for the products that conforms to the CE marking and sold in Great Britain, which is effective from 1 st of January 2021.
RoHS	-	Compliant with the Restriction of Hazardous Substances (RoHS) Directive (2011/65/EU)
REACH	-	Compliant with REACH (Registration, Evaluation, Authorization and Restriction of Chemicals which is an EU Regulation that came into force on 1 June 2007

www.atpinc.com

ATP TAIWAN (HQ)
 TEL: +886-2-2659-6368
 FAX: +886-2-2659-4982
 sales-apac@atpinc.com

ATP USA
 TEL: +1-408-732-5000
 FAX: +1-408-732-5055
 sales@atpinc.com

ATP JAPAN
 TEL: +81-3-6890-8277
 FAX: +81-3-6890-8301
 sales-japan@atpinc.com

ATP EUROPE
 TEL: +49-89-3749999-0
 FAX: +49-89-3749999-29
 sales-europe@atpinc.com

ATP CHINA
 TEL: +86-21-5080-2220
 FAX: +86-21-9687-0000-026
 sales@cn.atpinc.com

X-ON Electronics

Largest Supplier of Electrical and Electronic Components

Click to view similar products for [Solid State Drives - SSD category](#):

Click to view products by [ATP Electronics manufacturer](#):

Other Similar products are found below :

[MTFDDAC512MAM-1K1](#) [ASD25-MLC064G-CT-160-1](#) [SQF-SM4V2-256G-SBC](#) [MTFDDAA120MBB-2AE1ZABYY](#)
[MTFDDAA240MBB-2AE1ZABYY](#) [SQF-S25V4-240G-SCC](#) [SQF-SDMM2-256G-S9E](#) [MTFDKBA400TFS-1BC1ZABYY](#)
[MTFDKBZ3T8TFR-1BC1ZABYY](#) [MTFDKBA800TFS-1BC1ZABYY](#) [SQF-SMSZ2-64GCSBC](#) [B92.225HGV.00205](#) [APM128GMFFN-6BTM1GW](#) [MTFDDAK060MBD-1AH12ITYY](#) [MTFDDAK960MBP-1AN16ABYY](#) [VSF202PC016G-100](#) [AF512GSMEL-VABIP](#) [FFD-25-SATA-1-A](#) [2400022](#) [2913199](#) [2701112](#) [MTFDDAV512TBN-1AR1ZABYY](#) [SSDPEKKA256G801](#) [2400338](#) [2400335](#) [MTFDDAV256TBN-1AR12ABYY](#) [SSDPEKKA020T801](#) [MTFDDAK064MBD-1AH12ITYY](#) [MTFDDAK800MBP-1AN1ZABYY](#) [EP-SSMSF128AACS](#) [SQF-S25U8-128G-SAE](#) [A52.255LHB.00246](#) [AP-FD25C23E0064GS-5TM](#) [AP-FD25C23E0128GS-W5TM](#) [AP-FM008GD2505S-TW1M](#) [AP-FM008GD2505S-T1H](#) [APM256GMFFN-4BTM1GW](#) [APM2T42SM22032GFN-4FTM](#) [APM2T80SM21256GAS-4BTMG](#) [APS297F064G-4BTM1GF](#) [APM016GNEAN-4ETM1](#) [AF8GSSHI-VACXP](#) [AF32GSMEL-VAEIP](#) [AF256GSMEL-VABIP](#) [AF16GSSIA-VAAXP](#)
[AF32GSSHI-VACXP](#) [AF240GSTIC-7BEXP](#) [AF480GSTJA-8BEIX](#) [GLS86FP512G3-I-BZ000](#) [GLS87BP001T3-C-BZ200](#)