

SPECIFICATION:

1. ELECTRICAL
 - 1.1 Current Rating: 5A for Vbus; 1.25A for Vconn & GND; 0.25A for other pin
 - 1.2 Voltage Rating: 5VAC max
 - 1.3 Contact Resistance: 40mΩ
 - 1.4 Insulation Resistance: 100MΩ
 - 1.5 Dielectric Withstanding Voltage: 100VAC
2. MECHANICAL
 - 2.1 Durability: 10,000 cycles
 - 2.2 Insertion Force: 5 to 20N
 - 2.3 Extraction Force: 8 to 20N
3. ENVIRONMENTAL
 - 3.1 Operating temperature range: -55°C~+85°C
 - 3.2 Storage temperature range: -55°C~+85°C
 4. Can transfer data at up to 10 Gbit/s

NO.	PART NAME	DESCRIPTION
1	HOUSING	LCP, UL94V-0, Black
2	CONTACT	Thin plating on solder tail, under plated Nickel Copper Alloy, 5u" Gold plating on contact area
3	SHELL	SUS304, T=0.30mm, 100u" Nickel
4	SHIELD	Stainless Steel, T=0.15mm

UNITS: DECIMAL LINEAR ANGLES		UNLESS OTHERWISE SPECIFIED TOLERANCE	
mm	X	±0.50	±5°
	XX	±0.25	±3°
	XXX	±0.12	±1°

SCALE	4/1
SHEET	1/2
SIZE	A4
FILE NAME	217B-BC02_B_1
PRODUCT NO.	217B-BC02
APPROVED	Ken
CHECKED	Fros
DRAWN	Thm
DRAWN NAME:	2018/09/10
DRAWN NAME:	2018/09/10
DRAWN NAME:	WWW.ATTEND.COM.TW

REV.	DESCRIPTION	DRAWN	DATE
1	INITIAL RELEASE	TIM	2018/09/10

RECOMMENDED LAYOUT (TOP VIEW)
GENERAL TOLERANCE: ±0.05mm

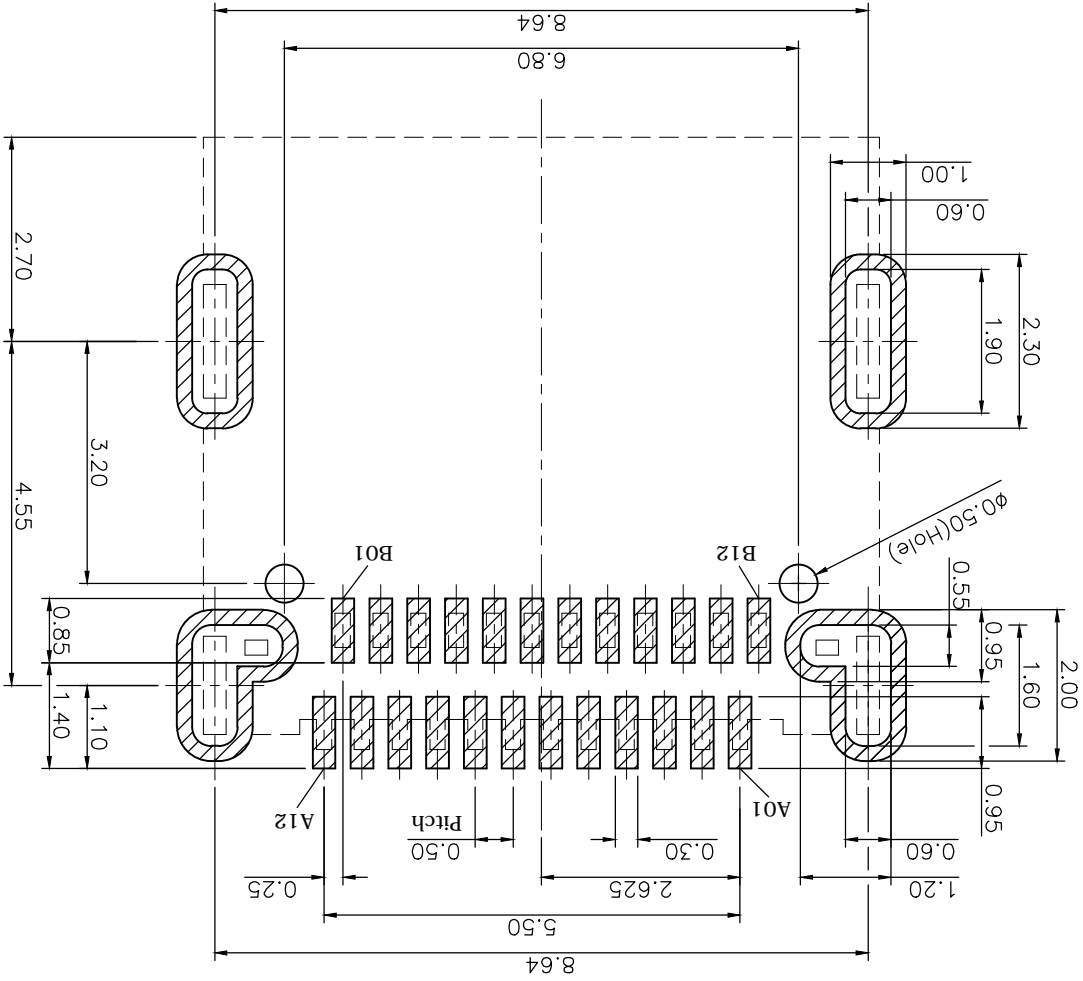
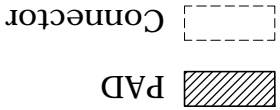

PIN ASSIGNMENTS:

PIN NUMBER	SIGNAL NAME	PIN NUMBER	SIGNAL NAME
A1	GND	B12	GND
A2	SSTXp1	B11	SSTXp1
A3	SSTXn1	B10	SSTXn1
A4	VBUS	B9	VBUS
A5	CC1	B8	SBU2
A6	Dp1	B7	Dn2
A7	Dn1	B6	Dp2
A8	SBU1	B5	CC2
A9	VBUS	B4	VBUS
A10	SSRXn2	B3	SSTXn2
A11	SSRXp2	B2	SSTXp2
A12	GND	B1	GND

UNLESS OTHERWISE SPECIFIED TOLERANCE	
UNIT:	DECIMAL LINEAR ANGLES
mm	X ±0.50
	X.X ±0.25
	X.XX ±0.12
	±1°
DRAWN NAME: WWW.ATTEND.COM.TW	
DRAWN: Tlm	
CHECKED: Fros	
APPROVED: Ken	
SCALE: 10/1	SHEET: 2/2
SIZE: A4	FILE NAME: 217B-BC02_B_1
PRODUCT NO.: 217B-BC02	2018/09/10
2018/09/10	2018/09/10
DRAWN NAME: USB Type C Receptacle	
Dual Row SMT Type.5u"	



REV.	DESCRIPTION	DRAWN	DATE
	see sheet one		

Carton L*W*H=355*355*355

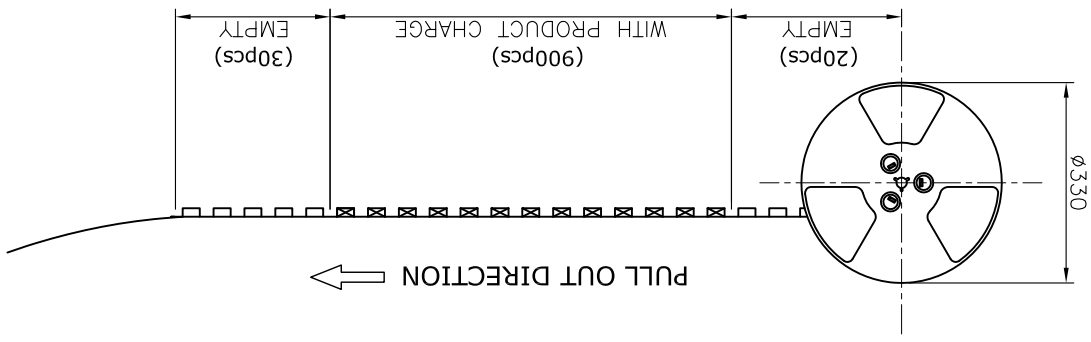
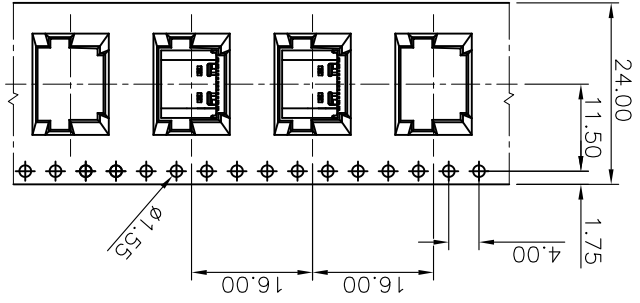
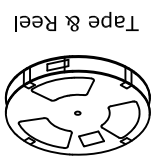
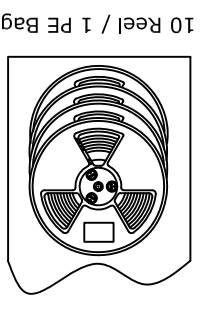
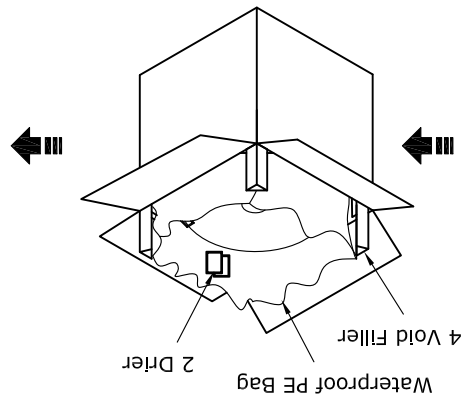
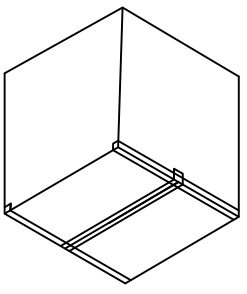

PACKAGING SPECIFICATION:
 Quantity:
 900 Piece/ Reel
 10 Reel/ Carton
 9,000 Piece/ Outer Carton

UNLESS OTHERWISE SPECIFIED TOLERANCE		DECIMAL	LINEAR	ANGLES
UNIT:	mm	X.X	±0.50	±5°
		X.X	±0.25	±3°
		X.XX	±0.12	±1°
DRAWN	Ttm	2018/09/10		
CHECKED	Fros	2018/09/10		
APPROVED	Ken	2018/09/10	SCALE	SHEET
			NA	1/1
			SIZE	A4
FILE NAME	217B-BC02_D_1			
PRODUCT NO.	217B-BC02			
DRAWN NAME:	USB Type C Receptacle Packing			
WWW.ATTEND.COM.TW				



REV.	DESCRIPTION	DRAWN	DATE
1	INITIAL RELEASE	TIM	2018/09/10

X-ON Electronics

Largest Supplier of Electrical and Electronic Components

Click to view similar products for [USB Cables / IEEE 1394 Cables](#) category:

Click to view products by [Attend manufacturer](#):

Other Similar products are found below :

[68768-0173](#) [FNY-W6003-01](#) [88764-0800](#) [13805532](#) [148700-1](#) [17-200621](#) [17-250051P](#) [954](#) [AC102012-2](#) [IP-USB1\(C10\)S-RW](#)
[CABLE/RTP/USB/DT](#) [0847290003](#) [10115240-12200LF](#) [RS232-GTD](#) [USBFTVX2SA2N03A](#) [USBFTV2SA2N03A](#) [1689404-1](#) [FTP-](#)
[629Y401](#) [FTP-628Y402](#) [943301-001](#) [FNY-W6022](#) [FNY-W6003-03](#) [1310-1015-05](#) [1310-1018-04](#) [1310-1019-04](#) [0887283402](#) [UA-](#)
[30AMFM-SL7B02](#) [UA-30AMFM-SL7B01](#) [UA-30AFM-LD7B03](#) [UA-30AMFM-SL7B03](#) [USBAPSCC7202A](#) [UES-1001A160](#) [UES-](#)
[1003A160](#) [USBFTVX7SA2N20A](#) [USBFTVX2SA2N20A](#) [USBFTV2PEMSA2N10A](#) [FTP-629Y602](#) [USBCAMCM100](#) [USB A/F*2 to 2.54](#)
[2*5P-SH L=400mm](#) [EP-CBUSB10P2FLT](#) [1310-1033-01](#) [1310-1037-04](#) [ASR-USB](#) [68784-0075](#) [17-241361](#) [17-230471](#) [217B-BC02](#) [USB-29](#)
[19800-010500-200-RS](#) [USB+MINI DIN 6P WITH BKT](#)