



RTX-868-NB-UART is a SMD multichannel narrow band transceiver operating in 868.00 - 868.60 MHz band allowing long distances with very low power consumption.

The module can be easily interfaced to the application microprocessor via UART bus and few GPIOs, data packet can be up to 64 bytes.

Due to Low sleep power consumption and fast wakeup the device is suitable for key fobs, motor drive control boards, battery powered sensors requiring very low power consumption, low cost application and high radio performance.

Available 5 channel 25KHz wide in GFSK modulation selectable by external pin, data rate up-to 4800bps.

Operating voltage is 3,3V, current consumption is 17mA in reception, 72mA in transmission (+15dBm ERP).

Module is available in tape & reel package for SMD assembling. Size is 20 x 20 x 2,5 mm.

Main Features

- **40mW max RF output power**
- **Sensitivity -116dBm**
- **Blocking category 1,5**
- **Channels: 5 max**
- **No encoding or preamble requested**
- **UART data rate: 9600 bps**
- **Reduced dimensions (20 x 20 x 2.5 mm)**

The technical features can change without forecasting. AUR°EL S.p.A doesn't assume any responsibility of damage due to the improper use of the device.

Specification

Absolute maximum ratings

	Min.	Typ.	Max.	Unit
Supply Voltage	2.1	3	3.6	V
Input Voltage	-0,5		Vcc+0,6	V
Output Voltage	-0,5		Vcc+0,6	V
Operating temperature	-20		+70	°C
Storage temperature	-40		+100	°C

Table 1: Absolute maximum ratings

DC Characteristics

	Min.	Typ.	Max.	Unit
DC levels				
Supply Voltage pin 9	2.1	3	3.6	V
Current consumption (Rx continuous) ¹		17		mA
Current consumption (Tx continuous) ¹	60	65	75	mA
High level voltage in input	2.0		Vcc	V
Low level voltage in input	0		0.8	V
Pin output current	8			mA

Table 2: DC Characteristics

RF Characteristics

	Min.	Typ.	Max.	Unit
Transmission				
Frequency ¹	868.2		868.4	MHz
RF channels ²		5		
RF power ¹		15	16	dBm
ERP with Aurel antenna "ANT 868 SMA"		15		dBm
Modulation	GFSK			
Deviation GFSK modulation		±3,25		kHz
Channel bandwidth -3dB		11		kHz
Data-rate		4800		bps
Temperature Frequency error 20°C from Freq. channel	-0,8		0,8	KHz
Temperature Frequency stability -20+70°C	-0,6		+0,6	kHz
RF spurious emissions < 1GHz			-36	dBm
RF spurious emissions > 1GHz			-30	dBm
RF spurious, adjacent channel			-40	dBc
Pin 1 ESD contact discharge protection (61000-4-2)		8		kV
Pin 1 ESD air discharge protection (61000-4-2)		15		KV
Other pin than pin1 ESD contact discharge protection		2		KV

The technical features can change without forecasting. AUR°EL S.p.A doesn't assume any responsibility of damage due to the improper use of the device.

Reception	Min.	Typ.	Max.	Unit
RX sensitivity		-115	-119	dBm
RX Bandwidth		11		kHz
Data-Rate		4800		bps
Adjacent channel rejection		37		dB
AFC	-18		+18	kHz
Blocking category ³		1,5		
Blocking test at $\pm 2\text{MHz}$ ³		-12		dBm
Blocking test at $\pm 10\text{MHz}$ ³		3		dBm
Blocking test at $\pm 5\%$ ³		5		dBm
Timing				
SLEEP → RX-ON (no calibration) ⁵ Condition: VCC = 3V (pin 9) SLEEP (pin14) High → Low		4		ms
SLEEP → RX-ON (with calibration procedure) ^{4,5} Condition: VCC = 3V (pin 9) SLEEP (pin14) High → Low		12		ms
RX → TX (from last front on UART RX and Low → High transition on busy pin)			2	ms
TX → RX (busy pin High → Low and start RX)		0,4		ms
off → RX-ON (with calibration procedure) ^{4,5} Condition: VCC = 0 → 3V (pin 9) SLEEP = 0 (pin14)		115		ms

Table 3: RF Characteristics

Note 1: Test carried out with 50 ohm load on pin 1 (antenna).

Note 2: See table 5 for frequency channel values.

Note 3: Test performed in accordance with 5.18 of ETSI EN 300 220-1 V3.1.1 (2017-02)

Note4: Oscillator calibration procedure, performed with jump temperature $> \pm 20^{\circ}\text{C}$

Note5: Firmware 2.1

Pinout

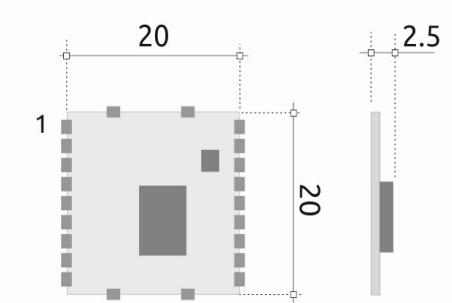

Figure 1: Pin-out and mechanical drawing

1) ANTENNA	12) GND
2) GND	13) NC
3) BUSY	14) SLEEP
4) UART RX	15) RESET
5) UART TX	16) NC
6) CH0	17) NC
7) CH1	18) NC
8) CH2	19) NC
9) VCC	20) GND
10) GND	21) GND
11) GND	22) GND

DXF drawing and Altium compatible PCB footprint are available.

Pin number	Name	Description
1	ANTENNA	Antenna connection, 50 ohm impedance
2	GND	Ground connection
3	BUSY	Uart activity output. When this pin is to high level it isn't possible to send UART data to it (E.g. raised during RF packet transmission or in the calibration procedure)
4	UART RX	Module input for UART data. High impedance input, not internal pull-up or pull-down.
5	UART TX	Module output pin for UART data.
6	CH0	RF channel selection, input active low, internal pull-up.
7	CH1	RF channel selection, input active low, internal pull-up.
8	CH2	RF channel selection, input active low, internal pull-up.
9	VCC	Connection to supply voltage 2,1V-3,6V / 100mA
10	GND	Ground connection
11	GND	Ground connection
12	GND	Ground connection
13	NC	Not used, keep unconnected
14	SLEEP	Sleep input, active High. Drive it to High in order to put module in sleep mode. Keep low for normal operation. High impedance input. ⁽¹⁾
15	RESET	Input reset, active low. Connect to low level to reset the microcontroller, keep open in normal condition.
16	NC	Not used, keep unconnected
17	NC	Not used, keep unconnected
18	NC	Not used, keep unconnected
19	NC	Not used, keep unconnected
20	GND	Ground connection
21	GND	Ground connection
22	GND	Ground connection

⁽¹⁾ User has to connect the pin to High level in sleep mode. When the pin sleep (pin14) is connect to Low level it goes in reception mode.

Table 4: Pin function description

The technical features can change without forecasting. AUR^oEL S.p.A doesn't assume any responsibility of damage due to the improper use of the device.

UART Operation

The RTX-868-NB-UART is a radio modem working in packet mode, maximum length is 64 byte. Data is been exchange between RTX-868-NB-UART and the host microprocessor using a UART with 9600 bps 8,N,1 configuration.

Transmission

To transmit a packet the host processor has to send UART data on module pin 4. When the last byte is transferred and after about 1,8mS the pin Busy go to high level, the RTX-868-NB-UART start the RF encapsulation of the data adding preamble, synch word, CRC and start the RF transmission. In the RF transmission the module can't accept more data on UART, the pin BUSY goes to high level in order to indicates to the user to stop the operation in the RX-UART pin.

In case that host microprocessor start to send UART data while the module is receiving a RF packet, this received data is discarded.

Reception

When an RF packet is received, the RTX-868-NB-UART decode, validated it and transmitted to the host microprocessor via UART TX (pin 5); in the UART transferring operation the host microprocessor can't send data to the module (pin 4 UART RX), this is signalled with high level on the BUSY pin. The BUSY pin will switch to low level when the module is ready to accept data from UART.

RF channel selection

CH0, CH1 and CH2 pins allow the user to select the RF channel frequency operation, they are available as shown in Table 5.

Channel setup is read by the module only in the power up phase, after a reset or in sleep mode. It isn't possible to change the channel runtime, RX-ON or TX-ON.

When the pin sleep is connected to Low level it goes in reception mode, together the RF CH pins must to connected to low or high level in order to setup the wanted RF channel.

To limit the consumption in sleep-mode, RF CH Sel pins (pin 6-7-8) are normally in high impedance, the user must connect them to low level

Channel Number	CH2 Pin 8	CH1 Pin 7	CH0 Pin 6	RF channel (MHz)
1	0	0	0	868.2
2	0	0	1/X	868.25
3	0	1/X	0	868.3
4	0	1/X	1/X	868.35
5	1/X	0	0	868.4

0 = GND, 1 = Vcc, X = Open

Table 5: RF channel selection

The technical features can change without forecasting. AUR°EL S.p.A doesn't assume any responsibility of damage due to the improper use of the device.

Sleep mode

The module can be put in low power consumption mode driving the sleep pin accordingly, if no sleep-mode is needed it must be connected to GND.

Driving to high level the sleep pin the module enters in sleep mode with a current consumption of about 1,5uA. In this state no data reception or transmission is allowed.

Driving the pin to low level, in about 3ms the device enters in RX mode ready to use.

Oscillator calibration procedure

In order to guarantee stable operation on UART communication the module integrates an oscillator that checks temperature and performs cycles calibration.

The condition of calibration is the following:

1. In RX-ON when the temperature change of $\pm 20^{\circ}\text{C}$ from last calibration
2. After wake-up from sleep, if the module detects a drift of temperature $> \pm 20^{\circ}\text{C}$ from the temperature detected before last Sleep condition.
3. In Power-ON operation (V_{cc} pin9, $0V \rightarrow V_{cc}$) or after a RESET transition (Pin15, $0V \rightarrow +V_{cc}$).

The calibration procedure takes about 12ms, during the procedure the pin BUSY goes to high level the module is in Idle mode not able to receive or transmit.

In Power on operation (V_{cc} pin9, $0V \rightarrow V_{cc}$) the procedure time increases up to 115ms.

Reset operation

The pin 15 (RESET) of the module is available to reset the internal microcontroller, keep it to low level to reset the microcontroller keep it open for normal operation.

The device is protected for voltage supply drops by a voltage detector, in order to guarantee correct operation every time the device is reset it sends on UART TX (pin 5) the message in Ascii code with module name and firmware version.

The device integrates a supervision voltage reset circuit, under 1,8V the device is kept in reset mode and the voltage supply of the radio IC is forced to GND.

Device usage

In order to obtain the performances described in the technical specifications and to comply with the operating conditions which characterize the certification, the transceiver should be mounted on a printed circuit taking into account the following:

Power Supply

1. RTX-868-NB-UART must be supplied from very low voltage safety source protected against the short circuits. Maximum voltage variations allowed: $2.1 \div 3.6$ V. However it is preferable to maintain a stable voltage to a predetermined value in the range of voltage as specified above, using a "fast transient response" voltage regulator.
2. Decoupling, close to the transceiver, with a ceramic capacitor of minimum 100nF.
3. Connect electrolytic capacitor 100uF, low ESR, close to pin 9 (V_{cc}).

The technical features can change without forecasting. AUR°EL S.p.A doesn't assume any responsibility of damage due to the improper use of the device.

Input pin interface

Put 100pF capacitors close to the corresponding general purpose digital inputs pins, connected between them and the ground plane.

Ground

The ground must surround at the best the welding area of the module and must also be realized in the lower face of the PCB in order to allow the optimal result, with the through holes connecting the two ground planes.

Antenna

Connect pin 1 (antenna) to the coaxial connector or antenna, with 50 ohm constant impedance microstrip width 3.2 mm for PCB with thickness 1.6 mm and width 1.6 mm for PCB with thickness 1mm.

The antenna is a typical rigid copper wire (insulated or not) of 8cm length and cross-section at least of 0.5 mm² placed vertically to the ground plane. Other placements of antenna (bend, coil) will work but performance are not predictable.

As an alternative to connect the module to an external antenna, connect an SMA connector into PCB using 50 ohm microstrip line.

Development board

Here follow a simple diagram circuit to test the RTX-NB-868-UART.

The module is connected to "FT232RL" UART to USB interface IC, the channel are selectable by the dip-switch S1, J2 allows to test the power-down function.

Using a PC with terminal software and an USB cable connected to J3 connector, it is possible transmit and receive data packet.

More details about this application is available on RTX-NB-868-UART Demo board user manual.

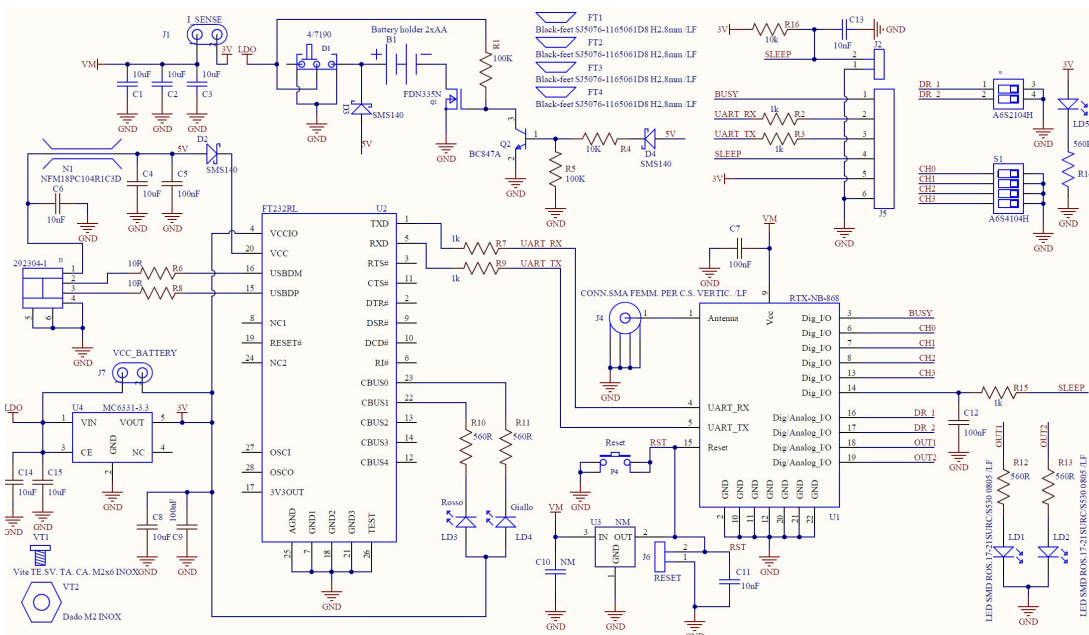
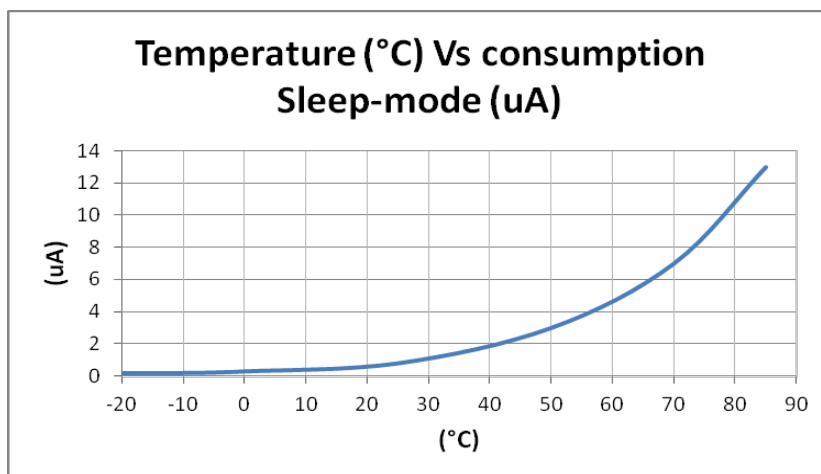
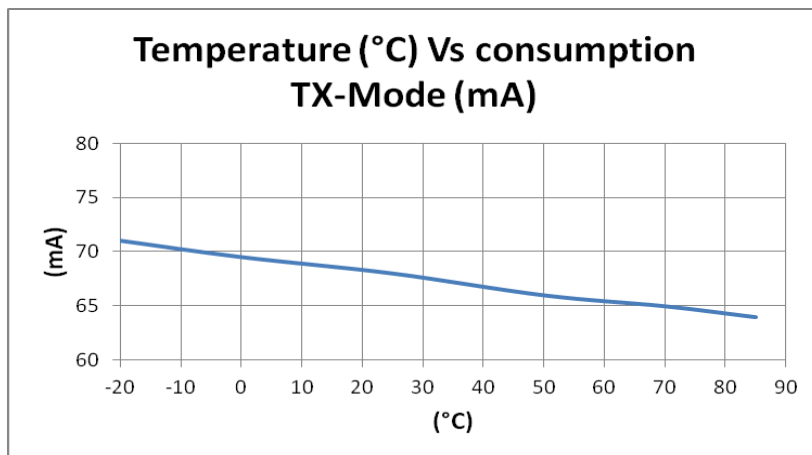
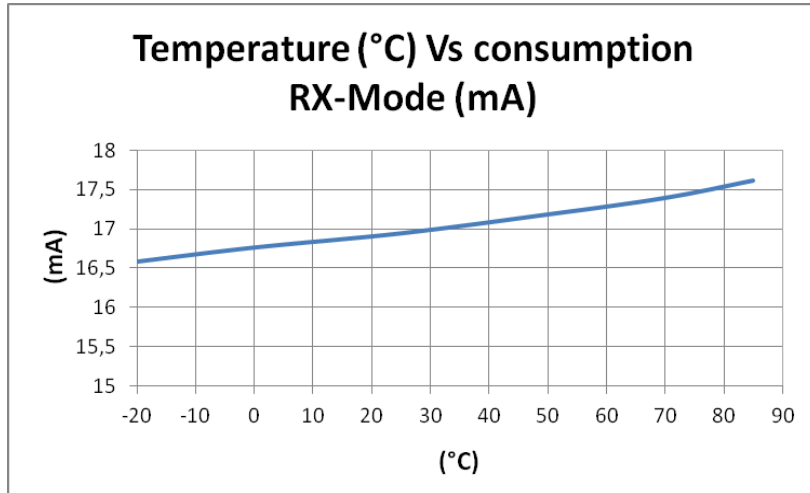

Figure 2: Demo-Board diagram circuit

The technical features can change without forecasting. AUR^oEL S.p.A doesn't assume any responsibility of damage due to the improper use of the device.

Typical operating characteristics



The technical features can change without forecasting. AUR°EL S.p.A doesn't assume any responsibility of damage due to the improper use of the device.

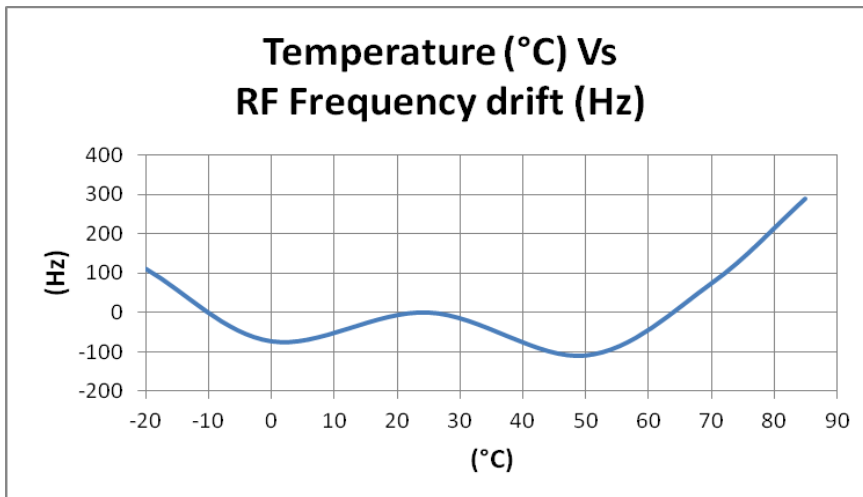
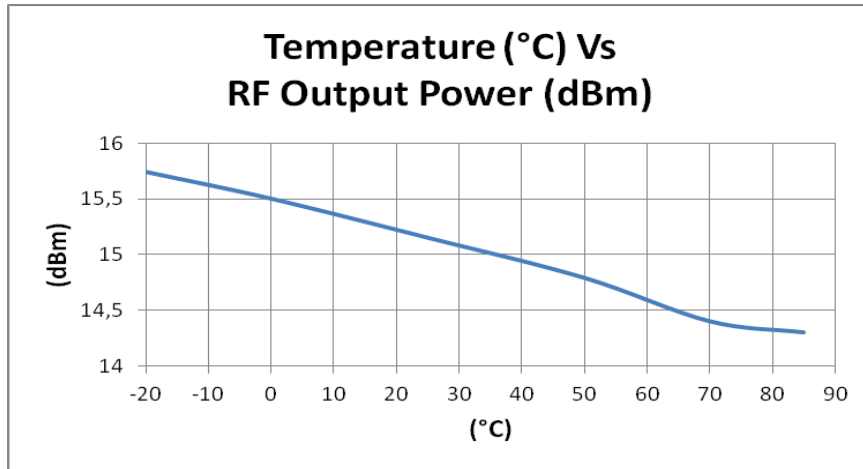

Note: Temperature RF drift frequency from reference at 25°C

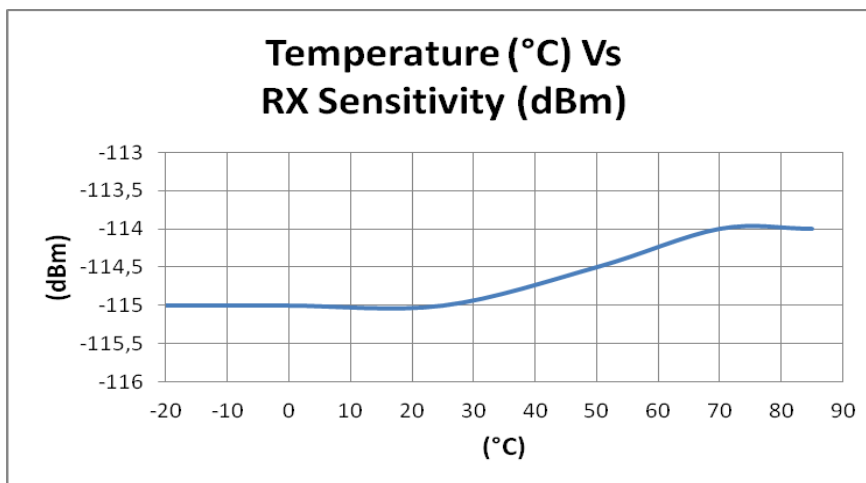

The technical features can change without forecasting. AUR°EL S.p.A doesn't assume any responsibility of damage due to the improper use of the device.

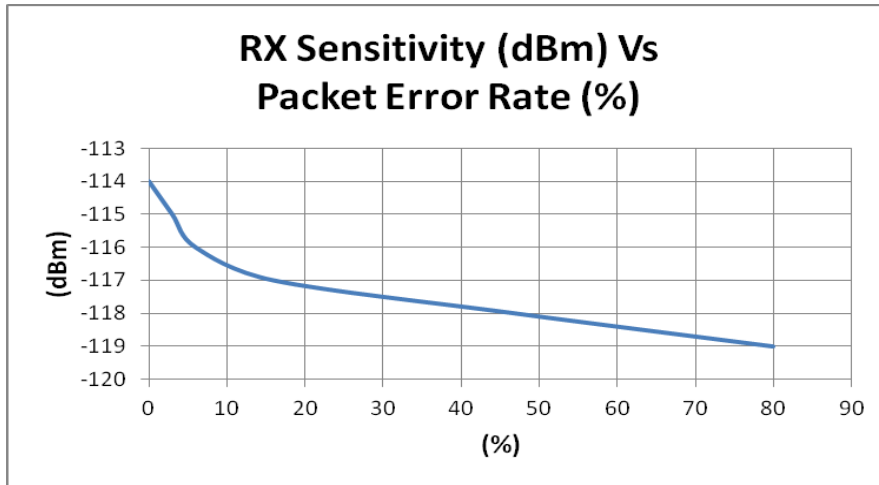

Note: The test is performed with 1000 packet 10 byte length

Soldering and assembling layout SMD

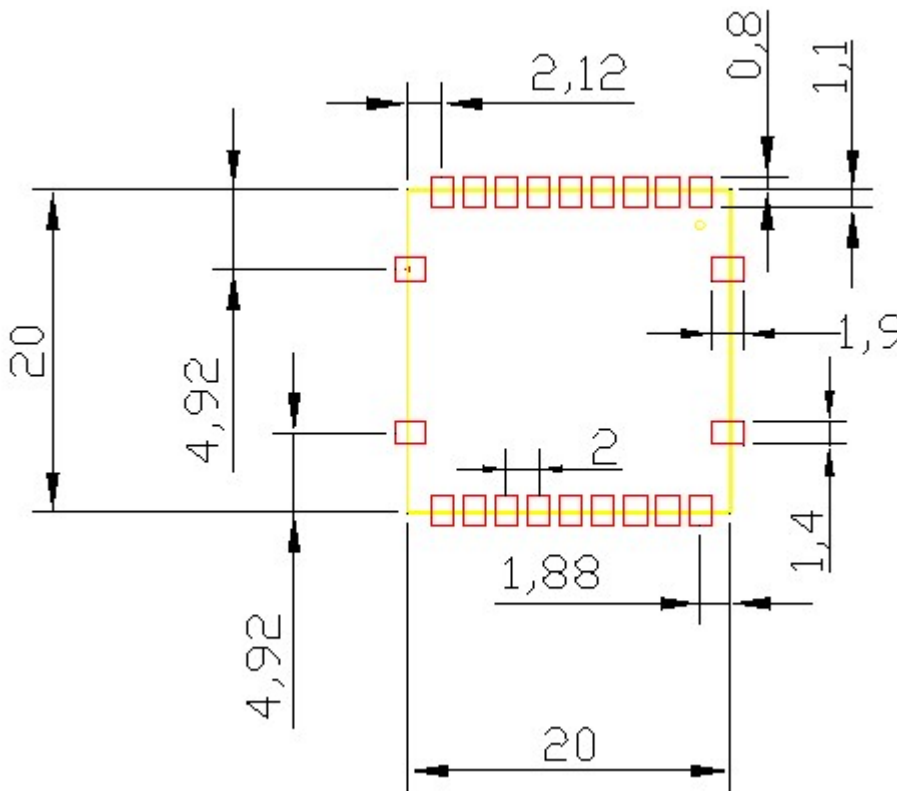

Figure 3: recommended layout for Host board (quote in mm)

The technical features can change without forecasting. AUR°EL S.p.A doesn't assume any responsibility of damage due to the improper use of the device.

In order to ensure the correct assembly of the module you are required to apply a production process observing carefully the following recommendations:

- **Soldering paste:** Use soldering paste as SAC305 (96,5% Sn, 3% Ag, 0,5% Cu), screen printed according the layout of Picture 8, with a thickness > 150um.
- **Assembly:** the module can be assembled with automatic machine by using a suction cup tool, applied on bigger integrated circuit
- **Soldering:** the module can be soldered on host board, through a reflow profile for Lead-free components.

Jedec standard "J-STD-020E"

Lo standard Jedec "J-STD-020E" defines temperatures and exposure times, is attached below graph and profile table time / temperature recommended for the purpose.

For host that provide more reflow cycles it is recommended to perform the soldering of the module at the end of the soldering cycle, taking care to limit excessive vibrations during the terminal phase of reflow soldering paste.

Profile Feature	Pb-Free Assembly
Preheat/Soak	
Temperature Min (T _{smin})	150 °C
Temperature Max (T _{smax})	200 °C
Time (ts) from (T _{smin} to T _{smax})	60-140 seconds
Ramp-up rate (TL to T _p)	2 °C/second max.
Liquidous temperature (TL)	217 °C
Time (tL) maintained above TL	60-150 seconds
Peak package body temperature (T _p)	240°
Time (t _p)* within 5 °C of the specified classification temperature (T _c), see Figure 9.	30* seconds
Ramp-down rate (T _p to TL)	6 °C/second max.
Time 25 °C to peak temperature	5 minutes max.
* Tolerance for peak profile temperature (T _p) is defined as a supplier minimum and a user maximum.	

Table 6: Detailed time / temperatures profile for soldering RTX-NB-868-UART

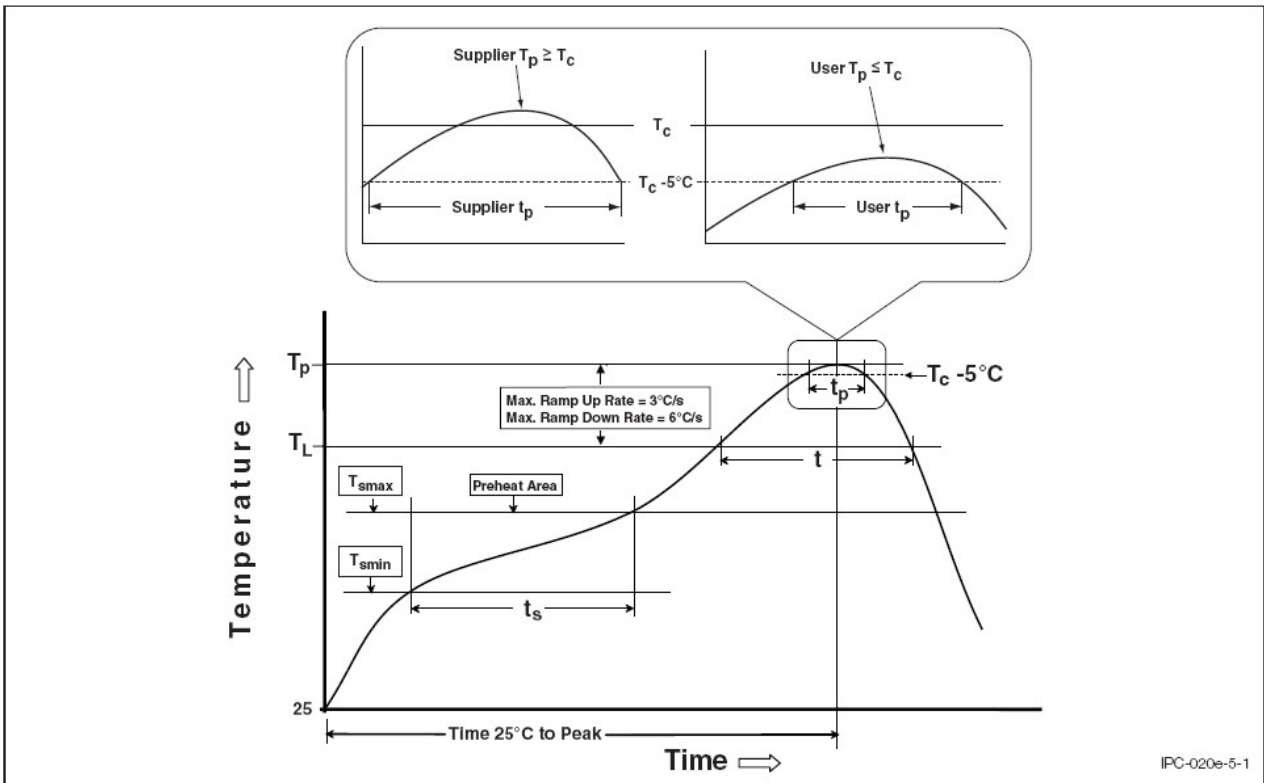

Figure 4: Soldering profile for RTX-NB-868-UART

Specifications Packaging Tape and Reel:

RTX-868-NB-UART is packed in Tape and Reel composed by an embossed carrier tape and antistatic cover tape.

In this way the modules are ESD protected and can be handled by machines for the automatic assembly of SMD components.

Dimensions:

- W = 44 mm
- P = 28 mm
- T = 0,4 mm
- Ao = 20,5 mm
- Bo = 20,5 mm
- Ko = 2,7 mm

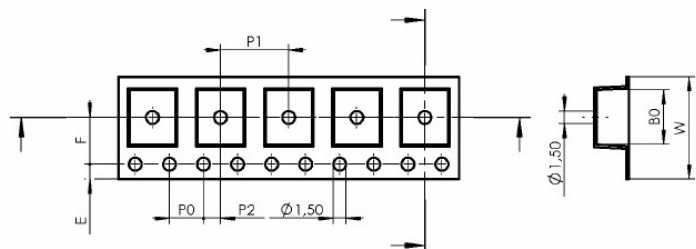

Picture 5: Tape and Reel drawing (in mm)

The technical features can change without forecasting. AUR°EL S.p.A doesn't assume any responsibility of damage due to the improper use of the device.

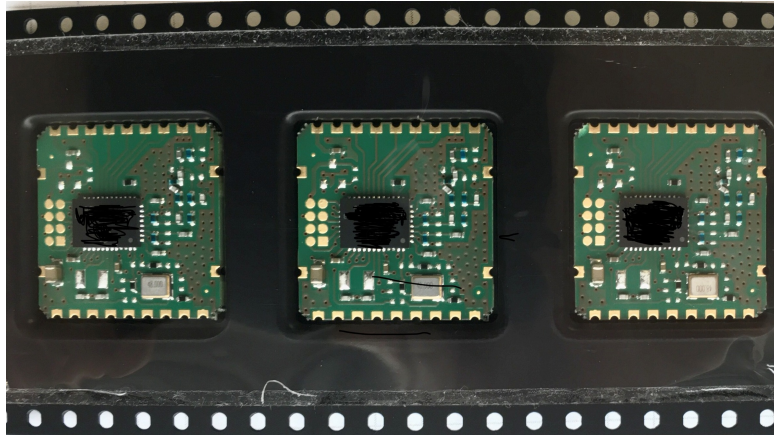

Picture 6: External aspect of the embossed

Normative reference

RTX-868-NB-UART transceiver is compliant with the European set of rules **EN 300 220-2**, and **EN 301 489-3**. The transceiver must be supplied by a very low voltage safety source protected against short circuits. The usage of the module is foreseen inside enclosures that guarantee the **EN 61000-4-2** normative not directly applicable to the module itself. This device is compliant with **EN 62479**, connected to the electromagnetic field human exposition, if used with temporal duty cycle not higher than 1% like foreseen in CEPT 70-03 recommendation.

CEPT 70-03 Recommendation

RTX-868-NB-UART recommendation is referred to the 868.0 – 868.6 MHz harmonized bandwidth and therefore, in order to comply with local regulations, the device must be used on the time scale with maximum duty-cycle time of 1% (equivalent to 36 seconds of usage on 60 minutes).

The technical features can change without forecasting. AUR°EL S.p.A doesn't assume any responsibility of damage due to the improper use of the device.

User manual revision summary

Release date	Revision	Description
20191107	1.0	First preliminary draft
20201120	2.0	Change product Name Oscillator calibration Development board Soldering and assembly
23022021	2.1	Firmware rel.2.1 Inverted the logic of the pin sleep (14) Insert paragraph Typical operating characteristics Insert paragraph Reset
28052021	2.2	Firmware rel.2.2 Inverted function pin sleep Changed Timing parameters (Table 3)
29092021	2.3	Firmware rel.2.2 Table 5: change state X = open, alternative to 1 = Vcc

The technical features can change without forecasting. AUR°EL S.p.A doesn't assume any responsibility of damage due to the improper use of the device.

X-ON Electronics

Largest Supplier of Electrical and Electronic Components

Click to view similar products for [RF Modules](#) category:

Click to view products by [Aurel](#) manufacturer:

Other Similar products are found below :

[2221706-1](#) [RAD-900-DAIO6](#) [650200791G](#) [650200714G](#) [RFM95PW-915S2](#) [VG2389S433N0S1](#) [VG6244S580X0M1](#) [RC-WLE5-868-HA](#)
[RFM219BW-868S2](#) [E49-900M20S](#) [E01-2G4M27SX](#) [DL-297LDA-S](#) [DL-24PA-C](#) [DL-Si24R1-A](#) [VG3411S433N0S1](#) [HY831S](#) [TR1101](#)
[VG4130S433N0S1](#) [VG4142T868N0M1](#) [VG3411S915N0S1](#) [E310-433T23S](#) [E43-900T13S3](#) [E07-400MM10S](#) [DL-PAN3029-S-915S](#) [DL-](#)
[PAN3029-S-433S](#) [E01C-2G4M11S](#) [DL-PAN3029-S-868S](#) [E70-433MT14S](#) [E03-2G4M10S](#) [E01C-ML01S](#) [E610-433T20S](#) [E610-](#)
[DTU\(433C30\)](#) [E01-2G4M13S](#) [E30-400M20S\(4463\)](#) [E49-400M30S](#) [E31-230T27D](#) [E41-400M20S](#) [E07-900MM10S](#) [E01-2G4M20S1B](#) [E70-](#)
[900T14S](#) [E01C-ML01D](#) [E49-400T30S](#) [E30-170T27D](#) [E62-433T30D](#) [E21-400G30S](#) [E07-900T10S](#) [E04-400M16S](#) [E01-ML01DP4](#) [E610-](#)
[433T30S](#) [E29-400M22S](#)